

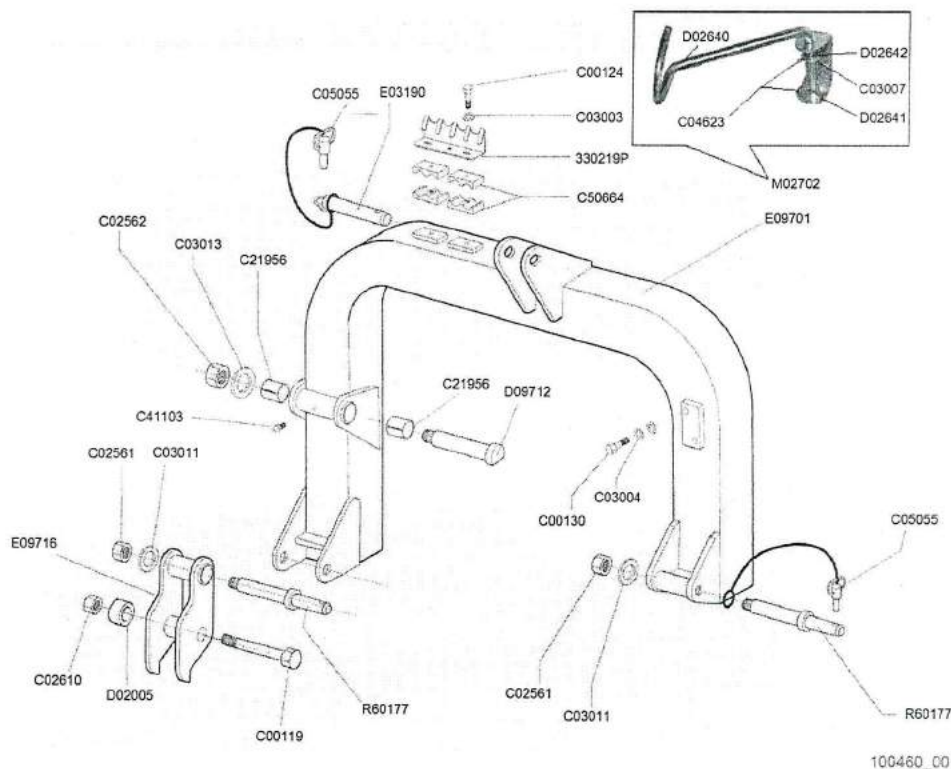

















3 Point linkage



100460_00

	New Code (9 digits)	Old Code	Description	Unit of measure	Qty
	330219P		PORTACONDOTTE TL/TR SP3MM ZINC.	nr.	1
	C00119	M80A00108	SCREW TE 88 PG FP M24X170 ZINC UNI 5737	nr.	1
	C00124	M80A00113	SCREW TE 88 PG FT M8X35 ZINC UNI 5739	nr.	1
	C00130	M80A00117	SCREW TE 88 PG FT M10X20 ZINC UNI 5739	nr.	1
	C02561	M85A00069	NUT AUTOBLOC BASSO 8 PF M27X2 H=22.5 UNI 7474	nr.	1
	C02562	M85A00070	NUT AUTOBLOC BASSO 8 PF M30X2 H=23 UNI 7474	nr.	1
	C02610	M85A00083	NUT AUTOBLOC ALTO 10 M24 H=28 UNI 7473	nr.	1
	C03003	M90A00005	WASHER PIANA D.8,4 DIN125-A ZINC.	nr.	1
	C03004	M90A00007	WASHER PIANA D.10,5 DIN125-A ZINC.	nr.	1
	C03007	M90A00010	WASHER PIANA D.17 DIN125-A ZINC.	nr.	1
	C03011	M90A00014	WASHER PIANA D.28 DIN125-A ZINC.	nr.	1
	C03013	M90A00016	WASHER PIANA D.31 DIN 125-A ZINC.	nr.	1

C04623	 MB0A00060	C04623	SOCKET SPIROL D.6X40	nr.	1
C05055	 MB0A00096	C05055	SOCKET A SCATTO D.10 CON TIRANTE IN GOMMA	nr.	1
C21956	 M25A00004	C21956	BUSH ALVEOLATA 40-40 KX 22	nr.	1
C41103	 MJ5A00003	C41103	GREASE NIPPLE MBX1.25 DRITTO ESAGONO 11.	nr.	1
C50664	 G10A00033	C50664	"METAL RING FERMATUBI POLIPROP. 2 X1/4" (COMPL)"	nr.	1
D02005	 C15A00122	D02005	SPACER D.40 d.25,5 L.20	nr.	1
D02640	 C10A01221	D02640	HOOK SOSTEGNO CARDANO	nr.	1
D02641	 C10A01223	D02641	BRACKET SOSTEGNO CARDANO sp6mm	nr.	1
D02642	 MF5A00017	D02642	SPRING DI.18 L.36 FILO D.3	nr.	1
D09712	 M15A00118	D09712	PIN D.40X182 UT. ESTR. M30X2	nr.	1
E03190	 M15A00172	E03190	PIN ROND.25X109 UT.FORO D.12 ZINC***	nr.	1
E09701	 C20A01667	E09701	FRAME TERZO PUNTO TL30/TL32	nr.	1
E09716	 C20A01669	E09716	CONNECTING ROD X ATTACCO TRATTORE DESTRO TL30/32	nr.	1
M02702	 M79A00013	M02702	HOOK SUPP. CARDANO COMPL.***	nr.	1
R60177	 M15A00194	R60177	PIN ATTACCHI INF.TL30/32	nr.	1



Sideway swivel

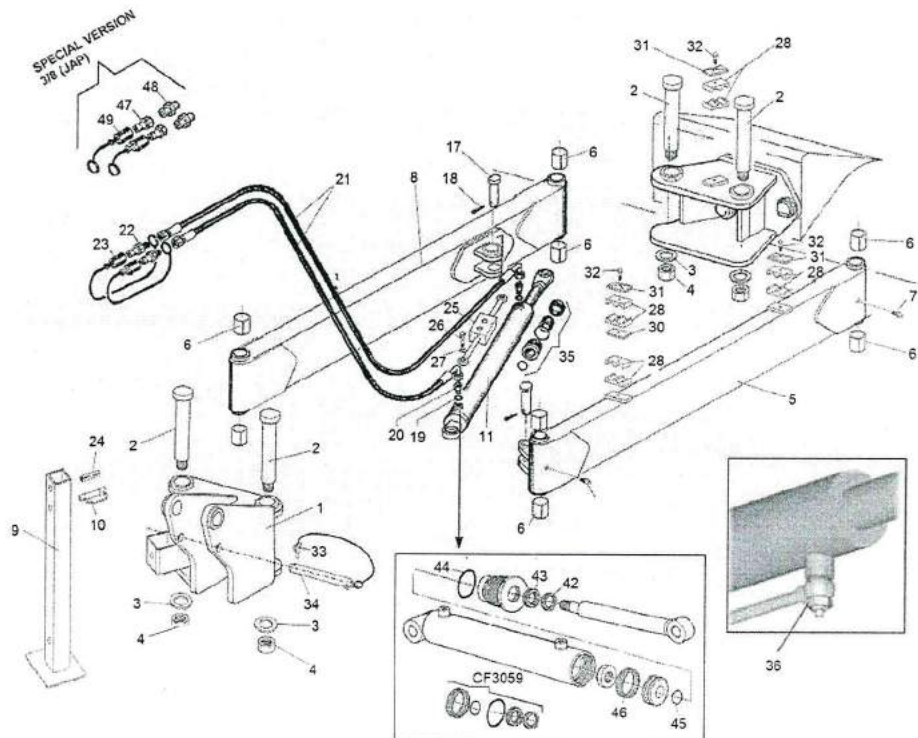

100461_00

	 New Code (9 digits)	Old Code	Description	Unit of measure	Qty
1	 C20A02529	R60505	SUPPORT ANTERIORE SPOST.LATERALE TL30-TL32	nr.	1
2	 M15A00189	R60136	PIN BRACCI PARAL SPOST LAT TL30	nr.	1
3	 M90A00014	C03011	WASHER PIANA D.28 DIN125-A ZINC.	nr.	1
4	 M85A00069	C02561	NUT AUTOBLOC BASSO 8 PF M27X2 H=22.5 UNI 7474	nr.	1
5	 C20A02530	R60506	ARM PARALLELOGRAMMA SINISTRO TL30-TL32	nr.	1
6	 M25A00003	C21955	BUSH ALVEOLATA 35-40 KX 22	nr.	1
7	 MJ5A00003	C41103	GREASE NIPPLE M8X1.25 DRITTO ESAGONO 11.	nr.	1
8	 C20A02537	R60519	ARM PARALLELOGRAMMA DESTRO TL32	nr.	1
9	 C20A02532	R60508	FOOT DI SOSTEGNO TL30-TL32	nr.	1
10	 MB0A00099	C05078	PIN PER MOTOZAPPA D.8X60 UTILE	nr.	1
11	 H80A00059	R60473	CYLINDER D.60 C320 S30 CON ROTULE D26	nr.	1
17	 M15A00190	R60137	PIN MARTINETT STELO CIL SPOST LAT TL30	nr.	1
18	 MB5A00021	C04843	COTTER PIN D.6,3X50 UNI 1336	nr.	1

19		H35A00042	C40382	WASHER RAME 3/8 D.17	nr.	1
20		H35A00009	C40309	NIPLES RIDUZ.1/4 3/8	nr.	1
21		H75A00086	M10403	"TUBE IDR F90°1/4""-R1ATX2850-FD M18X1.5 DIN 2353"	nr.	1
22		H50A00007	C41512	COUPLING RAPIDO MASCHIO ATT.M18X1.5 DIN 2353	nr.	1
23		G10A00002	C41520	PLUG PROT.INNESTO RAPIDO 1/2 MASCHIO BLU	nr.	1
24		MB0A00015	C04523	SOCKET ELASTICA D.6X40	nr.	1
25		H70A00016	C40724	VALVE BLOCCO VBPDE 3/8L 2C.EX.C	nr.	1
26		H40A00002	C40341	SCREW FORATA 3/8X31	nr.	1
27		H35A00042	C40382	WASHER RAME 3/8 D.17	nr.	1
28		G10A00033	C50664	"METAL RING FERMATUBI POLIPROP. 2 X1/4"" (COMPL)"	nr.	1
30		C15A00018	C50662	BASE FERMATUBO POLIP. 2 TUBI VITE M8	nr.	1
31		C15A00017	C50661	LID FERMATUBO POLIPROP. 2 TUBI	nr.	1
32		M80A00008	C00011	SCREW TE 88 PG FP M8X60 ZINC UNI 5737	nr.	1
33		MB0A00096	C05055	SOCKET A SCATTO D.10 CON TIRANTE IN GOMMA	nr.	1
34		M15A00119	D09717	PIN ROND D.25X170 UT FORO D.12	nr.	1
35		SCOA00064	CF3059	SERIES GUARNIZIONI CIL.TL30/32 D.60 D.30	nr.	1
36		H40A00001	C40340	SCREW FORATA 3/8X31 CON STROZZATORE	nr.	1
42		H20A00025	C11333	SCRAPER 118149 D.38.6x30x5.3	nr.	1
43		H20A00013	C11227	GASKET STELO B 157118 D.40x30x7.5	nr.	1
44		H05A00019	C10516	RING OR (832) 156 D.INT.52.39x3.53	nr.	1
45		H05A00002	C10495	RING OR (119) 3093 D.INT.23.47X2.62	nr.	1
46		H20A00018	C11235	GASKET PISTONE TPM-9020 236173 D.60X44X18.4	nr.	1
47		H50A00004	C41509	COUPLING RAPIDO MASCHIO ATT. ANV3/8GAS	nr.	1
48		H35A00096	C40511	NIPLES 3/8 CON OGIVA 12 TENUTA DIN 3852 FORMA E CON GUARNIZIONE	nr.	1
49		G10A00006	C41524	PLUG PROT.INNESTO RAPIDO 3/8 MASCHIO	nr.	1





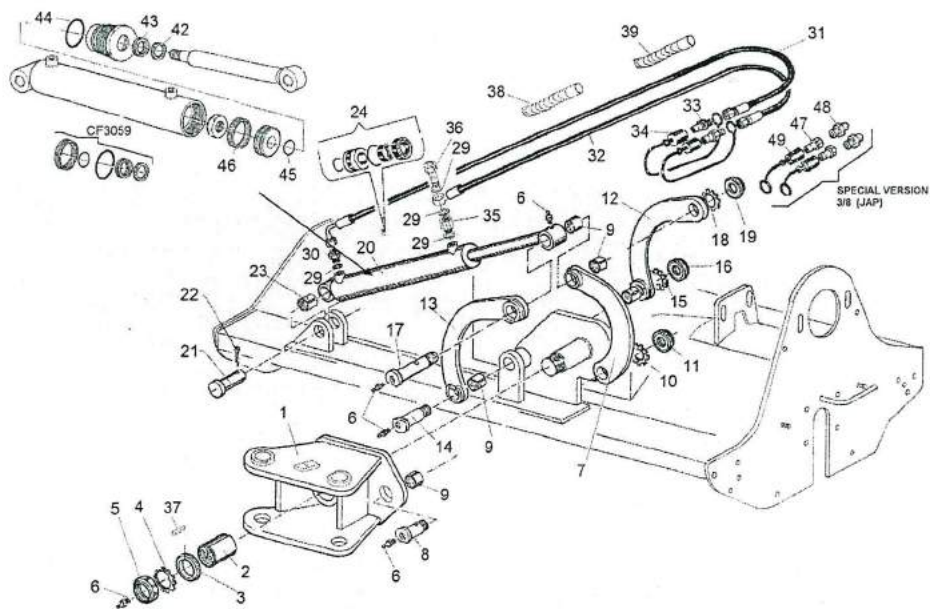



























Frame over turn



100462_00

		New Code (9 digits)	Old Code	Description	Unit of measure	Qty
1		C20A02516	R60300	CONNECTION POSTERIORE COMPL.RIB.TELAIO TL30	nr.	1
2		M25A00005	C21980	BUSH ALVEOLATA 7080 KX 22 (DI=70 DE=75 L=80)	nr.	1
3		M25A00024	R60231	BUSH PERNO SNODO TL32	nr.	1
4		M95A00021	C03702	WASHER MB 12 PER KM 60 ZINC	nr.	1
5		M95A00016	C03538	METAL RING AUTOBLOC.ALTA GUP M60X2	nr.	1
6		MJ5A00003	C41103	GREASE NIPPLE M8X1.25 DRITTO ESAGONO 11.	nr.	1
7		C20A02525	R60494	CONNECTING ROD CENTRALE RIBALT.TELAIO TL (20)	nr.	1
8		M15A00191	R60138	PIN X BIELLA SIN RIBALT TELAIO TL-30	nr.	1
9		M25A00002	C21950	BUSH ALVEOLATA 35-35 KX 22	nr.	1
10		M95A00020	C03701	WASHER MB 7 PER KM 35 ZINC	nr.	1
11		M95A00004	C03513	METAL RING AUTOBLOC.BASSA GUK M35X1,5	nr.	1

12	 C20A03264		CONNECTING ROD POSTERIORE DESTRA RIBALT. TL DOM.(10)	nr.	1
13	 C20A03263		CONNECTING ROD ANTERIORE RIBAL. TELAIO TL DOM.(10)	nr.	1
14	 M15A00192	R60139	PIN X BIELLE DES RIBALT TELAIO TL-30	nr.	1
15	 M95A00020	C03701	WASHER MB 7 PER KM 35 ZINC	nr.	1
16	 M95A00004	C03513	METAL RING AUTOBLOC.BASSA GUK M35X1,5	nr.	1
17	 M15A00193	R60140	PIN SUPERIORE BIELLE RIBAL-TELAIO TL30	nr.	1
18	 M95A00020	C03701	WASHER MB 7 PER KM 35 ZINC	nr.	1
19	 M95A00004	C03513	METAL RING AUTOBLOC.BASSA GUK M35X1,5	nr.	1
20	 H80A00060	R60474	CYLINDER D.60 C260 S30 D.35	nr.	1
21	 M15A00121	D09769	PIN D.35X70 UT.FORO D.6 ZINC	nr.	1
22	 MB5A00022	C04844	COTTER PIN D.6,3X60 UNI 1336	nr.	1
23	 M25A00003	C21955	BUSH ALVEOLATA 35-40 KX 22	nr.	1
24	 SCOA00064	CF3059	SERIES GUARNIZIONI CIL.TL30/32 D.60 D.30	nr.	1
29	 H35A00042	C40382	WASHER RAME 3/8 D.17	nr.	1
30	 H35A00009	C40309	NIPLES RIDUZ.1/4 3/8	nr.	1
31	 H75A00085	M10402	"TUBE IDR F90°1/4"-R1ATX4350-FD M18X1.5 DIN 2353"	nr.	1
32	 H75A00084	M10401	"TUBE IDR OH3/8"-R1AT 1/4"X3950-FD M18X1.5 DIN 2353"	nr.	1
33	 H50A00007	C41512	COUPLING RAPIDO MASCHIO ATT.M18X1.5 DIN 2353	nr.	1
34	 G10A00002	C41520	PLUG PROT.INNESTO RAPIDO 1/2 MASCHIO BLU	nr.	1
35	 H70A00011	C40714	VALVE PARACADUTE (TAR1.5) COLON. 3/8H=40MM TEN. DIN FOR.A	nr.	1
36	 H40A00001	C40340	SCREW FORATA 3/8X31 CON STROZZATORE	nr.	1
37	 MC0A00005	C04908	TONGUE 8X7X12.5 UNI 6604A	nr.	1
38	 G10A00037	C50680	"SPIRAL PROTEZ. TUBI IDR. 20X16 1/4""	mt.	1
39	 G10A00037	C50680	"SPIRAL PROTEZ. TUBI IDR. 20X16 1/4""	mt.	1
42	 H20A00025	C11333	SCRAPER 118149 D.38.6x30x5.3	nr.	1
43	 H20A00013	C11227	GASKET STELO B 157118 D.40x30x7.5	nr.	1
44	 H05A00019	C10516	RING OR (832) 156 D.INT.52.39x3.53	nr.	1
45	 H05A00002	C10495	RING OR (119) 3093 D.INT.23.47X2.62	nr.	1
46	 H20A00018	C11235	GASKET PISTONE TPM-9020 236173 D.60X44X18.4	nr.	1
47	 H50A00004	C41509	COUPLING RAPIDO MASCHIO ATT. ANV3/8GAS	nr.	1
48	 H35A00096	C40511	NIPLES 3/8 CON OGIVA 12 TENUTA DIN 3852 FORMA E CON GUARNIZIONE	nr.	1
49	 G10A00006	C41524	PLUG PROT.INNESTO RAPIDO 3/8 MASCHIO	nr.	1



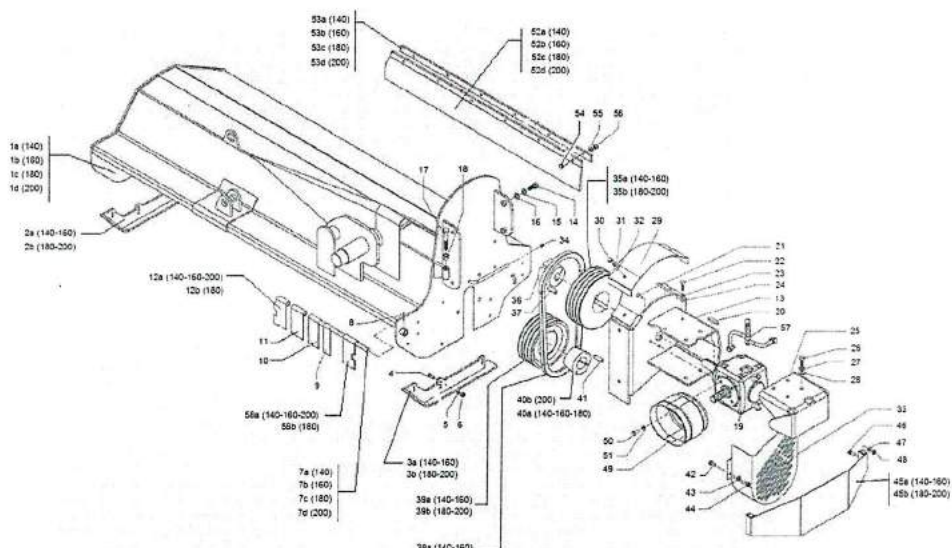

Frame and pulley transmission



100554_00

		New Code (9 digits)	Old Code	Description	Unit of measure	Qty
1a		C20A02538	R60520	FRAME COMPLETO TL32-140	nr.	1
1b		C20A02539	R60521	FRAME COMPLETO TL32-160	nr.	1
1c		C20A02540	R60522	FRAME COMPLETO TL32-180	nr.	1
1d		C20A02541	R60523	FRAME COMPLETO TL32-200	nr.	1
2a		C20A02484	R60100	SKID DESTRA TL30-140/160	nr.	1
2b		C20A02485	R60101	SKID DESTRA TL31-33-180/200	nr.	1
3a		C20A02486	R60102	SKID SINISTRA TL30-140/160	nr.	1
3b		C20A02487	R60103	SKID SINISTRA TL31-33-180/200	nr.	1
4		M80A00120	C00132	SCREW TE 88 PG FT M10X30 ZINC UNI 5739	nr.	1
5		M90A00007	C03004	WASHER PIANA D.10,5 DIN125-A ZINC.	nr.	1
6		M85A00077	C02604	NUT AUTOBLOC ALTO 8 M10 H=11.5 UNI 7473	nr.	1
7a		C15A00880	R60258	ROD SOSTEGNO BANDIERINE D.16 L=1414 ZINC.	nr.	1
7b		C15A00881	R60259	ROD SOSTEGNO BANDIERINE D.16 L=1614 ZINC.	nr.	1

7c		C15A00882	R60260	ROD SOSTEGNO BANDIERINE D.16 L=1814 ZINC.	nr.	1
7d		C15A00883	R60261	ROD SOSTEGNO BANDIERINE D.16 L=2014 ZINC.	nr.	1
8		M80A00013	C04521	SOCKET ELASTICA D.6X30	nr.	1
9		C10A03438	R60143	PLATE DI PROT. 60X4X182	nr.	1
10		C10A03436	R60141	PLATE DI PROT. 120X4X182	nr.	1
11		C10A03437	R60142	PLATE DI PROT. 140X4X182	nr.	1
12a		C10A03439	R60178	PLATE DI PROT. 120X4X182 2 SCANT	nr.	1
12b		C10A03453	R60528	PLATE DI PROT. 140X4X182 2 SCANT	nr.	1
13		C20A01670	E09735	SKID SUPPORTO MOLTIPLICATORE TL33	nr.	1
14		M80A00137	C00152	SCREW TE 88 PG FT M14X35 ZINC UNI 5739	nr.	1
15		M90A00046	C03156	WASHER GROWER RINF. D.14 ASA B27 ZINCO-LAMELLARE	nr.	1
16		M90A00030	C03054	WASHER PIANA D16XD42X2.5 UNI 6593 ZINC	nr.	1
17		M80A00153	C00167	SCREW TE 88 PG FT M16X80 ZINC UNI 5739	nr.	1
18		M85A00029	C02106	NUT NORMALE 8 PG M14 UNI 5588	nr.	1
19		M65A00100	M06932	MULTIPLIER R240 SINISTRO-1/3-RL-D33	nr.	1
20		MC0A00004	C04907	TONGUE 10X8X60 UNI 6604	nr.	1
21		M80A00283	C00630	SCREW TSPEI 10.9 PG M10X25 ZINC UNI 5933	nr.	1
22		M80A00129	C00142	SCREW TE 88 PG FT M12X30 ZINC UNI 5739	nr.	1
23		M90A00035	C03105	WASHER GROWER D.12 DIN 127	nr.	1
24		M90A00008	C03005	WASHER PIANA D.13 DIN125-A ZINC.	nr.	1
25		C10A00759	330086P	PROTECTION LAT. TL32 04824 SP6MM ZINC.	nr.	1
26		M80A00131	C00144	SCREW TE 88 PG FT M12X40 ZINC UNI 5739	nr.	1
27		M90A00035	C03105	WASHER GROWER D.12 DIN 127	nr.	1
28		M90A00008	C03005	WASHER PIANA D.13 DIN125-A ZINC.	nr.	1
29		C10A00758	330085P	GATE SUP. TL32 04738/1 SP2MM ZINC.	nr.	1
30		M80A00118	C00131	SCREW TE 88 PG FT M10X25 ZINC UNI 5739	nr.	1
31		M90A00034	C03104	WASHER GROWER D.10 DIN 127	nr.	1
32		M90A00007	C03004	WASHER PIANA D.10,5 DIN125-A ZINC.	nr.	1
33		C20A01405	E07958	HOUSING COMPL. TL32 (SEMICARTER)***	nr.	1
34		M15A00003	C41103	GREASE NIPPLE M8X1.25 DRITTO ESAGONO 11.	nr.	1
35a		M60A00013	D10417	PULLEY COND.DP.212X4 GOLE SPB MOZZO LAT	nr.	1
35b		M60A00014	D10418	PULLEY COND.DP.250X4 GOLE SPB MOZZO LAT	nr.	1
36		M75A00029	D10419	BUSHING CONICA 75-50 D.33 (3020)	nr.	1
37		MF0A00014	C00913	"GRAIN 5/8""X1""1/4 (BUSSOLA CON.3020)"	nr.	1
38a		M55A00015	C31529	"BELT ""XPB""1250 DENTEL (TL30-140/160)"	nr.	1
38b		M55A00016	C31530	"BELT ""XPB""1400 DENTEL (TL30-180/200)"	nr.	1
39b		M60A00019	R60113	PULLEY COND. 190X4 TL30-180/200 MOZZO CENTR.	nr.	1
39a		M60A00025	R60478	PULLEY COND. 150X4 TL-140/160 MOZZO CENTR	nr.	1
40a		M75A00072	R60144	BUSHING CONICA (2517) 65-45 D=35	nr.	1
40b		M75A00074	R60157	BUSHING CONICA (2517) 65-45 D=40	nr.	1
41		MF0A00013	C00912	"GRAIN 1/2""X1"" (BUSSOLA CON.2517)"	nr.	1
42		M80A00120	C00132	SCREW TE 88 PG FT M10X30 ZINC UNI 5739	nr.	1
43		M90A00007	C03004	WASHER PIANA D.10,5 DIN125-A ZINC.	nr.	1
44		M85A00077	C02604	NUT AUTOBLOC ALTO 8 M10 H=11.5 UNI 7473	nr.	1
45a		C15A00853	R60114	PROTECTION LAT COFANO TL30-140/160	nr.	1
45b		C15A00854	R60115	PROTECTION LAT COFANO TL30-180/200	nr.	1
46		M80A00121	C00133	SCREW TE 88 PG FT M10X35 ZINC UNI 5739	nr.	1
47		M90A00007	C03004	WASHER PIANA D.10,5 DIN125-A ZINC.	nr.	1
48		M85A00077	C02604	NUT AUTOBLOC ALTO 8 M10 H=11.5 UNI 7473	nr.	1
49		G10A00051	D08998	PROTECTION OVALE 210X275XH150 FORATA	nr.	1
50		M80A00116	C00128	SCREW TE 88 PG FT M10X16 ZINC UNI 5739	nr.	1
51		M90A00007	C03004	WASHER PIANA D.10,5 DIN125-A ZINC.	nr.	1
52a		G05A00056	R60104	PROTECTION POSTERIORE GOMMA TL30-140 130X6	nr.	1
52b		G05A00057	R60105	PROTECTION POSTERIORE GOMMA TL30-160 130X6	nr.	1
52c		G05A00058	R60106	PROTECTION POSTERIORE GOMMA TL30-180 130X6	nr.	1
52d		G05A00059	R60107	PROTECTION POSTERIORE GOMMA TL30-200 130X6	nr.	1
53a		C15A00916	R60514	METAL STRAP FISS. PROTEZ POST.TL30-140 25X4X1390	nr.	1
53b		C15A00917	R60515	METAL STRAP FISS. PROTEZ POST.TL30-160 25X4X1590	nr.	1

53c	 C15A00918	R60516	METAL STRAP FISS. PROTEZ POST.TL30-180 25X4X1790	nr.	1
53d	 C15A00919	R60517	METAL STRAP FISS. PROTEZ POST.TL30-200 25X4X1990	nr.	1
54	 M80A00113	C00124	SCREW TE 88 PG FT M8X35 ZINC UNI 5739	nr.	1
55	 M90A00005	C03003	WASHER PIANA D.8,4 DIN125-A ZINC.	nr.	1
56	 M85A00075	C02603	NUT AUTOBLOC ALTO 8 M8 H=10.6 UNI 7473	nr.	1
57	 M79A00086	M08543	KIT SFIATO GRUPPO R240 (TL31/33) L= 365	nr.	1
58a	 C10A03451	R60526	PLATE DI PROT.120X4X182 1 SCANT	nr.	1
58b	 C10A03452	R60527	PLATE DI PROT. 140X4X182 1 SCANT	nr.	1

ALPEGO

Rotor and holder

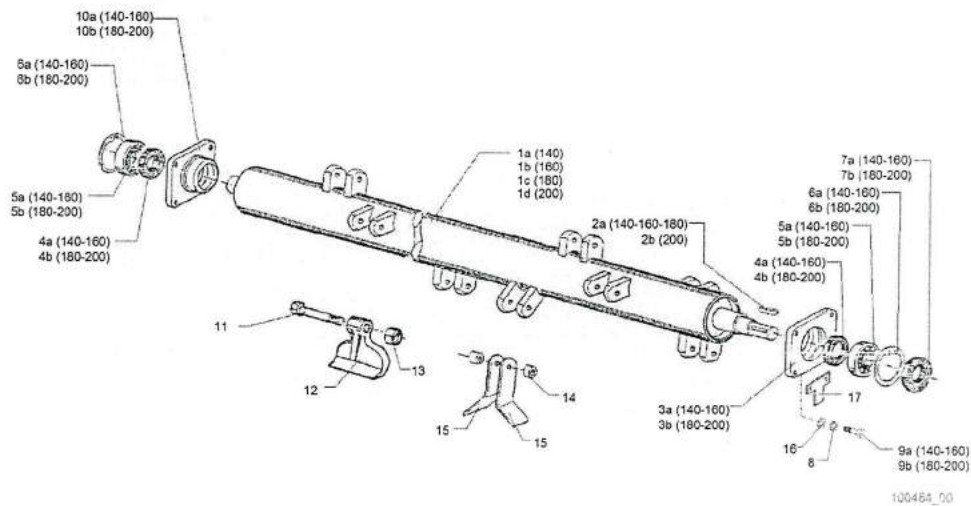

		New Code (9 digits)	Old Code	Description	Unit of measure	Qty
1a		M10A00082	R60121	ROTOR COMPLETO DI MAZZE TR20 / TL30 140	nr.	1
1b		M10A00084	R60122	ROTOR COMPLETO DI MAZZE TR20 / TL30 160	nr.	1
1c		M10A00086	R60123	ROTOR COMPLETO DI MAZZE TL30-180	nr.	1
1d		M10A00088	R60124	ROTOR COMPLETO DI MAZZE TL30-200	nr.	1
2a		MC0A00003	C04906	TONGUE 10X8X50 UNI 6604	nr.	1
2b		MC0A00015	C04918	TONGUE 12X8X50 UNI 6604A	nr.	1
3a		M35A00062	R60116	SUPPORT ROTOR SIN. TL30-140/160 TR2	nr.	1
3b		M35A00065	R60120	SUPPORT ROTORE DS/SN TR25/TL30-180/200*	nr.	1
4a		H00A00057	C10142	SEALING RING BASL D.50X80X10	nr.	1
4b		H00A00065	C10152	SEALING RING BASL D.55X90X10	nr.	1
5a		M20A00105	C21863	BEARING OR.SFE 1308 ETN9 40X90X23	nr.	1
5b		M20A00106	C21865	BEARING OR.SFE 1309 ETN9 45X100X25	nr.	1
6a		MA0A00012	C04037	SEGER FORO D.90 UNI 7437	nr.	1

6b	 MA0A00014	C04039	SEEGER FORO D.100 UNI 7437	nr.	1
7a	 H00A00048	C10122	SEALING RING BASL D.40X90X10	nr.	1
7b	 H00A00052	C10135	SEALING RING BASL D.45X100X10	nr.	1
8	 M90A00037	C03107	WASHER GROWER D.16 DIN 127 ZINCATA	nr.	1
9a	 M80A00147	C00161	SCREW TE 88 PG M16X30 ZINC UNI 5739	nr.	1
9b	 M80A00148	C00162	SCREW TE 88 PG FT M16X35 ZINC UNI 5739	nr.	1
10a	 M35A00064	R60118	SUPPORT ROTOR DES. TL30-140/160 TR20***	nr.	1
10b	 M35A00065	R60120	SUPPORT ROTORE DS/SN TR25/TL30-180/200*	nr.	1
11	 M80A00340	C00846	SCREW TE 12.9 PG M16X92 FIL22 UNI 5737	nr.	1
12	 MK0A00211	P40060	HAMMER TRINCIA FORO=16.5 LARG=140 R=95	nr.	1
13	 M85A00080	C02607	NUT AUTOBLOC ALTO 8 M16 H=18 UNI 7473	nr.	1
14	 C15A00801	P40088	SPACER FORO 19 H10.5 D35 (XCOLT.)	nr.	1
15	 MK0A00220	P40086	BLADE UNIVERS. TRISAR D16.5 L70 R=95	nr.	1
16	 M90A00010	C03007	WASHER PIANA D.17 DIN125-A ZINC.	nr.	1
17	 C10A02363	D09297	PROTECTION SUPPORTO TL- TR25 sp5mm	nr.	1

ALPEGO

Rear roller

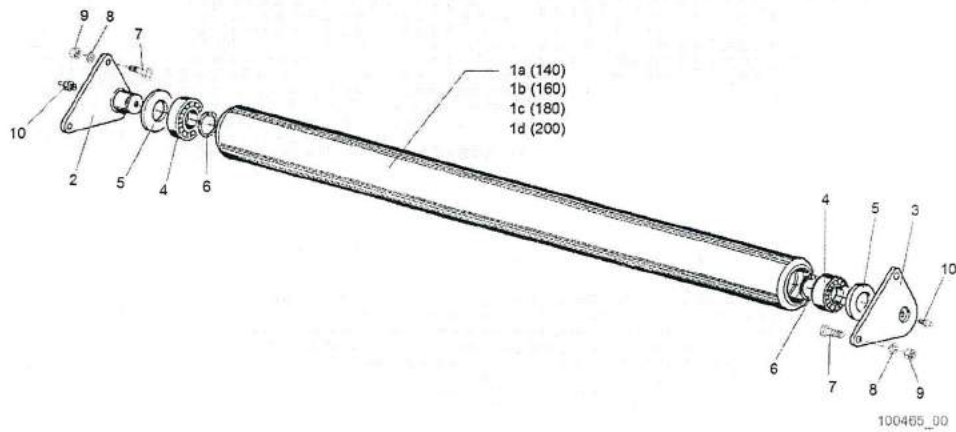







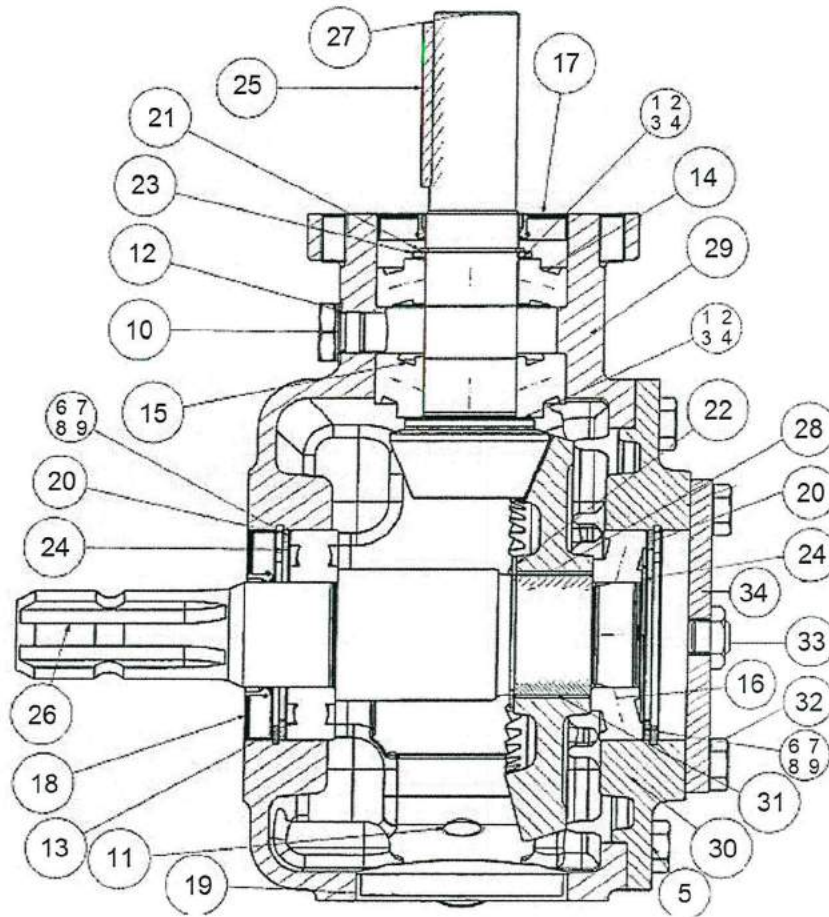
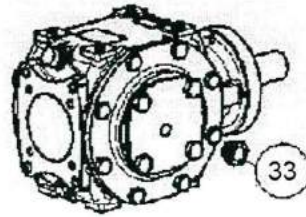



	 New Code (9 digits)	 Old Code	Description	Unit of measure	Qty
1a	 C20A02488	 R60125	ROLLER POST.TR25/TL30-140***	nr.	1
1b	 C20A02489	 R60126	ROLLER POST.TR25/TL30-160***	nr.	1
1c	 C20A02490	 R60127	ROLLER POST.TR25/TL30-180***	nr.	1
1d	 C20A02491	 R60128	ROLLER POST.TR25/TL30-200***	nr.	1
2	 C20A02492	 R60129	SUPPORT RULLO DESTRO TL30	nr.	1
3	 C20A02493	 R60130	SUPPORT RULLO SINISTRO TL30	nr.	1
4	 M20A00049	 C21229	BEARING 6310 Z C3 (CL- B) 50X110X27	nr.	1
5	 M35A00066	 R60131	WASHER PARAPOLVERE RULLO POST. TR20	nr.	1
6	 MA0A00041	 C04142	SEGER ALBERO D.50 UNI 7435	nr.	1
7	 M80A00149	 C00163	SCREW TE 88 PG FT M16X40 ZINC UNI 5739	nr.	1
8	 M90A00010	 C03007	WASHER PIANA D.17 DIN125-A ZINC.	nr.	1
9	 M85A00080	 C02607	NUT AUTOBLOC ALTO 8 M16 H=18 UNI 7473	nr.	1
10	 MJ5A00003	 C41103	GREASE NIPPLE M8X1.25 DRITTO ESAGONO 11.	nr.	1



Overgear



100511_01

	 New Code (9 digits)	Old Code	Description	Unit of measure	Qty
1	 MA5A00053	C04255	THICKNESS REG. 35X45X0,20	nr.	1
2	 MA5A00054	C04256	THICKNESS REG. 35X45X0,25	nr.	1
3	 MA5A00055	C04257	THICKNESS REG. 35X45X0,35	nr.	1
4	 MA5A00056	C04258	THICKNESS REG. 35X45X0,50	nr.	1
5	 M80A00118	C00131	SCREW TE 88 PG FT M10X25 ZINC UNI 5739	nr.	1
6	 MA5A00025	C04225	THICKNESS REG. 65,3X79,7X0,2	nr.	1
7	 MA5A00026	C04226	THICKNESS REG. 65,3X79,7X0,25	nr.	1
8	 MA5A00027	C04227	THICKNESS REG. 65,3X79,7X0,3	nr.	1
9	 MA5A00028	C04228	THICKNESS REG. 65,3X79,7X0,5	nr.	1
10	 H45A00016	C41225	PLUG M16X1,5 (32.A)	nr.	1
11	 H65A00002	C41230	PLUG SFIATO M16X1,5 (30.A) LABIRINTO	nr.	1
12	 H35A00042	C40382	WASHER RAME 3/8 D.17	nr.	1
13	 M20A00028	C21120	BEARING 6208 40x80x18	nr.	1







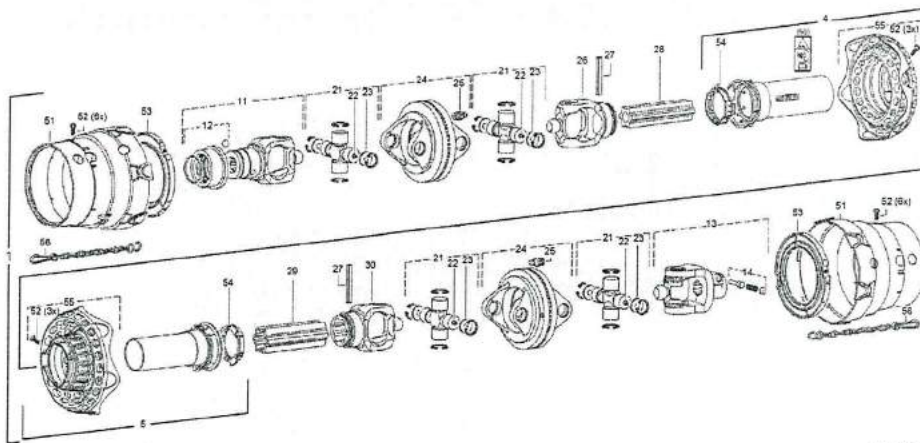

















14	 M20A00059	C21407	BEARING 30207 35X72X18,25 J2	nr.	1
15	 M20A00070	C21507	BEARING 32207 35X72X24,25	nr.	1
16	 M20A00060	C21408	BEARING 30208 40X80X19,75	nr.	1
17	 H00A00044	C10118	SEALING RING BASL D.35X72X10	nr.	1
18	 H00A00101	C10123	SEALING RING BASL D.40X80X10	nr.	1
19	 H00A00087	C10321	PLASTIC GUARD D.80X10	nr.	1
20	 MA0A00010	C04035	SEEGER FORO D.80 UNI 7437	nr.	1
21	 MA0A00036	C04138	SEEGER ALBERO D.35 UNI 7435	nr.	1
22	 MA0A00043	C04143	SEEGER ALBERO d.48 UNI 7435	nr.	1
23	 MA5A00057	C04259	THICKNESS REG. 35.2X45X2	nr.	1
24	 MA5A00073	C04274	FIFTH WHEEL REG. 65X79X2	nr.	1
25	 MC0A00004	C04907	TONGUE 10X8X60 UNI 6604	nr.	1
26	 M45A00120	R90022	"SHAFT P.T.O 1""3/8 RUOTA LIBERA OPPOSTA TL32"	nr.	1
27	 M40A00139	R90016	PINION CONICO Z=12 M=4,23 TL30-TL32	nr.	1
28	 M40A00141	R90023	CROWN CONICA RUOTA LIB.OPP Z=37 M=4,23	nr.	1
29	 C15A01016	R90018	BOX RIDUTTORE R240 TL30-TL32	nr.	1
30	 M35A00082	R90019	FLANGE P.T.O RIDUTTORE R240 TL30-TL32	nr.	1
31	 M75A00143	R90020	KIT NOTTOLINO L=28 + MOLLA RUOTA LIBERA TL30-TL32	nr.	1
32	 M80A00117	C00130	SCREW TE 88 PG FT M10X20 ZINC UNI 5739	nr.	1
33	 H60A00004	C41315	LIGHT LIVELLO OLIO 16X1,5 (38A)	nr.	1
34	 C15A01017	R90024	LID POSTERIORE SCATOLA R240	nr.	1

ALPEGO

PTO shaftM06960W



100000_00

			New Code (9 digits)	Old Code	Description	Unit of measure	Qty
1			M70A00072	M06960W	"UNIVERSAL JOINT WWZ2480-SD25/1 1510 S4LGA/S5 1"3/8Z=6-1"3/8Z=6"	nr.	1
4			G10A00106	R70157	PROTECTION CARD. EST. SCH25/1 A1500 (85.21.0)	nr.	1
5			G10A00107	R70158	PROTECTION CARD. INT. SCH25/1 J1500 (85209)	nr.	1
11			M72A00102	R70159	"FORK ASG2480- 1"3/8 (6) COLLAR"	nr.	1
12			M75A00107	R70160	"CONNECTION RAPIDO CL200 1"3/8 (AGRASET 172)"	nr.	1
13			M72A00103	R70161	"FORK AG2480- 1"3/8 z=6 PULS."	nr.	1
14			MF0A00066	R70010	BUTTON WALTERSCHEID 339107	nr.	1
21			M71A00013	R70162	CRUISE COMPL 2480 WALT. (35.06.131)	nr.	1
22			MJ5A00013	R70163	GREASE NIPPLE DIN71412 AM 6 (63.11.01)	nr.	1
23			M90A00072	R70164	WASHER D31.95x2 (36.06.70)	nr.	1
24			M72A00104	R70165	FORK DOPPIA DOPG2480 (35.41.05)	nr.	1
25			MJ5A00014	R70166	GREASE NIPPLE DIN71412 AM 8.2X1 (63.12.05)	nr.	1

26	 M72A00105	R70167	FORK TUBO RG2580-S4 (35.13.109)	nr.	1
27	 MB0A00036	C04548	SOCKET ELASTICA D.10X80	nr.	1
28	 M73A00066	R70168	TUBE S4LGA L=1180 (75.43.91)	nr.	1
29	 M73A00067	R70169	TUBE S5 L=1160 (75.45.00)	nr.	1
30	 M72A00106	R70170	FORK TUBO RG2480-S5 (35.14.174)	nr.	1
51	 G00A00055	R70171	CONE DI PROTEZIONE SD25-2480 (85.01.02)	nr.	1
52	 M80A00387	R70172	SCREW AUTOFIL.D.3.5x9.5	nr.	1
53	 C15A00947	R70173	RING FISS.CONO SD25-2480 (82.83.14)	nr.	1
54	 G00A00053	R70076	BUSH PLASTICA PROT. W2500 087276	nr.	1
55	 G10A00108	R70174	PROTECTION FLESSIB. CONO SD25-WW (85.01.12)	nr.	1
56	 MH0A00023	R70175	CHAIN DI SICUREZZA L=600 (82.36.08)	nr.	1

ALPEGO

PTO shaftM06960

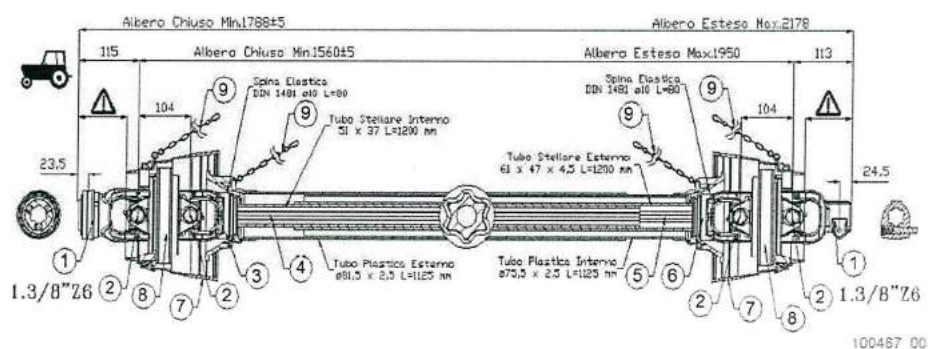

	New Code (9 digits)	Old Code	Description	Unit of measure	Qty
2	M71A00005	R50115	CRUISE OMOCINETICA D.32x76-D.27x98	nr.	1
3	M72A00061	R50116	FORK OMOCINETICA STELLARE INT. V55	nr.	1
4	M73A00033	R50060	TUBE STELLARE 51X37X1200 TEMPRATO	nr.	1
5	M73A00040	R50076	TUBE STELLARE 61X47X4,5X1200 BONIFICATO	nr.	1
1	M72A00060	R50114	"FORK W57 1"3/8 z6 COLLAR RAPID OMOC"	nr.	1
6	M72A00062	R50117	FORK OMOCINETICA STELLARE EST. V57	nr.	1
7	G10A00086	R50077	PROTECTION COMPL.CARDANO BENZI (M06960) DOPPIO OMOCIN.	nr.	1
8	M72A00063	R50118	FORK DOPPIA GRANDANGOLO W50-W57	nr.	1
9	MH0A00022	R50119	CHAIN PROTEZ.CARDANO L=550	nr.	1