

Technik-Plus

Sämaschinen e.U.

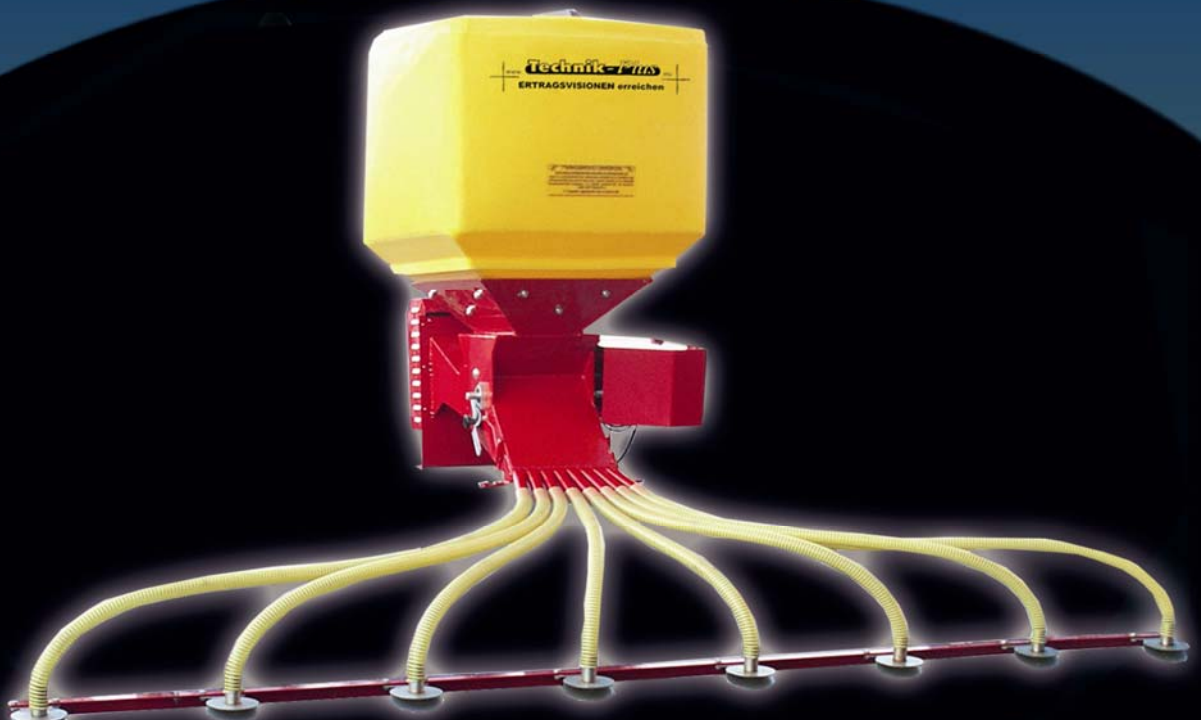

TAKE A LOOK!

***The easy way to best harvest
and great success!***



FLEXIBLE – ECONOMICAL – PRODUCTIVE

The easy way to a professional Agriculture!

An effective catch crop, before a main crop, can reduce weed and can bring a high amount of fertilizer and organic material for bio organisms into the soil. A catch crop in autumn (after slurry or manure) can hold most of the nutrients in the soil, until the next crop in spring is growing. An excellent catch crop of sugar beet is oil radish. It reduces nematodes and offers the best soil conditions for sugar beet. We experienced a high harvest amount with this method, even if the use of mineral fertilizer is reduced and if soil cultivation is minimized.

Best quality, at efficient cost and most reliable technic!



Power-Turbo: FRONT/REAR MOUNTING



High capacity seeder for spreading fertilizer! Seeding with harrows, fertilizer-spreading on no crop culture. Working widths up to 24 m or 40 rows offer new performance parameter.

The most economical concept for a professional agriculture!

TOWER-DISTRIBUTORS

When space is limited (f.ex. with folded implements), and when hopper requires to be fitted on a lower position. It is possible to operate with 1 to 5 tower-distributors, to bring the seeds to the desired positions.

**PRODUCTIVE – FLEXIBLE -
ECONOMICAL**

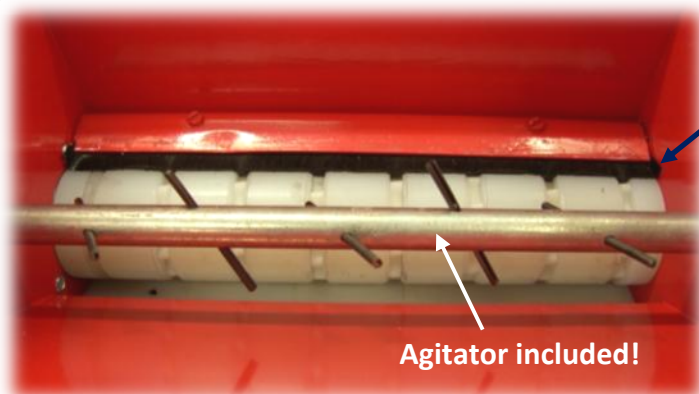

Agitator included!

AUTOMATICALLY CLEANING

Especially for the seeding of rapeseed or seeds with powder production, we offer optional a **special cleaning brush**. This brush secures a clean seed roll and guaranties a constant flow of the seed.

DOSAGE

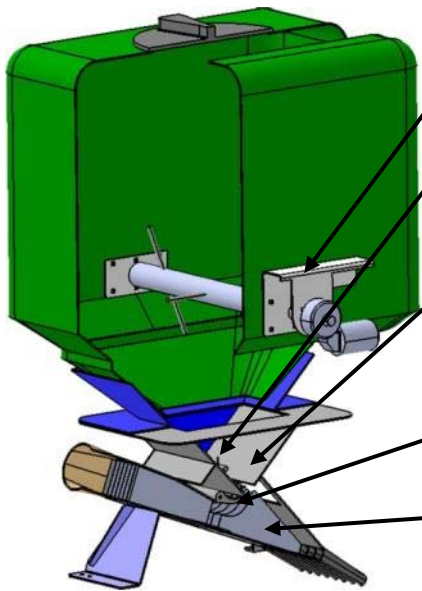

Hopper agitator (optional – additional charge)

To avoid blockages in the hopper;

Agitator

Supports a continuous seed flow and avoids blockages at the seed roll;

Seed roll

We offer different seed rolls: standard seed roll (mustard, rye, oilradish, etc.), grass seed roll (for big amounts/seeds) or seed roll for small amounts (or small seeds);

Flaps

The flaps carry the seed to the lamella;

Lamella

Is responsible for quantitative equal output of the seeds;

AIR SUPPLY

1. Electric driven fan (“Quattro-Blower-Techniques”),
2. Hydraulic driven fan - mounted (310mm or 380mm),
3. Hydraulic driven fan – extern (395mm or 540mm),
4. Driven from tractor PTO drive or hydraulic;

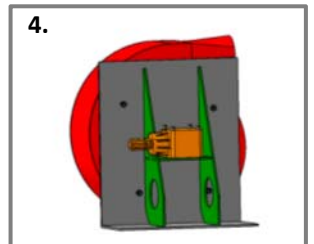
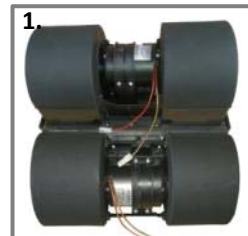

DISTRIBUTION

1. **Towers** (on demand with 9 – 35 outlet tubes and transparent cover for visible seed flow)
2. **Spreader plates** (for horizontal or vertical mounting)
3. **Lineal technique** (seeding in rows – for disc harrows)



HOPPER

- with litre-indication and sealed cover
- transparent



Optional:
Fill in filter
(stainless steel)



ADDITIONAL EQUIPMENT

SEED ROLLS:



Standard seed roll



Grass seed roll



Seed roll for small amounts
(5mm, 10mm, 15mm)

CONTROL UNIT:

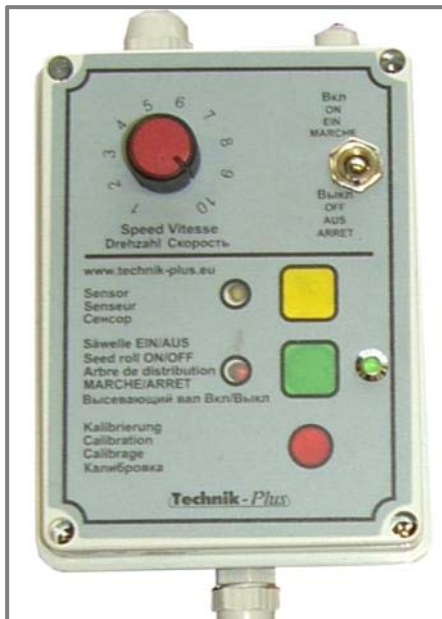

1. PROFI-Control Unit (Standard):

- ◆ ON/OFF;
- ◆ Stepless adjustment of speed (of seed roll-motor);
- ◆ Blower ON/OFF;
- ◆ Control light for blower;
- ◆ Calibration function;

OPTIONAL EQUIPMENT:

- ◆ Seed shaft control sensor,
- ◆ ON/OFF-sensor to Profi-control-unit;

2. MULTIFUNCTIONAL-Control Unit (optional):

- ◆ Vario speed control unit;
- ◆ Fully automatically;
- ◆ Includes speed-sensor;
- ◆ Includes audio warn alarm;
- ◆ Parameters on digital display:
 - Chosen output amount: **kg/ha**
 - Total spreaded amount: **kg tot**
 - Operated area: **ha**
 - Driven speed : **km/h**



OPTIONAL EQUIPMENT:

- ◆ Low-level sensor for hopper
- ◆ ON/OFF-sensor
- ◆ Signal plug connector cable → → →
(for tractormeter)

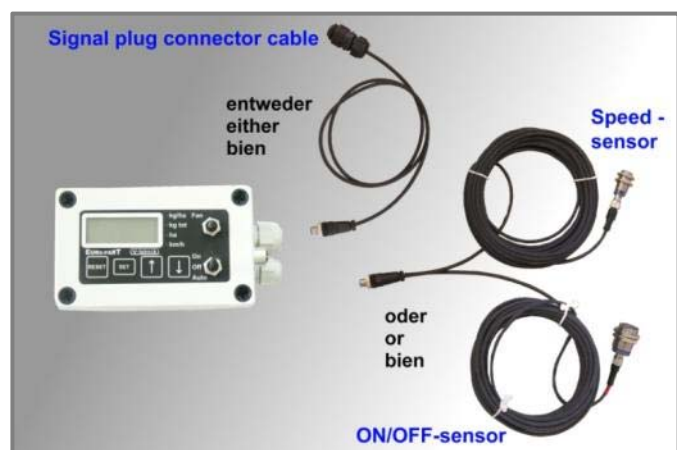

Technik-Plus

SOWING IS OUR JOB! FLEXIBILITY YOUR ADVANTAGE!

**Your seeding job needs to be done in the fastest time?
At good effect for a quick growth, even in dry weather periods?
With most economical cost?**

**Let's discuss how to realise a reliable harvest, even
in very changeable weather conditions!**

**The possibilities are unlimited!
Something must be done right now!**



PROFESSIONAL

- ◆ Powder coated frame with 50x50 square tube
- ◆ 12V drive from tractor battery
- ◆ Stainless steel spreader plate and feeder
- ◆ Control unit in the cab (ON/OFF, feeder open/close, working width adjustment)
- ◆ 90lit. (standard)/105lit. hopper with easy emptying
- ◆ Equal output of seed adjustable
- ◆ Feeder motor 240N, spreader plate motor 240W
- ◆ Agitator

OPTIONAL: 60lit. or 130lit. hopper



Equipment same as Professional, **ADDITIONAL:**

- ◆ Fuse for feeder motor and spreader plate motor (in control unit)
- ◆ **Power-Start-Automatic:** If you turn the motor to ON, it starts full speed rotating and turns back to the adjusted speed after some seconds (=adjustable);



CONVENIENCE



SUPER XXXL

Equipment same as Professional, **ADDITIONAL:**

- ◆ Fuse for feeder motor and spreader plate motor (in control unit)
- ◆ Adjustable output amount (%) from cab
- ◆ With easy adjustment for equal output
- ◆ Speed shown digitally on control unit
- ◆ Power-Start-Automatic

OPTIONAL: ON/OFF sensor



ÖKO-TURBO

For spreading granulate, micro fertilizer, small seed, etc.

- ◆ 12V drive from tractor battery
- ◆ **selective 1, 2, 3, 4- or 5** (=standard) **outlet tubes**
- ◆ 90lit. (standard)/105lit. hopper
- ◆ Control unit in the cab (ON/OFF, amount adjustment)
- ◆ Agitator
- ◆ Standard seed roll

OPTIONAL:

- grass seed roll or seed roll for small amounts
- 60lit. or 130lit. hopper
- Multifunctional control unit →



SILO-JET

- ◆ Electric 12V membran pump
- ◆ 2m suction hose with suction filter
- ◆ 1,2m pressure hose with nozzle holder, filter, nozzle element
- ◆ 1 x INOX-pressure adjustment valve
- ◆ 1 x –Switch ON/OFF
- ◆ 50lit. hopper (standard)



50lit.hopper



OPTIONAL:

- 150lit. or 200lit. hopper
- Second nozzle holder with filter and nozzle elements



TECHNIK-PLUS SÄMASCHINEN e.U., www.TECHNIK-PLUS.eu

INDUSTRIEPARKSTRASSE 6 -8, 8480 MURECK (AUSTRIA)

PHONE: +43 3472 21120, FAX: +43 3472 21123, TECHNIK-PLUS@TECHNIK-PLUS.EU