

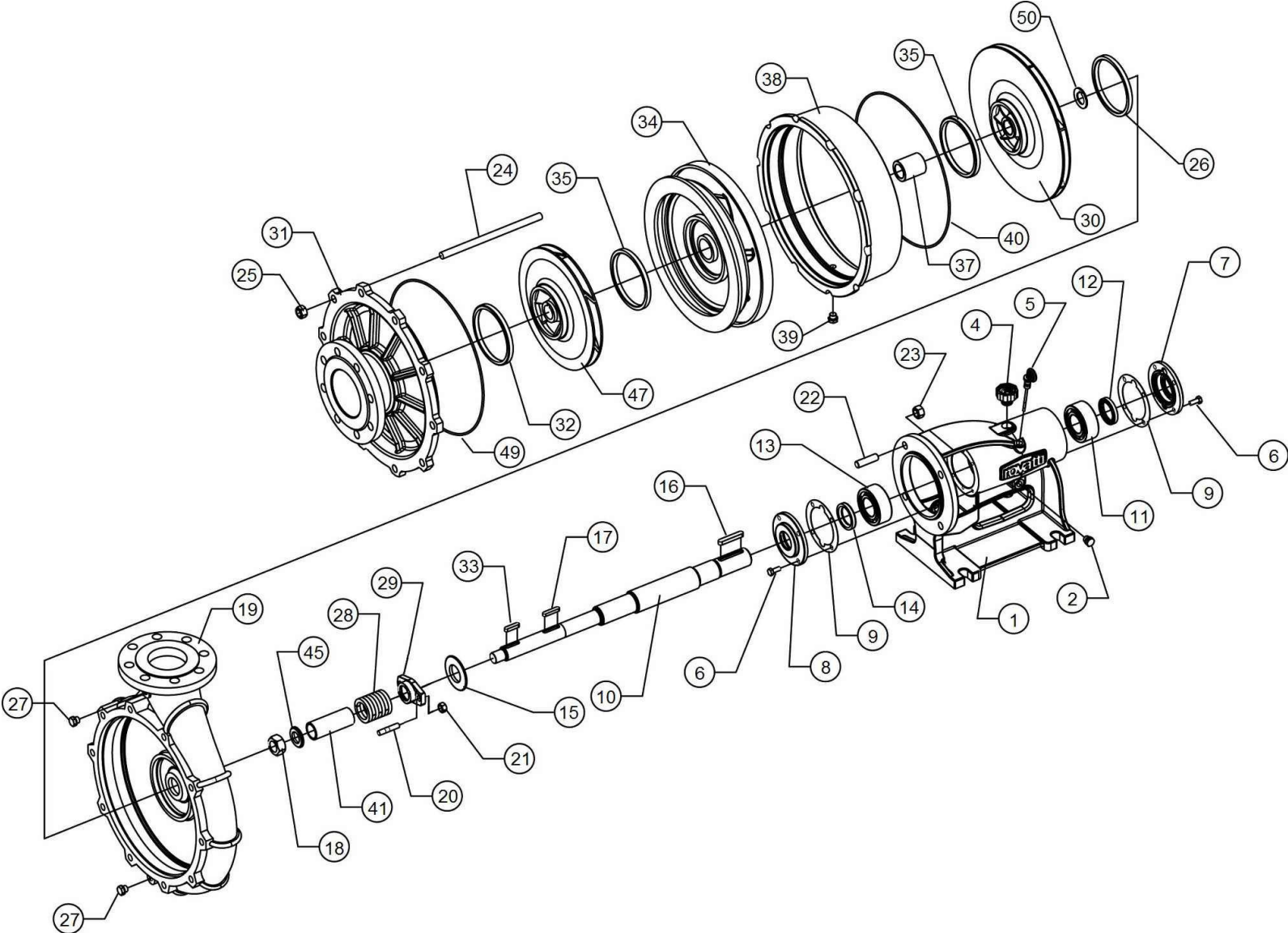











S2K65/2E







S2K65/2E

		Code	Description	Qty
1		203331A/A	Bearing support	1
2		204470B	Magnetic plug	1
4		203370P	Breather plug	1
5		203325P	Oil dipstick	1
6		3VTCEI020	Screw	6
7		203334A/A	Cover	1
8		203334A/A	Cover	1
9		203340F	Gasket	2
10		209532H	Shaft	1
11		3CU016	Ball bearing	1
12		3AT005	Seal ring	1
13		3CU016	Ball bearing	1
14		3AT005	Seal ring	1
15		3AP003	Seal ring	1
16		3LI023	Key	1
17		3LI012	Key	1
18		217274N	Self-locking nut	1
19		203977A/A	Pump body	1
20		3VP005T	Stud bolt	2
21		3DEA010T	Nut	2

S2K65/2E

		Code	Description	Qty
22		3VP016	Stud bolt	4
23		3DEA012Z	Nut	4
24		3VP022	Tie rod	8
25		3DEA012Z	Nut	8
26		203990A	Wear ring	1
27		3NO019	Plug	2
28		214113F	Stuffing-box ring	6
29		201007C	Stuffing-box flange	1
30		203979A00	Impeller	1
31		203978A/A	Suction cover	1
32		203990A	Wear ring	1
33		3LI011	Key	1
34		203981A/A	Diffuser	1
35		203990A	Wear ring	2
37		203986T	Spacer	1
38		203952A	Diffuser shell	1
39		3NO019	Plug	1
40		3OR069	O-Ring	1
41		209011Q	Bush	1
45		206715D	Washer	1

S2K65/2E

		Code	Description	Qty
47		203980A00	Impeller	1
49		218271F	Gasket	1
50		209538I	Spacer	1