

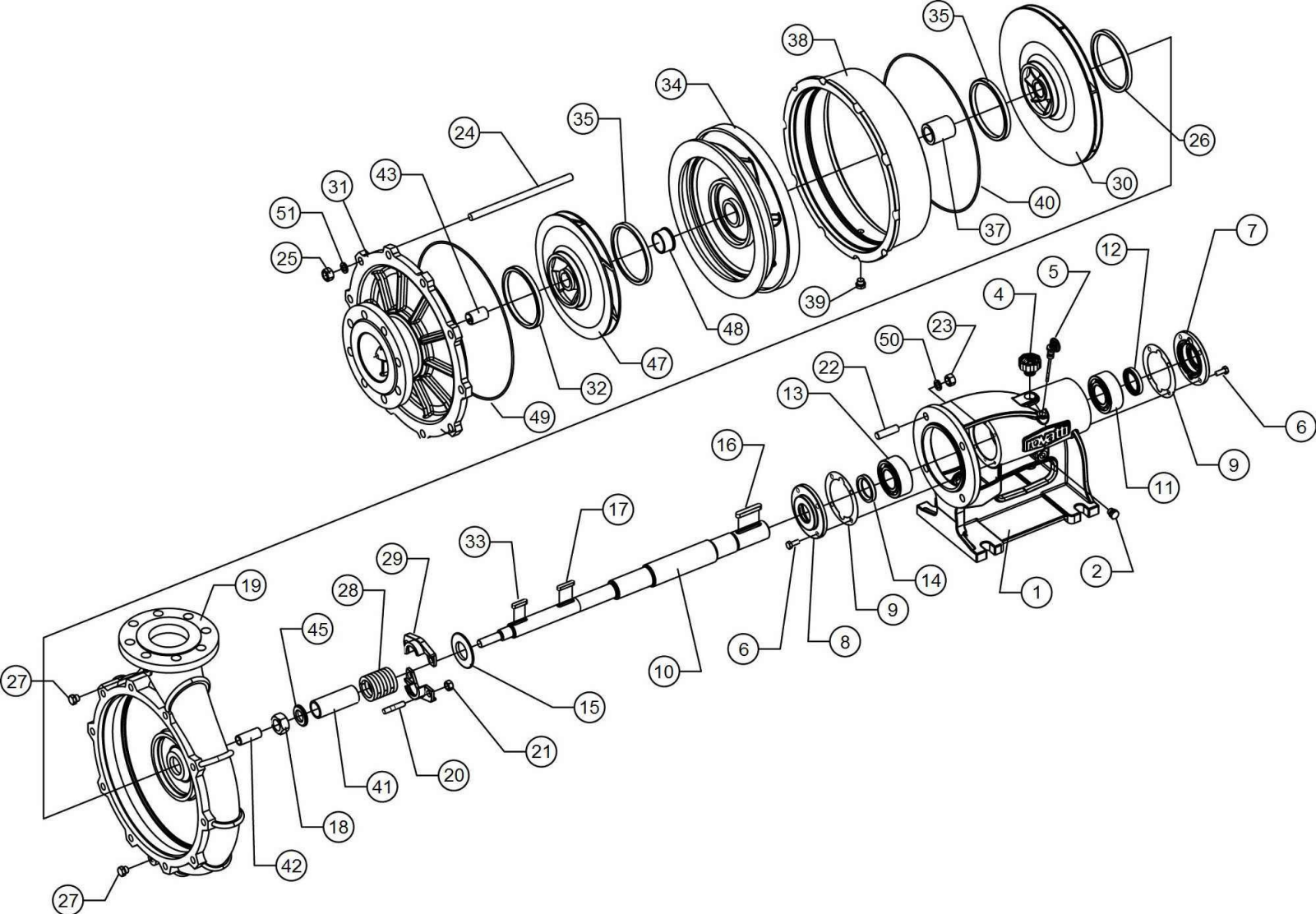









S3K100H/2E



S3K100H/2E

		Code	Description	Qty
1		203346A	Bearing support	1
2		204470B	Magnetic plug	1
4		203370P	Breather plug	1
5		203405P	Oil dipstick	1
6		3VTE002	Screw	8
7		203903A/A	Cover	1
8		203903A/A	Cover	1
9		203355F	Gasket	2
10		214277H	Shaft	1
11		3CU123	Ball bearing	1
12		3AT054	Seal ring	1
13		3CU123	Ball bearing	1
14		3AT054	Seal ring	1
15		3AP005	Seal ring	1
16		3LI015	Key	1
17		3LI067	Key	1
18		216377N	Self-locking nut	1
19		213973A/A	Pump body	1
20		3VP005T	Stud bolt	2
21		3DEB010T	Nut	2

S3K100H/2E

		Code	Description	Qty
22		3VP021	Stud bolt	4
23		3DEA014Z	Nut	4
24		3VP143	Tie rod	10
25		3DEA014Z	Nut	10
26		213710I	Wear ring	1
27		3NO019	Plug	2
28		215054F	Stuffing-box ring	7
29		214896T/A	Twiner stuffing-box flange	1
30		203689AF00	Impeller	1
31		203652A/1A	Suction cover	1
32		213710I	Wear ring	1
33		3LI012	Key	1
34		212623AF/A	Diffuser	1
35		213710I	Wear ring	2
37		203694T	Spacer	1
38		203685A/A	Diffuser shell	1
39		3NO019	Plug	1
40		3OR035	O-Ring	1
41		213952Q	Bush	1
42		209486Q	Bush	1

S3K100H/2E

🗨	🛒	Code	Description	Qty
43	🛒	206979C	Bearing	1
45	🛒	206714D	Washer	1
47	🛒	203690AF00	Impeller	1
48	🛒	212622C	Bush	1
49	🛒	216376F	Gasket	1
50	🛒	3RE014Z	Washer	4
51	🛒	3RE014Z	Washer	10