

# MONOSEM

FEP - 2018  
Réf.10640202

COMPAGNIE COMMERCIALE RIBOULEAU

## NOTICE SEMOIRS FEP FEP PLANTER MANUAL



NOTICE  
D'UTILISATION



USERS  
MANUAL



Manual de Montaje,  
Puesta a punto,  
Conservación



Notizia di Montaggio  
Regolazione,  
Manutenzione





Cette notice est à lire attentivement avant montage et utilisation, elle est à conserver soigneusement. Pour plus d'informations, ou en cas de réclamation, vous pouvez appeler l'usine RIBOULEAU MONOSEM, numéro de téléphone en dernière page.

L'identification et l'année de fabrication de votre semoir se trouvent sur la boîte de distances.

Par souci d'amélioration continue de notre production, nous nous réservons le droit de modifier sans préavis nos matériels qui de ce fait, pourront par certains détails être différents de ceux décrits sur cette notice.

### NOTICE ORIGINALE

This manual should be read carefully before assembly and operation. It should be kept in a safe place. For further information or in the event of claims, please call the RIBOULEAU MONOSEM factory. You will find the telephone number on the last page of this manual.

The identification and year of manufacture of your planter are on the central gear box.

With the aim of continuously improving our products, we reserve the right to modify our equipment without notice. As a result, some elements may differ from those described in these instructions.

### ORIGINAL INSTRUCTIONS

Lea atentamente este folleto de instrucciones antes de montar y usar el equipo. Consérvelo cuidadosamente. Para más información, o en caso de reclamación, póngase en contacto con la planta de RIBOULEAU MONOSEM, cuyo número de teléfono aparece en la última página.

La identificación y el año de fabricación de la sembradora figuran en la caja de distancias central.

Al objeto de mejorar continuamente nuestra producción, nos reservamos el derecho de modificar sin previo aviso el material que en ciertos detalles pudiese ser diferente al descrito en estas instrucciones.

### MANUAL ORIGINAL

Le seguenti istruzioni devono essere lette con attenzione prima del montaggio e dell'uso, e devono essere conservate con cura. Per maggiori informazioni, o in caso di reclami, potete contattare l'azienda RIBOULEAU MONOSEM, il cui numero di telefono è all'ultima pagina.

L'identificazione e l'anno di fabbricazione della sua seminatrice si trovano sulla scatola delle distanze.

Al fine di migliorare continuamente la nostra produzione, ci riserviamo il diritto di modificare senza preavviso i nostri materiali; per questo motivo alcuni particolari potranno differire da quanto descritto in questa specifica.

### ISTRUZIONI ORIGINALI

Vous venez d'acquérir un appareil fiable mais **ATTENTION** à son utilisation !...

#### 2 PRÉCAUTIONS POUR RÉUSSIR VOS SEMIS :

- Choisissez une vitesse de travail raisonnable adaptée aux conditions et à la régularité désirée.
- Assurez-vous dès la mise en route puis de temps en temps de la DISTRIBUTION, de l'ENTERRAGE, de la DENSITÉ.

You have just purchased a reliable machine but **BE CAREFUL** using it !...

#### 2 PRECAUTIONS FOR SUCCESSFUL PLANTING :

- Choose a reasonable working speed adapted to the field conditions and desired accuracy.
- Check proper working of the seed metering, speed PLACEMENT, SPACING and DENSITY before planting and from time to time during planting.

VD, acaba de comprar una máquina fiable, pero haga **atención** a su uso.

#### 2 PRECAUCIONES PARA CONSEGUIR SU SIEMBRA :

- Escoja una velocidad de trabajo razonable adaptada a las circunstancias y a la regularidad deseada.
- Desde la puesta en marcha y de vez en cuando, compruebe la distribución, la densidad y el enterramiento.

Avete appena acquisitato una seminatrice affidabile, ma **ATTENZIONE** al suo impiego !...

#### 2 PRECAUZIONI PER LA RIUSCITA DELLE VOSTRE SEMINE :

- Scegliete una velocità di lavoro adatta alle condizioni e alla regolarità desiderata.
- Controllate la DISTRIBUTIONE, l'INTERRAMENTO e la DENSITA' al momento della messa in campo e poi di tanto in tanto.

## SOMMAIRE

1 - Prescriptions de sécurité	2
2 - Introduction	11
3 - Description	15
4 - Montage et réglage courroie alternateur	17
5 - Montage et entretien de la batterie	19
6 - Montage et réglage des capteurs «fin de course»	21
7 - Vitesse de rotation du disque de distribution	26
8 - Description et utilisation de la console	29
9 - Stockage du matériel	102
10 - Pièces de rechange	105

## CONTENTS

1 - Safety regulations	4
2 - Introduction	11
3 - Description	15
4 - Alternator belt assembly and setting	17
5 - Battery assembly and maintenance	19
6 - "End of travel" sensor assembly and setting	21
7 - Metering disk rotation speed	26
8 - Description and use of the console	29
9 - Storing equipment	102
10 - Spare parts	105

## ÍNDICE

1 - Prescripciones de seguridad	6
2 - Introducción	11
3 - Descripción	15
4 - Montaje y ajuste de la correa del alternador	17
5 - Montaje y mantenimiento de la batería	19
6 - Montaje y ajuste de los captadores de «fin de carrera»	21
7 - Velocidad de giro del disco de distribución	26
8 - Descripción y uso de la consola	29
9 - Almacenaje del material	102
10 - Piezas de repuesto	105

## SOMMARIO

1 - Prescrizioni di sicurezza	8
2 - Introduzione	11
3 - Descrizione	15
4 - Montaggio e regolazione cinghia alternatore	17
5 - Montaggio e manutenzione della batteria	19
6 - Montaggio e regolazione dei sensori di «fine corsa»	21
7 - Velocità di rotazione del disco di distribuzione	26
8 - Descrizione e utilizzo della console	29
9 - Stoccaggio dell'attrezzatura	102
10 - Pezzi di ricambio	105

# 1 - PRESCRIPTIONS DE SÉCURITÉ

La machine ne doit être utilisée, entretenue et réparée que par du personnel formé à cet effet et averti des risques inhérents. Il est impératif de respecter les consignes de sécurité mentionnées sur les autocollants de la machine, de ses accessoires et de la présente notice. Avant tout déplacement sur la voie publique, il est impératif de s'assurer du respect des dispositions du Code de la route en vigueur et de la conformité avec la réglementation en matière de sécurité du travail.

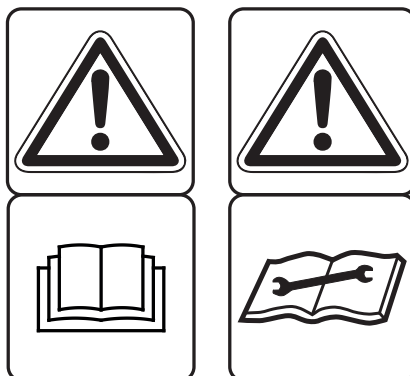

## Attention aux consignes de sécurité :

- **Prise de force** : voir notice jointe.
- **Ne pas travailler sous le semoir.**
- **Rayonneurs** : ne pas stationner sous la charge.
- **Châssis repliables** : ne pas stationner sous la charge.

**ATTENTION** : A cause de son poids important, ne pas laisser le semoir en appui uniquement sur ces 2 roues centrales. Il est interdit d'atteler ou de déteiler appareil replié, celui-ci doit être remis ouvert.

- **Manipulation de produits dangereux** : voir emballage.

## CONSIGNES GÉNÉRALES DE SÉCURITÉ

- 1 - En complément des instructions contenues dans cette notice, respectez la législation relative aux prescriptions de sécurité et de prévention des accidents.
- 2 - Les autocollants apposés sur la machine et ses accessoires fournissent des indications importantes pour une utilisation sans risque. En les respectant, vous assurez votre sécurité.
- 3 - Respectez les prescriptions du Code de la route lors de la circulation sur la voie publique.
- 4 - Familiarisez-vous avec l'utilisation de la machine avant le travail. En cours de travail, il sera trop tard.
- 5 - L'utilisateur doit éviter de porter des vêtements flottants qui risqueraient d'être happés par des éléments en mouvement.
- 6 - Il est recommandé d'utiliser un tracteur équipé d'une cabine ou d'un arceau de sécurité, conformes aux normes en vigueur.
- 7 - Vérifiez que les alentours proches soient dégagés (pas d'enfant).
- 8 - Le transport de personnes et d'animaux en cours de travail et de transport est interdit.
- 9 - Atteler la machine sur les points d'attelage prévus à cet effet, conformément aux normes en vigueur.
- 10 - Les opérations d'attelage et de dételage doivent se faire avec précaution.
- 11 - Lors du dételage, assurez-vous du bon positionnement des béquilles pour une bonne stabilité de la machine.
- 12 - Avant l'attelage de la machine, assurez-vous du bon lestage de l'essieu avant du tracteur.
- 13 - La mise en place des masses doit se faire sur les supports prévus à cet effet, conformément aux prescriptions du constructeur du tracteur et dans le respect des charges maximum par essieu et du poids total autorisé en charge.
- 14 - Mettez en place et contrôlez les équipements réglementaires lors du transport : éclairage, signalisation...
- 15 - Les commandes à distance (cordes, flexible...) doivent être positionnées de façon à éviter le déclenchement accidentel d'une manœuvre génératrice de risque d'accident ou de dégâts.
- 16 - Mettez la machine en position de transport conformément aux indications avant de vous engager sur la voie publique.
- 17 - Ne quittez jamais le poste de conduite lorsque le tracteur est en marche.
- 18 - Adaptez la vitesse et le mode de conduite au terrain. Évitez les brusques changements de direction.
- 19 - La tenue de route, la direction et le freinage sont influencés par les outils portés et tractés. Pour ces raisons, soyez vigilant et veillez à avoir suffisamment de réponse avec la direction et les organes de freinage.
- 20 - Dans les virages, tenez compte des objets en saillie, des porte-à-faux et de la masse d'inertie.
- 21 - Assurez-vous de la mise en place et du bon état des dispositifs de protection avant chaque utilisation.
- 22 - Avant chaque utilisation, contrôlez le serrage des vis et des écrous.
- 23 - Ne stationnez pas dans la zone de travail de la machine.
- 24 - Des zones d'écrasement et de cisaillement peuvent exister sur les organes commandés à distance, notamment ceux asservis hydrauliquement.
- 25 - Veillez à couper le moteur, retirez la clé de contact et attendez l'arrêt complet de toutes les pièces en fonctionnement avant de descendre du tracteur ou d'effectuer toute opération sur la machine.
- 26 - Ne stationnez pas entre le tracteur et la machine sans avoir préalablement serré le frein de parcage et / ou placé des cales sous les roues.
- 27 - Avant toute intervention sur la machine, assurez-vous que celle-ci ne puisse être mise en route accidentellement.
- 28 - Ne pas utiliser l'anneau de levage pour soulever la machine lorsque celle-ci est chargée.

## **UTILISATION CONFORME DE LA MACHINE**

Le semoir ne doit être utilisé que pour les travaux pour lesquels il a été conçu.

Tout dommage lié à l'utilisation de la machine en dehors du domaine indiqué par le constructeur n'engagera en aucun cas la responsabilité de celui-ci.

Toute modification de la machine se fera aux risques et périls de l'utilisateur.

La bonne utilisation de la machine nécessite:

- le respect des notices d'utilisation, d'entretien et maintenance constructeur
- l'utilisation impérative des pièces détachées et accessoires d'origine ou recommandés par le constructeur.

L'utilisation, entretien ou réparation ne se feront que par des personnes compétentes et informées des dangers auxquelles elles sont exposées.

L'utilisateur devra respecter les réglementations:

- de prévention contre les accidents
- de sécurité du travail (Code du travail)
- de circulation (Code de la route)

Veillez au respect des indications précisées sur les machines.

Toute modification du matériel, sans accord écrit du constructeur, engage l'entière responsabilité du propriétaire.

## **ATTELAGE**

1 - Lors de l'attelage de la machine au tracteur ou de sa dépose, le levier de commande du relevage hydraulique doit être placé de manière à ce que le relevage ne puisse s'effectuer.

2 - Lors de l'attelage de la machine au relevage 3 points du tracteur, les diamètres des broches ou tourillons devront bien correspondre au diamètre des rotules du tracteur.

3 - Risques d'écrasement et de cisaillement dans la zone de relevage 3 points.

4 - Lors de la manœuvre du levier de commande extérieur du relevage, veuillez à vous tenir éloigné de la zone située entre le tracteur et la machine.

5 - Lors du transport de la machine, veuillez à bien stabiliser par des tirants de rigidification du relevage afin d'éviter d'éventuels frottements ou débattements latéraux.

6 - En cas de transport de la machine en mode relevé, veuillez à ce que le levier de commande du relevage soit bien verrouillé.

## **ORGANES D'ANIMATION (Prises de force et arbres de transmission à cardans)**

1 - Veuillez à utiliser les arbres de transmission à cardans fournis avec la machine ou préconisés par le constructeur.

2 - Veuillez au bon état et à la bonne mise en place des carters de protection des prises de force et arbres de transmission.

3 - Veuillez au bon recouvrement des tubes des arbres de transmission à cardans, en position de travail et en position de transport.

4 - Veuillez à débrayer la prise de force, couper le moteur, et retirer la clé de contact avant toute connexion ou déconnexion d'un arbre de transmission à cardans.

5 - En cas d'arbre de transmission avec un limiteur de couple ou une roue libre, ils devront impérativement être montés sur la prise de force de la machine.

6 - Le montage et le verrouillage des arbres de transmission à cardans devront être effectués correctement.

7 - Les carters de protection des arbres de transmission à cardans doivent être immobilisés en rotation grâce à des chaînettes.

8 - Contrôler que le régime choisi et le sens de rotation de la prise de force soit conforme aux préconisations du constructeur, avant l'embrayage de la prise de force.

9 - Embrayer la prise de force si vous vous êtes assuré qu'il n'y a aucune personne ou animal près de la machine.

10 - Débrayer la prise de force si les limites de l'angle de l'arbre de transmission à cardans recommandées par le constructeur risquent d'être dépassées.

11 - Après le débrayage de la prise de force, ne pas s'en approcher avant l'arrêt total car des éléments peuvent continuer à tourner quelques instants.

12 - Les arbres de transmission à cardans doivent être posés sur leur support lors de la dépose de la machine.

13 - Couvrir de son capuchon protecteur l'arbre de transmission à cardans de la prise de force du tracteur après sa déconnexion.

14 - Tout carter de protection de prise de force et d'arbre de transmission à cardans endommagé doit être immédiatement remplacé.

## **CIRCUIT HYDRAULIQUE**

1 - Le circuit hydraulique est sous pression

2 - Veuillez au bon branchement des circuits lors du montage de vérins ou de moteurs hydrauliques, selon les directives du constructeur.

3 - Vérifier que les circuits côté tracteur et côté machine ne sont pas sous pression avant tout branchement de flexible au circuit hydraulique du tracteur.

4 - Afin d'éviter tout risque d'inversion des fonctions ou erreur de branchement, nous recommandons de suivre les repères d'identification sur les raccords hydrauliques entre le tracteur et la machine.

5 - Vérifier une fois par an les flexibles hydrauliques:

- blessure et porosité de la couche extérieure
- déformation avec et sans pression
- état des raccords et joints

Le remplacement des flexibles doit se faire avant 6 ans d'utilisation, et selon les recommandations du constructeur.

6 - Si une fuite apparaît, veuillez à prendre les dispositions pour éviter tout accident.

7 - Tout liquide sous pression, comme l'huile du circuit hydraulique, peut provoquer de graves blessures, perforer la peau..., il convient en cas de blessure de contacter immédiatement un médecin et éviter ainsi un risque d'infection.

8 - La machine devra être abaissée, le circuit hors pression, le moteur coupé et la clé de contact retirée avant toute intervention sur le circuit hydraulique.

## **CONSIGNES D'ENTRETIEN**

1 - La prise de force devra impérativement être débrayée, le moteur coupé et la clé de contact retirée avant tous travaux de maintenance, entretien ou réparation de la machine.

2 - Le serrage des vis et écrous devra être effectué régulièrement. Après les premières heures d'utilisation (4 heures), toutes les vis doivent être resserrées puis refaire l'opération toutes les 80 heures.

3 - Avant tous travaux d'entretien sur une machine relevé, étayer celle-ci.

4 - Portez des gants et n'utilisez que l'outillage adéquat pour tout remplacement d'une pièce travaillante.

5 - Pour le respect de l'environnement, il est interdit de jeter de huile, graisse, ou filtres.

6 - La déconnexion de la source d'énergie devra être effectuée avant toute intervention sur le circuit électrique.

7 - Il convient de vérifier régulièrement les pièces exposées à une usure, et les remplacer si usées ou endommagées.

8 - L'utilisation de pièces de rechange MONOSEM est impérative, celles-ci correspondant aux caractéristiques définies par le constructeur.

9 - Les câbles de l'alternateur et de la batterie doivent être débranchés avant tous travaux de soudure électrique sur le tracteur ou la machine attelée.

10 - Seul un personnel qualifié peut intervenir pour effectuer des réparations impliquant des organes sous tension ou pression.

# 1 - SAFETY REGULATIONS

The machine should only be used, maintained and repaired by trained employees who are aware of the risks involved. It is essential to respect the safety regulations mentioned on the machine and accessory stickers and those given in this manual.

Before transporting the machine on public highways, it is essential to ensure that the current Highway Code is observed and that the machine complies with occupational safety regulations.

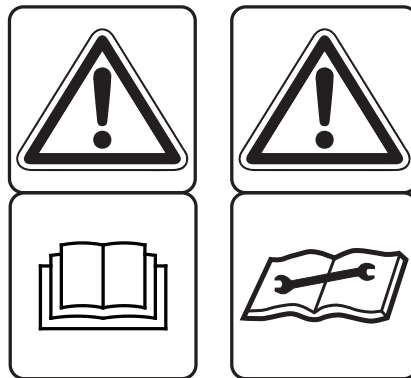

Follow all recommended precautions :

- P.T.O: see attached precaution sheet.
- Do not work under the planter.
- Row markers: keep clear of the load.
- Lofding frames: keep clear of the load.

**ATTENTION:** Because of its weight, do not leave the plater resting Only on its 2 central drive wheels. Attaching or detaching the plater when the plante ris stacked is strictly forbidden, the plater must be unstacked for these operations.

- Handling dangerous products: see instructions of manufacturer.

## GENERAL

- 1 - In addition to the instructions contained in this manual, legislation relating to safety instructions and accident prevention should be complied with.
- 2 - Warnings affixed to the machine give indications regarding safety measures to be observed and help to avoid accidents.
- 3 - When travelling on public roads, abide by the provisions of the Highway Code.
- 4 - Before starting work, it is essential that the user familiarizes himself with the control and operating elements of the machine and their respective functions. When the machine is running, it may be too late.
- 5 - The user should avoid wearing loose clothing which may be caught up in the moving parts.
- 6 - We recommend using a tractor with a safety cab or roll bar conforming to standards in force.
- 7 - Before starting up the machine and beginning work, check the immediate surroundings, particularly for children. Make sure that visibility is adequate. Clear any persons or animals out of the danger zone.
- 8 - It is strictly forbidden to transport any persons or animals on board the machine whether it is in operation or not.
- 9 - The machine should only be coupled up to the tractor at the specially provided towing points and in accordance with applicable safety standards.
- 10 - Extreme care must be taken when coupling or uncoupling the machine from the tractor.
- 11 - Before hitching up the machine, ensure that the front axle of the tractor is sufficiently weighted. Ballast weights should be fitted to the special supports in accordance with the instructions of the tractor manufacturer.
- 12 - Do not exceed the maximum axle weight or the gross vehicle weight rating.
- 13 - Do not exceed the maximum authorized dimensions for using public roads.
- 14 - Before entering a public road, ensure that the protective and signalling devices (lights, reflectors, etc.) required by law are fitted and working properly.
- 15 - All remote controls (cords, cables, rods, hoses, etc.) must be positioned so that they cannot accidentally set off any manoeuvre which may cause an accident or damage.
- 16 - Before entering a public road, place the machine in the transport position, in accordance with the manufacturer's instructions.
- 17 - Never leave the driver's position whilst the tractor is running.
- 18 - The speed and the method of operation must always be adapted to the land, roads and paths. Avoid sudden changes of direction under all circumstances.
- 19 - Precision of the steering, tractor adhesion, road holding and effectiveness of the braking mechanism are influenced by factors such as the weight and nature of the machine being towed, the front axle stage and the state of the land or path. It is essential, therefore, that the appropriate care is taken for each situation.
- 20 - Take extra care when cornering, taking account of the overhang, length, height and weight of the machine or trailer being towed.
- 21 - Before using the machine, ensure that all protective devices are fitted and in good condition. Damaged protectors should be replaced immediately.
- 22 - Before using the machine, check that nuts and screws are tight, particularly those for attaching tools (discs, flickers, deflectors, etc.). Tighten if necessary.
- 23 - Do not stand in the operation area of the machine
- 24 - Caution! Be aware of any crushing and shearing zones on remote-controlled parts
- 25 - Before climbing down from the tractor, or before any operation on the machine, turn off the engine, remove the key from the ignition and wait until all moving parts have come to a standstill.
- 26 - Do not stand between the tractor and the machine until the handbrake has been applied and/or the wheels have been wedged.
- 27 - Before any operation on the machine, ensure that it cannot be started up accidentally.
- 28 - Do not use the lifting ring to lift the machine when it is loaded.



## **PROPER USE OF THE MACHINE**

The machine must only be used for tasks for which it has been designed.

The manufacturer will not be liable for any damage caused by using the machine for applications other than those specified by the manufacturer. Any changes made to the machine are carried out entirely at the user's risk.

Proper use of the machine also implies:

- complying with instructions on use, care and maintenance provided by the manufacturer;
- using only original or manufacturer recommended spare parts, equipment and accessories.

The machine must only be operated, maintained and repaired by competent persons. Who are aware of the risks relating to operating the machine.

The user must strictly abide by current legislation regarding:

- accident prevention
- safety at work (health and safety regulations)
- transport on public roads (road traffic regulations)

Strict compliance with warnings affixed to the machine is obligatory.

The owner of the equipment shall become liable for any damage resulting from alterations made to the machine by the user or any other person, without the prior written consent of the manufacturer.

## **HITCHING**

1 - When hitching or unhitching the machine from the tractor, place the control lever of the hydraulic lift in a position that prevents the lifting mechanism from being activated accidentally.

2 - When hitching the machine to the three-point lifting mechanism of the tractor, ensure that the diameters of the pins or gudgeons correspond to the diameter of the tractor ball joints.

3 - Caution! In the three points lifting zone, there may be a danger of crushing and shearing.

4 - Do not stand between the tractor and the machine whilst operating the external lift control lever.

5 - When in transport, lifting mechanism stabilizer bars must be fitted to the machine to prevent friction and side movement.

6 - When transporting the machine in the raised position, lock the lift control lever.

## **DRIVE EQUIPMENT (Power take-off and universal drive shafts)**

1 - Only use universal shafts supplied with the machine or recommended by the manufacturer.

2 - Power take-off and universal drive shaft guards must always be fitted and in good condition.

3 - Ensure that the tubes of the universal drive shafts are properly guarded, both in the working position and in the transport position.

4 - Before connecting or disconnecting a universal drive shaft, disengage the power take-off, turn off the engine and re-move the key from ignition.

5 - If the primary universal drive shaft is fitted with torque limiter or a free wheel, these must be mounted on the machine power take-off.

6 - Always ensure that universal drive shafts are fitted and locked correctly.

7 - Always ensure that universal drive shafts guards are immobilized in rotation using the specially provided chains.

8 - Before engaging power take-off, ensure that the speed selected and the direction of rotation of the power take-off comply with the manufacturer's instructions.

9 - Before engaging power take-off, ensure that no persons or animals are close to the machine.

10 - Disengage power take-off when the universal drive shaft angle limits laid down by the manufacturer are in danger of being exceeded.

11 - Caution! When power take-off has been disengaged, moving parts may continue to rotate for a few moments. Do not approach until they have reached a complete standstill.

12 - On removal from the machine, rest the universal drive shafts on the specially provided supports.

13 - After disconnecting the power take-off universal drive shaft of the tractor, cover it with its protective cap.

14 - Damaged power take-off and universal drive shaft guards must be replaced immediately.

## **HYDRAULIC CIRCUIT**

1 - Caution! The hydraulic circuit is pressurized.

2 - When fitting hydraulic motors or cylinders, ensure that the circuits are connected correctly in accordance with the manufacturer's guidelines.

3 - Before fitting a hose to the tractor's hydraulic circuit, ensure that the tractor side and the machine side circuits are not pressurized.

4 - The user of the machine is strongly advised to identify the hydraulic couplings between the tractor and the machine in order to prevent connection errors. . Caution! There is a danger of reversing the functions (for example: raise/lower).

5 - Check hydraulic hoses once a year:

- damage to the outer surface
- porosity of the outer surface
- deformation with and without pressure
- condition of fittings and seals

Hoses must be replaced before 6 years of use, in accordance with the manufacturer's recommendations.

6 - When a leak is found, all necessary precautions should be taken to prevent accidents.

7 - Pressurized liquid, particularly hydraulic circuit oil, may cause serious injury if it comes into contact with the skin. In the case of injury, consult a doctor immediately. There is a risk of infection.

8 - Before carrying out any work on the hydraulic circuit, lower the machine, release the pressure from the circuit, turn off the engine and remove the key from ignition.

## **MAINTENANCE**

1 - Before commencing any maintenance, servicing or repair work, it is essential that the power take-off is disengaged, the engine turned off and the key removed from the ignition.

2 - Check regularly that nuts and screws are not loose. Tighten if necessary. After the first few hours of use (4 hours), all screws must be tightened. Then repeat the operation every 80 hours.

3 - Before carrying out maintenance work on a raised machine, prop it up using appropriate means of support.

4 - When replacing a working part, wear protective gloves and only use appropriate tools.

5 - To protect the environment, it is forbidden to throw away oil, grease or filters of any kind.

6 - Before carrying out any work on the electric circuit, disconnect the power source.

7 - Parts subject to wear and tear should be checked regularly. Replace them immediately if they are damaged or worn

8 - Spare parts should comply with the standards and specifications laid down by the manufacturer. Only use MONOSEM spare parts.

9 - Before commencing any electric welding work on the tractor or the towed machine, disconnect the alternator and battery cables.

10 - Repairs affecting parts under stress or pressure should be carried out by suitably qualified engineers.

# 1 - PRESCRIPCIONES DE SEGURIDAD

Esta máquina sólo puede ser utilizada, mantenida y reparada por personal especializado y conocedor de los riesgos que ello conlleva. Respetar siempre las instrucciones de seguridad que aparecen en las pegatinas de la máquina, en sus accesorios y en este manual. Antes de desplazar la máquina por una vía pública, asegurarse siempre de que se respeta el Código de Circulación vigente y que se realiza de acuerdo con la normativa en materia de seguridad en el trabajo.

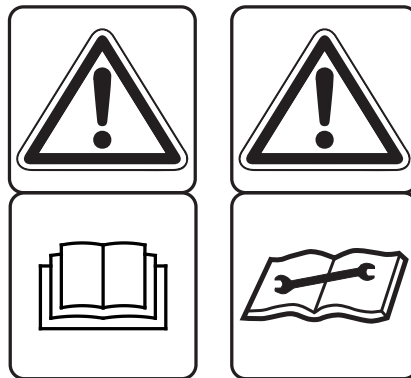

**Atención a los consejos de seguridad :**

- **Toma de fuerza: ver información adjunta.**
- **No trabajar bajo la sembradora.**
- **Trazadores: no colocarse debajo.**
- **Chasis plegables: no colocarse debajo.**

**ATENCIÓN: A causa de su peso importante, no deje la sembradora apoyada únicamente sobre sus dos ruedas centrales. Se prohíbe enganchar o desenganchar la máquina plegada: debe guardarse abierta.**

- **Manipulación de productos peligrosos: ver el embalaje.**

## **CONSIGNAS GENERALES DE SEGURIDAD**

- 1 - Como complemento a las instrucciones que figuran en este manual, respetar la legislación en materia de seguridad y prevención de accidentes.
- 2 - Las pegatinas que lleva la máquina y sus accesorios proporcionan indicaciones importantes para usarla sin ningún riesgo. Respetándolas, se garantiza su seguridad.
- 3 - Respetar el Código de Circulación cuando se circule por la vía pública.
- 4 - Es preciso familiarizarse con el uso de la máquina antes de empezar a trabajar con ella. Durante el trabajo, será demasiado tarde.
- 5 - El usuario debe evitar llevar ropa demasiado holgada por el peligro de ser atrapado por componentes en movimiento.
- 6 - Se recomienda usar un tractor equipado con una cabina o un arco de seguridad, conforme a la normativa vigente.
- 7 - Asegurarse de que en las proximidades de la máquina no hay obstáculos (ni niños).
- 8 - Está prohibido transportar a personas o animales durante el trabajo y el transporte de la máquina.
- 9 - Enganchar la máquina en los puntos de enganche previstos a tal efecto, según la normativa vigente.
- 10 - Las operaciones de enganche y desenganche deben realizarse con precaución.
- 11 - Al desengancharla, asegurarse de la correcta posición de los soportes para una correcta estabilidad de la máquina.
- 12 - Antes de enganchar la máquina, asegurarse de que el eje delantero del tractor está correctamente lastrado.
- 13 - La colocación de cargas debe realizarse en los soportes previstos a tal efecto, conforme a las instrucciones del fabricante del tractor y respetando siempre las cargas máximas por eje y el peso total autorizado en carga.
- 14 - Utilizar y controlar los equipos reglamentarios durante el transporte: alumbrado, señalización...
- 15 - Los medios de control a distancia (cuerdas, cables...) deben colocarse correctamente con el fin de que no se produzcan maniobras de forma accidental que puedan provocar riesgos de accidente o de daños.
- 16 - Poner la máquina en posición de transporte conforme a las indicaciones antes transitar por la vía pública.
- 17 - No abandonar nunca el puesto de conducción cuando el tractor está en marcha.
- 18 - Adaptar la velocidad y el modo de conducción al terreno. Evitar los cambios bruscos de dirección.
- 19 - Las herramientas transportadas o remolcadas influyen sobre la adherencia, la dirección y el frenado. Por este motivo, prestar especial atención y procurar tener suficiente margen de respuesta con la dirección y los dispositivos de frenado.
- 20 - En las curvas, prestar atención a los objetos salientes, voladizos y a la masa inerte.
- 21 - Asegurarse de la presencia y el buen estado de los dispositivos de protección antes de cada uso.
- 22 - Antes de cada uso, asegurarse de que los tornillos y las tuercas están bien apretados.
- 23 - No estacionar en la zona de trabajo de la máquina.
- 24 - Pueden existir zonas de aplastamiento y cizallamiento en los órganos controlados a distancia, especialmente los de accionamiento hidráulico.
- 25 - Apagar el motor, retirar la llave de contacto y esperar a que se paren completamente todas las piezas en funcionamiento antes de bajar del tractor o efectuar cualquier operación sobre la máquina.
- 26 - No estacionar entre el tractor y la máquina sin haber accionado previamente el freno de estacionamiento y/o colocado calces debajo de las ruedas.
- 27 - Antes de cualquier intervención sobre la máquina, asegurarse de que no puede ponerse en marcha accidentalmente.
- 28 - No utilice el ojo de levantar para levantar la máquina cuando está cargado.



## **USO ADECUADO DE LA MÁQUINA**

Esta sembradora sólo puede usarse para los trabajos para los que ha sido concebida.

El fabricante no se hará responsable de los daños provocados por usar la máquina fuera del ámbito por él indicado.

Las modificaciones que se realicen sobre la máquina serán por cuenta y riesgo del usuario.

El correcto uso de la máquina exige:

- el respeto de los manuales de uso y mantenimiento del fabricante.
- el uso obligatorio de las piezas de recambio, los accesorios originales o piezas recomendadas por el fabricante.

El uso, el mantenimiento o la reparación serán efectuados por personas competentes y conocedoras de los peligros a los que se exponen.

El usuario deberá respetar la normativa en materia de:

- prevención de accidentes
- seguridad en el trabajo (Código del Trabajo)
- Circulación (Código de Circulación)

Respetar las indicaciones que figuran en las máquinas.

El propietario será totalmente responsable de cualquier modificación realizada sobre el material, sin el consentimiento del fabricante expresado por escrito.

## **ENGANCHE**

1 - Al enganchar o desenganchar la máquina al tractor, la palanca de control de la elevación hidráulica debe colocarse de manera que se impida la elevación.

2 - Al enganchar la máquina en la elevación de 3 puntos del tractor, los diámetros de los pasadores o espigas deberán coincidir con el diámetro de las rótulas del tractor.

3 - Riesgos de aplastamiento o cizallamiento en la zona de elevación de 3 puntos.

4 - Al accionar la palanca de control exterior de la elevación, mantenerse alejado de la zona situada entre el tractor y la máquina.

5 - Durante el transporte de la máquina, estabilizarla bien mediante tirantes de rigidización de la elevación con el fin de evitar roces o desplazamientos laterales.

6 - En caso de transporte de la máquina en modo elevado, asegurarse de que la palanca de control de la elevación esté bien bloqueada.

## **ÓRGANOS DE ANIMACIÓN (tomas de fuerza y árboles de transmisión de cardán)**

1 - Utilizar los árboles de transmisión de cardán suministrados con la máquina o recomendados por el fabricante.

2 - Comprobar que los cárteres de protección de las tomas de fuerza y los árboles de transmisión están en buen estado y bien colocados.

3 - Comprobar el recubrimiento de los tubos de los árboles de transmisión de cardán, en posición de trabajo y en posición de transporte.

4 - Desacoplar la toma de fuerza, apagar el motor y retirar la llave de contacto antes de conectar o desconectar un árbol de transmisión de cardán.

5 - En caso de que el árbol de transmisión lleve un limitador de par o una rueda libre, deberán montarse siempre sobre la toma de fuerza de la máquina.

6 - El montaje y el bloqueo de los árboles de transmisión de cardán deberá efectuarse correctamente.

7 - Los cárteres de protección de los árboles de transmisión de cardán deberán ser inmovilizados en rotación mediante cadenas.

8 - Controlar que el régimen seleccionado y el sentido de rotación de la toma de fuerza sigan las recomendaciones del fabricante, antes de embragar la toma de fuerza.

9 - No embragar la toma de fuerza hasta estar seguro de que no hay ninguna persona ni animal cerca de la máquina.

10 - Desembragar la toma de fuerza si los límites del ángulo del árbol de transmisión de cardán recomendados por el constructor van a ser superados.

11 - Después de desembragar la toma de fuerza, no acercarse antes de la parada total, pues puede haber elementos que sigan girando durante unos instantes.

12 - Los árboles de transmisión de cardán deben ser colocados sobre sus soportes al desenganchar la máquina.

13 - Cubrir el árbol de transmisión de cardán de la toma de fuerza del tractor con su capuchón protector después de su conexión.

14 - El cárter de protección de la toma de fuerza y el árbol de transmisión de cardán deben sustituirse inmediatamente si tienen algún desperfecto.

## **CIRCUITO HIDRÁULICO**

1 - El circuito hidráulico está bajo presión.

2 - Conectar correctamente los circuitos durante el montaje de los cilindros o motores hidráulicos, según las directrices del fabricante.

3 - Antes de conectar un latiguillo al circuito hidráulico del tractor, comprobar que los circuitos del tractor y de la máquina no están bajo presión.

4 - Para evitar riesgos de inversión de las funciones o errores de conexión, recomendamos seguir la información de identificación sobre los racores hidráulicos entre el tractor y la máquina.

5 - Revisar una vez al año los latiguillos hidráulicos:

- ausencia de grietas o poros en la capa exterior
- ausencia de deformación con y sin presión
- buen estado de racores y juntas.

La sustitución de los latiguillos debe realizarse antes de los 6 años de uso, y según las recomendaciones del fabricante.

6 - Si se produce una fuga, tomar las medidas necesarias para evitar accidentes.

7 - Los líquidos bajo presión, como el aceite del circuito hidráulico, pueden provocar graves lesiones, perforar la piel, etc. En caso de lesión, acudir inmediatamente a un médico y evitar los riesgos de infección.

8 - Antes de intervenir en el circuito hidráulico, bajar la máquina, quitar la presión del circuito, apagar el motor y retirar la llave de contacto.

## **INSTRUCCIONES DE MANTENIMIENTO**

1 - Antes de realizar trabajos de mantenimiento o reparación en la máquina, desembragar siempre la toma de fuerza, apagar el motor y retirar la llave de contacto.

2 - Apretar con regularidad las tuercas y tornillos. Tras las primeras horas de uso (4 horas), es necesario volver a apretar todos los tornillos y repetir esta operación cada 80 horas.

3 - Antes de efectuar trabajos de mantenimiento sobre una máquina elevada, apuntalarla.

4 - Llevar guantes y usar sólo las herramientas adecuadas para reemplazar las piezas en funcionamiento.

5 - Está prohibido verter aceite o grasa o tirar filtros con el fin de respetar el medio ambiente.

6 - Antes de intervenir sobre el circuito eléctrico, desconectar la fuente de energía.

7 - Conviene revisar regularmente las piezas expuestas a desgaste y reemplazarlas en caso de que están desgastadas o deterioradas.

8 - Es obligatorio el uso de piezas de recambio MONOSEM, pues responden a las características establecidas por el fabricante.

9 - Antes de efectuar trabajos de soldadura eléctrica en el tractor o la máquina enganchada, desconectar los cables del alternador y de la batería.

10 - Las reparaciones sobre órganos bajo tensión o bajo presión sólo pueden ser efectuadas por personal cualificado.

# 1 - PRESCRIZIONI DI SICUREZZA

La macchina deve essere utilizzata e riparata da personale esperto e avvertito dei rischi inerenti.

Rispettare le norme di sicurezza poste sugli adesivi della macchina e degli accessori di manuale.

Prima di ogni spostamento su strade pubbliche, è necessario assicurarsi del rispetto delle disposizioni del codice della strada in vigore e della conformità con la regolamentazione in materia di sicurezza del lavoro.

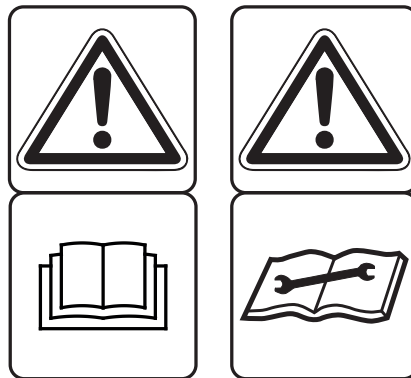

**Attenzione ai consigli di sicurezza :**

- Presa di forza : vedere notizia allegata.
- Non lavorare sotto la seminatrice.
- Tracciatori : non sostare sotto il carico.
- Telaio ripieghevole : non sostare sotto il carico.

**ATTENZIONE : A causa del suo peso importante, non lasciare la seminatrice in appoggio unicamente sui 2 blocchi ruote centrali. È vietato attaccare o staccare la macchina piegata. Questa deve essere Lasciata spiegata per tali lavori.**

- manipolazione di prodotti chimici pericolosi : vedere notizie sui contenitori.

## GENERALITÀ

- 1 - Rispettare, oltre alle istruzioni contenute in questo foglietto, la legislazione relativa alle prescrizioni di sicurezza e di prevenzione d' incidenti.
- 2 - Gli avvisi apposti sulla macchina sono delle indicazioni sulle misure di sicurezza da osservare e contribuiscono a evitare incidenti.
- 3 - Durante la circolazione su strada pubblica, rispettare le norme del Codice della Strada
- 4 - Prima di iniziare a lavorare, l'operatore dovrà obbligatoriamente prendere mano con gli organi di controllo e manovra della macchina e le loro rispettive funzioni. In fase di lavoro sarà troppo tardi per farlo.
- 5 - L'operatore deve evitare di indossare indumenti svolazzanti che potrebbero rischiare di essere aggrappati dagli elementi in movimento
- 6 - Si consiglia di utilizzare un trattore fornito di cabina o di archetto di sicurezza, conformemente alle norme in vigore.
- 7 - Prima di avviare la macchina e di iniziare i lavori, controllare i pericoli imminenti (bambini!). Cercare di avere una visibilità sufficiente ! Allontanare qualsiasi persona o animale dalla zona di pericolo della macchina (prevedere!).
- 8 - Il trasporto di persone o animali sulla macchina durante il lavoro o durante gli spostamenti è severamente vietato.
- 9 - L'accoppiamento della macchina al trattore deve essere effettuato esclusivamente sui punti di attacco previsti per questa operazione conformemente alle norme vigenti di sicurezza.
- 10 - La prudenza è di rigore durante l'attacco della macchina al trattore e durante lo sganciamento!
- 11 - Prima di attaccare la macchina, converrà assicurarsi che lo zavorramento dell'assale davanti al trattore sia sufficiente. La messa in atto di masse di zavorramento deve essere effettuata sui supporti previsti per questa operazione conformemente alle indicazioni del costruttore del trattore.
- 12 - Rispettare il carico massimo dell'assale e il peso totale in movimento autorizzato in carico.
- 13 - Rispettare la sagoma massima su strada pubblica.
- 14 - Prima di immettersi su strada, controllare la presenza e il buono stato delle protezioni e dei dispositivi di segnalazione (luminosi, catarifrangenti...) previsti dalla legge.
- 15 - Tutti i comandi a distanza (corda, cavo, asta, flessibile...) devono essere posizionati in modo tale che non possano causare accidentalmente una manovra causa di rischio d'incidente o danni.
- 16 - Prima di immettersi su strada, posizionare la macchina in posizione di trasporto, conformemente alle disposizioni del costruttore
- 17 - Non abbandonare mai il posto di guida quando il trattore è in funzione.
- 18 - La velocità e la modalità di guida devono essere sempre idonei al terreno, strade e percorsi. In ogni circostanza, evitare cambi di direzione bruschi.
- 19 - La precisione nella direzione, l'aderenza del trattore, la tenuta di strada e l'efficacia dei dispositivi di frenaggio sono influenzati da fattori quali: peso e natura della macchina agganciata, zavorramento dell'assale anteriore, stato del terreno o della carreggiata. È dunque obbligatorio il rispetto delle regole di prudenza dettate da ogni situazione.
- 20 - Prestate ulteriore attenzione nelle sterzate tenendo conto delle sporgenze, della lunghezza, dell'altezza e del peso della macchina o del rimorchio agganciato.
- 21 - Prima di ogni utilizzo della macchina, accertarsi che tutti i dispositivi di protezione siano presenti e in buono stato. Le protezioni danneggiate devono essere obbligatoriamente sostituite.
- 22 - Prima di ogni utilizzo della macchina, controllare il serraggio delle viti e dei dadi, in particolare di quelli che fissano gli strumenti (dischi, palette, deflettori...). Avvitare se necessario.
- 23 - Non sostare nella zona di manovra della macchina.
- 24 - Attenzione! Possono esistere sugli organi di controllo a distanza delle aree di schiacciamento e taglio, soprattutto su quelli motorizzati idraulicamente.
- 25 - Prima di scendere dal trattore, o preliminarmente a qualsiasi intervento sulla macchina, spegnere il motore, togliere la chiave di accensione e attendere l'arresto totale di tutte le parti in movimento.
- 26 - Non sostare tra il trattore e la macchina senza avere prima tirato il freno a mano e/o avere sistemato dei cunei sotto le ruote.
- 27 - Prima di ogni intervento sulla macchina, assicurarsi che questa non possa avviarsi accidentalmente.
- 28 - Non utilizzare l'anello di sollevamento per sollevare la macchina quando è piena.

## **UTILIZZO CONFORME DELLA MACCHINA**

La seminatrice deve essere utilizzata unicamente per gli scopi per cui è stata concepita.

In caso di danno legato all'utilizzo della macchina al di fuori del quadro delle sue applicazioni indicate, il costruttore non è soggetto ad alcuna responsabilità. Ogni estrapolazione dalla destinazione di origine della macchina sarà fatta a rischio e pericolo dell'operatore.

L'utilizzo conforme della macchina implica allo stesso modo:

- il rispetto delle norme d'uso, di manutenzione e mantenimento formulate dal costruttore,
- l'utilizzo esclusivo dei pezzi di ricambio, attrezzatura e accessori originali o raccomandati dal costruttore.

La seminatrice deve essere utilizzata, conservata e riparata unicamente da persone competenti, a conoscenza delle caratteristiche e delle modalità di utilizzo della macchina. Queste persone devono inoltre essere informate dei pericoli a cui potranno essere esposte.

L'operatore è tenuto a rispettare scrupolosamente la regolamentazione in vigore in materia di:

- prevenzione degli incidenti,
- sicurezza del lavoro (Codice del Lavoro)
- circolazione su strada pubblica (Codice della Strada)

Gli è inoltre fatto obbligo di osservare severamente gli avvisi posti sulla macchina,

Ogni modifica della macchina effettuata dall'operatore stesso o da qualsiasi altra persona, senza l'accordo scritto preliminare del costruttore implicherà la responsabilità del proprietario del materiale modificato.

## **AGGANCIAMENTO**

1 - In fase di aggancio della macchina al trattore o della sua rimozione, mettere la leva di comando di sollevamento idraulico in una posizione in cui qualsiasi avviamento del sollevamento non possa intervenire in maniera improvvisa.

2 - In fase di aggancio della macchina al sollevamento su 3 punti del trattore, controllate che i diametri dei mandrini o dei perni corrispondano bene ai diametri delle rotule del trattore.

3 - Attenzione! Nella zona di sollevamento su 3 punti, possono presentarsi dei rischi di schiacciamento e di taglio!

4 - Non mettersi tra il trattore e la macchina durante la manovra della leva di comando esterna del sollevamento.

## **ORGANI DI ANIMAZIONE (Prese di forza e alberi di trasmissione a cardani)**

1 - Utilizzare unicamente gli alberi di trasmissione a cardani forniti con la macchina o raccomandati dal costruttore.

2 - Le protezioni delle prese di forza e degli alberi di trasmissione a cardani devono sempre essere presenti e in buono stato.

3 - Effettuare una corretta copertura dei tubi degli alberi di trasmissione a cardani sia in posizione di lavoro che in posizione di trasporto.

4 - Prima di collegare o scollegare un albero di trasmissione a cardani, staccare la presa di forza, spegnere il motore e togliere la chiave di accensione.

5 - Se l'albero di trasmissione a cardani primario è fornito di un limitatore di coppia o di una ruota libera, questi elementi devono imperativamente essere montati sulla presa di forza della macchina.

6 - Controllare sempre il corretto montaggio e bloccaggio degli alberi di trasmissione a cardani.

7 - Controllare sempre che le protezioni degli alberi di trasmissione a cardani siano immobilizzate in rotazione con le catenelle previste per questa operazione.

8 - Prima di attaccare la presa di forza, assicurarsi che il regime scelto e il verso di rotazione della presa di forza siano conformi alle indicazioni del costruttore.

9 - Prima di attaccare la presa di forza, assicurarsi che nessuna persona o nessun animale si trovino in prossimità della macchina.

10 - Scollegare la presa di forza quando i limiti dell'angolo dell'albero di trasmissione a cardani indicati dal costruttore rischiano di essere superati.

11 - Attenzione! Dopo aver scollegato la presa di forza, gli elementi in movimento possono continuare a girare ancora alcuni istanti. Non avvicinarsi prima dell'arresto totale.

12 - Durante la rimozione della macchina, far riposare gli alberi di trasmissione a cardani sui supporti previsti per questa operazione.

13 - Dopo aver scollegato l'albero di trasmissione a cardani dalla presa di forza del trattore, quest'ultima deve essere ricoperta con il suo cappuccio di protezione.

14 - Le protezioni della presa di forza e degli alberi di trasmissione a cardani danneggiati devono essere immediatamente sostituite.

## **CIRCUITO IDRAULICO**

1 - Attenzione! il circuito idraulico è a pressione.

2 - In fase di montaggio dei martinetti o dei motori idraulici, controllare attentamente il corretto collegamento dei circuiti, conformemente alle disposizioni del costruttore.

3 - Prima di collegare un flessibile al circuito idraulico del trattore, assicurarsi che i circuiti del trattore e della macchina non siano pressurizzati.

4 - Si raccomanda vivamente l'operatore della macchina di seguire i punti di riferimento d'identificazione sui raccordi idraulici tra il trattore e la macchina al fine di evitare errori di collegamento. Attenzione! Può presentarsi il rischio di invertire alcune funzioni (ad esempio: sollevare/abbassare)

5 - Controllare una volta all'anno i flessibili idraulici:

- escoriazione dello strato esterno
- porosità dello strato esterno
- deformazione senza pressione e sotto pressione
- stato dei raccordi e dei giunti

La durata di utilizzo massima dei flessibili è di sei anni. Al momento della sostituzione, accertarsi di utilizzare flessibili con specifiche e qualità raccomandate dal costruttore della macchina.

6 - Nella localizzazione di una fuga, sarà consigliabile prendere ogni precauzione per evitare incidenti.

7 - Qualsiasi liquido pressurizzato, soprattutto l'olio del circuito idraulico, può perforare la pelle e causare gravi ferite! In caso di ferita, consultare un medico! Possono esistere pericoli di infezione!

8 - Prima di qualsiasi intervento sul circuito idraulico, abbassare la macchina, depressurizzare il circuito, spegnere il motore e togliere la chiave di accensione.

## **MANUTENZIONE**

1 - Prima di ogni lavoro di manutenzione, conservazione o riparazione e di ricerca dell'origine di un guasto o di un incidente di funzionamento, occorre obbligatoriamente scollegare la presa di forza, spegnere il motore e che rimuovere la chiave di accensione.

2 - Controllare regolarmente il serraggio delle viti e dei dadi. Avvitare se necessario! Dopo le prime ore di utilizzo (4 ore), occorre restringere tutte le viti, ripetere quindi questa operazione ogni 80 ore.

3 - Prima di procedere con lavori di manutenzione su una macchina in posizione rialzata, riporre a terra quest'ultima con un mezzo appropriato.

4 - Nella sostituzione di un pezzo di lavoro, (pala per i distributori o vomere per i seminatori), indossare dei guanti di protezione e utilizzare solo attrezzatura appropriata.

5 - Per il rispetto dell'ambiente, è vietato gettare o versare oli, grassi e filtri di alcun genere. Si consiglia di consegnarli a imprese specializzate nel loro smaltimento.

6 - Prima di qualsiasi intervento sul circuito elettrico, togliere l'alimentazione.

7 - I dispositivi di protezione suscettibili all'usura devono essere regolarmente controllati. Sostituirli immediatamente se risultano danneggiati.

8 - I pezzi di ricambio devono rispondere alle norme e alle specifiche indicate dal costruttore. Utilizzare solo pezzi di ricambio Monosem!

9 - Prima di intraprendere lavori di saldatura elettrica sul trattore o la macchina agganciata, scollegare i cavi dell'alternatore e della batteria.

10 - Le riparazioni che coinvolgono gli organi in tensione o a pressione (molle, accumulatori di pressione, ecc...) richiedono una sufficiente qualifica e un'attrezzatura specifica; così come personale qualificato.

	0.0 km/h			
	0.00 ha			
	13.3 cm			
		1 2 3 4		
$\Sigma \rightarrow$	100.0 Mg/ha	$\Sigma \sim$	0.0 Mg/ha	
	0.0 kg/ha			
	27.7 kg/ha			
	0.0 kg/ha			



NG Plus M<sub>E</sub>



NG Plus 4<sub>E</sub>



NX M<sub>E</sub>



MECA V4<sub>E</sub>

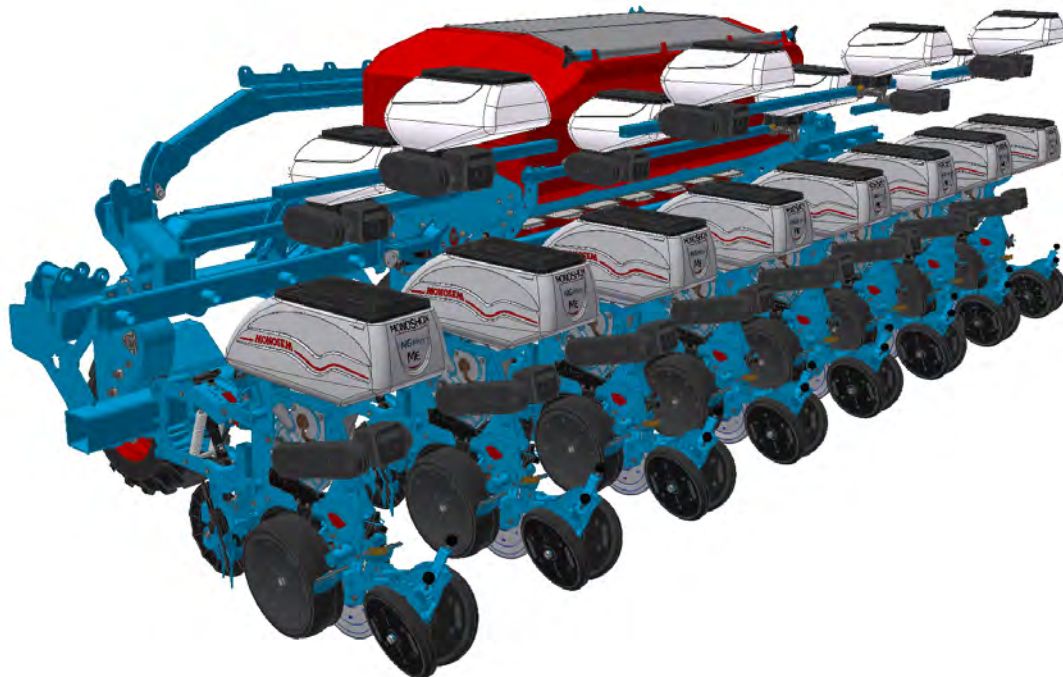

Semoir repliable TFC 2 FEP  
 FEP TFC 2 folding planter  
 Sembradora plegable TFC 2 FEP  
 Seminatrice pieghevole TFC 2 FEP

## 2 - INTRODUCTION

Le contrôleur de semis MONOSEM FEP ISOBUS est un dispositif qui offre la possibilité de commander électriquement le semoir depuis la cabine du tracteur. Ainsi on peut piloter les éléments semeurs, l'entraînement du Fertiliseur et des boîtiers Microsem. Il se monte sur les semoirs NG Plus ME - NG Plus 4E - NX ME et MECA V4E.

Le contrôleur de semis MONOSEM FEP ISOBUS possède les fonctionnalités suivantes:

- Réglage de la densité de semis depuis le terminal.
- Contrôle de la chute de graines, rang par rang.
- Comptage des graines sur chaque rang.
- Densité moyenne par hectare.
- Alarme si manque de graines.
- Alarme à seuil programmable par rapport à la densité moyenne.
- Vitesse de travail par radar.
- Surface semée totale ou partielle.
- Coupure des rangs électrique sur chaque rang.
- Jalonnage automatique programmable.
- Coupure de rang permanente.
- Gestion automatique par GPS des coupures (option).
- Gestion de la dose d'engrais.
- Gestion de la dose de Microsem.

## 2 - INTRODUCTION

The MONOSEM FEP ISOBUS sowing controller is a device that allows you to electrically control the planter from the tractor cab. In this way, you can control the seed units, drive of the fertilizer placement unit and Microsem units. It is fitted on NG Plus ME - NG Plus 4E - NX ME and MECA V4E planters.

The MONOSEM FEP ISOBUS sowing controller has the following functions:

- Setting the sowing density from the terminal.
- Checking seed dispensing, row by row.
- Metering the seeds on each row.
- Average density per hectare.
- Alarm if seed is skipped.
- Programmable threshold alarm in relation to average density.
- Working speed by radar.
- Total or partial area sowed.
- Electric row cut-off on each row
- Programmable automatic tramline system.
- Permanent row cut-off.
- Automatic management of cut-offs by GPS (available as an optional extra).
- Fertilizer amount management.
- Microsem amount management.

## 2 - INTRODUCCIÓN

El controlador de siembra MONOSEM FEP ISOBUS es un dispositivo que ofrece la posibilidad de controlar eléctricamente la sembradora desde la cabina del tractor. De este modo, se pueden accionar los elementos sembradores, el mantenimiento del Fertilizador y de las cajas Microsem. Va montado sobre las sembradoras NG Plus ME - NG Plus 4E - NX ME y MECA V4E.

El controlador de siembra MONOSEM FEP ISOBUS posee las siguientes funciones:

- Ajuste de la densidad de siembra desde la terminal.
- Control de caída de granos, fila por fila.
- Recuento de los granos en cada fila.
- Densidad media por hectárea.
- Alarma si hay falta de grano.
- Alarma de umbral programable respecto a la densidad media.
- Velocidad de trabajo por radar.
- Superficie sembrada total o parcial.
- Corte eléctrico de las filas en cada fila.
- Jalonado automático programable.
- Corte de fila permanente.
- Gestión automática por GPS de los cortes (opción).
- Gestión de la dosis de abono.
- Gestión de la dosis de Microsem.

## 2 - INTRODUZIONE

Il controllore di semina MONOSEM FEP ISOBUS è un dispositivo che consente di comandare elettricamente la seminatrice dalla cabina del trattore. Così, si possono pilotare gli elementi seminatori, l'azionamento del Fertilizzatore e delle scatole Microsem. Si monta sulle seminatrici NG Plus ME - NG Plus 4E - NX ME e MECA V4E.

Il controllore di semina MONOSEM FEP ISOBUS è dotato delle seguenti funzionalità:

- Regolazione della densità di semina dal terminale.
- Controllo della caduta di semi, fila per fila.
- Conteggio dei semi su ogni fila.
- Densità media per ettaro.
- Allarme se mancano semi.
- Allarme a soglia programmabile rispetto alla densità media.
- Velocità di lavoro via radar.
- Superficie seminata totale o parziale.
- Interruzione elettrica delle file su ogni fila.
- Picchettamento automatico programmabile.
- Interruzione permanente di fila.
- Gestione automatica tramite GPS delle interruzioni (opzione).
- Gestione della dose di concime.
- Gestione della dose di Microsem.



**APERÇU GÉNÉRAL - ARCHITECTURE FEP**  
**PERSPECTIVA GENERAL - ARQUITECTURA FEP**

**OVERVIEW - FEP ARCHITECTURE**  
**PANORAMICA GENERALE - ARCHITETTURA FEP**

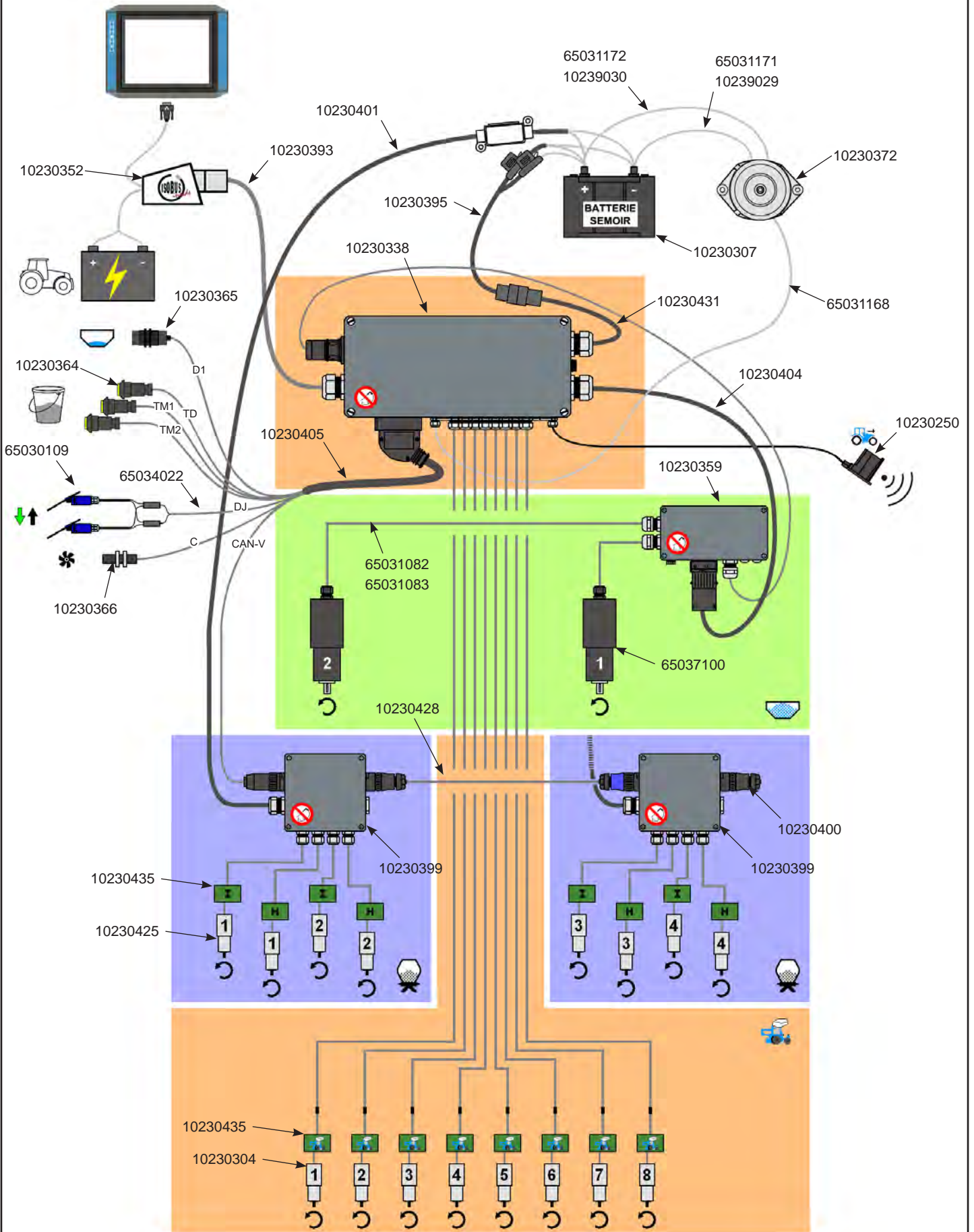



**APERÇU GÉNÉRAL - ARCHITECTURE FEP**  
**PERSPECTIVA GENERAL - ARQUITECTURA FEP**

**OVERVIEW - FEP ARCHITECTURE**  
**PANORAMICA GENERALE - ARCHITETTURA FEP**

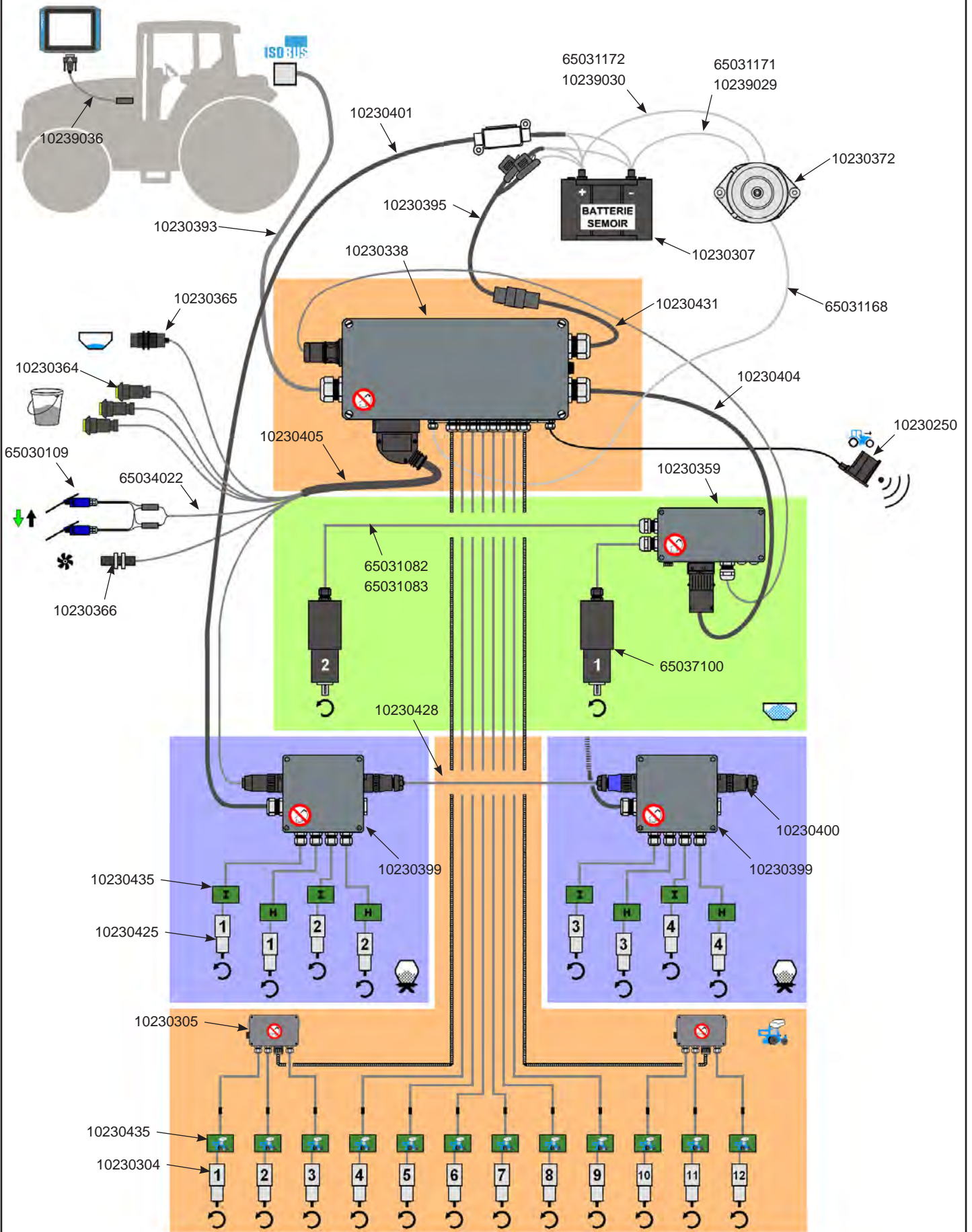

			
① - 10230399	② - 10230401	③ - 10230428	④ - 10230400
			
⑤ - 10230359	⑥ - 10230404	⑦ - 65037100	⑧ - 65031082 / 65031083
			
⑨ - 10230405	⑩ - 65030109	⑪ - 65034022	⑫ - 10230364
			
⑬ - 10230366	⑭ - 10230365	⑮ - 10230440 / 10230441	⑯ - 10230250
			
⑰ - 10230352	⑱ - 10230393	⑲ - 10239021	⑳ - 10239036
			
㉑ - 10230307	㉒ - 10230372	㉓ - 65031172 / 65031171	㉔ - 65031168
			
㉕ - 10230338	㉖ - 10230395	㉗ - 10239037 / 038 / 039	㉘ - 10230431
			
㉙ - P01510281	㉚ - P06160180	㉛ - P06040180	㉜ - 10230435
			
㉝ - 10230425	㉞ - 10230304	㉟ - 10230398	㊀ - 10230305
			
㊁ - 10239031	㊂ - 65032407	㊃ - 65032403 / 405 / 406	

### 3 - DESCRIPTION

#### Équipements électriques - semoir FEP

- ① - Boîtier ECV Microsem
- ② - Faisceau d'alimentation pour boîtier ECV Microsem
- ③ - Faisceau de connexion entre boîtier ECV Microsem
- ④ - Bouchon CAN pour boîtier ECV Microsem
- ⑤ - Boîtier MM2 Fertiliseur
- ⑥ - Faisceau d'alimentation pour boîtier MM2 Fertiliseur
- ⑦ - Moteur électrique entraînement fertiliseur
- ⑧ - Faisceau moteur pour Fertiliseur
- ⑨ - Faisceau accessoires
- ⑩ - Capteur de position basse / prise 2 voies
- ⑪ - Faisceau Y pour capteur de position
- ⑫ - Bouton d'étalonnage
- ⑬ - Capteur de rotation de turbine
- ⑭ - Capteur de fond de trémie
- ⑮ - Rallonge pour bouton d'étalonnage
- ⑯ - Radar de vitesse
- ⑰ - Faisceau ISOBUS côté tracteur
- ⑱ - Faisceau ISOBUS côté ECU principal
- ⑲ - Rallonge ISOBUS 4m
- ⑳ - Faisceau InCab «Muller»
- ㉑ - Batterie semoir
- ㉒ - Alternateur
- ㉓ - Faisceaux batterie / alternateur (+/-)
- ㉔ - Faisceau excitation pour alternateur
- ㉕ - Ensemble ECU principal 2.5G
- ㉖ - Faisceau duo-power côté batterie
- ㉗ - Rallonge pour faisceau duo-power
- ㉘ - Faisceau duo-power côté ECU principal
- ㉙ - Ensemble entraînement Microsem
- ㉚ - Ensemble entraînement NG Plus
- ㉛ - Ensemble entraînement MECA V4
- ㉜ - Carte électronique ECU moteur
- ㉝ - Moteur d'entraînement pour Microsem
- ㉞ - Moteur d'entraînement pour NG Plus
- ㉟ - Moteur d'entraînement pour MECA V4
- ㊱ - Boîtier de jonction
- ㊲ - Faisceau codeur pour moteur
- ㊳ - Faisceau ECU moteur côté boîtier
- ㊴ - Faisceau ECU moteur côté ECU principal

### 3 - DESCRIPCIÓN

#### Equipos eléctricos - sembradora FEP

- ① - Caja ECV Microsem
- ② - Cables de alimentación para caja ECV Microsem
- ③ - Cables de conexión entre caja ECV Microsem
- ④ - Tapón CAN para caja ECV Microsem
- ⑤ - Caja MM2 Fertilizador
- ⑥ - Cables de alimentación para caja MM2 Fertilizador
- ⑦ - Motor eléctrico transmisión fertilizador
- ⑧ - Cables del motor para Fertilizador
- ⑨ - Cables accesorios
- ⑩ - Captador de posición baja / toma 2 vías
- ⑪ - Cables Y para captador de posición
- ⑫ - Botón de calibrado
- ⑬ - Captador de giro de turbina
- ⑭ - Captador de fondo de tolva
- ⑮ - Alargador para botón de calibrado
- ⑯ - Radar de velocidad
- ⑰ - Cables ISOBUS lado tractor
- ⑱ - Cables ISOBUS lado ECU principal
- ⑲ - Alargador ISOBUS 4m
- ⑳ - Cables InCab «Muller»
- ㉑ - Batería sembradora
- ㉒ - Alternador
- ㉓ - Cables batería / alternador (+/-)
- ㉔ - Cables excitación para alternador
- ㉕ - Conjunto ECU principal 2.5G
- ㉖ - Cables duo-power lado batería
- ㉗ - Alargador para Cables duo-power
- ㉘ - Cables duo-power lado ECU principal
- ㉙ - Conjunto transmisión Microsem
- ㉚ - Conjunto transmisión NG Plus
- ㉛ - Conjunto transmisión MECA V4
- ㉜ - Tarjeta electrónica ECU motor
- ㉝ - Motor de transmisión para Microsem
- ㉞ - Motor de transmisión para NG Plus
- ㉟ - Motor de transmisión para MECA V4
- ㊱ - Caja de conexiones
- ㊲ - Cables codificador para motor
- ㊳ - Cables ECU motor lado caja
- ㊴ - Cables ECU motor lado ECU principal

### 3 - DESCRIPTION

#### FEP planter - electrical equipment

- ① - Microsem ECV unit
- ② - Supply harness for Microsem ECV unit
- ③ - Connection harness between Microsem ECV units
- ④ - CAN stopper plug for Microsem ECV unit
- ⑤ - Fertiliser placement unit MM2 unit
- ⑥ - Supply harness for fertiliser placement MM2 unit
- ⑦ - Fertilizer placement unit drive electric motor
- ⑧ - Motor harness for fertilizer placement unit
- ⑨ - Accessories harness
- ⑩ - Low position sensor / 2-way plug
- ⑪ - Y harness for position sensor
- ⑫ - Calibration button
- ⑬ - Turbine rotation sensor
- ⑭ - Hopper base sensor
- ⑮ - Extension lead for calibration button
- ⑯ - Speed radar
- ⑰ - Tractor side ISOBUS harness
- ⑱ - Main ECU side ISOBUS harness
- ⑲ - 4m ISOBUS extension lead
- ⑳ - "Muller" InCab harness
- ㉑ - Planter battery
- ㉒ - Alternator
- ㉓ - (+/-) alternator / battery harnesses
- ㉔ - Exciter harness for alternator
- ㉕ - 2.5G main ECU unit
- ㉖ - Battery side duo-power harness
- ㉗ - Extension lead for duo-power harness
- ㉘ - Main ECU side duo-power harness
- ㉙ - Microsem drive unit
- ㉚ - NG Plus drive unit
- ㉛ - MECA V4 drive unit
- ㉜ - Motor ECU electronic board
- ㉝ - Drive motor for Microsem
- ㉞ - Drive motor for NG Plus
- ㉟ - Drive motor for MECA V4
- ㊱ - Junction box
- ㊲ - Encoder harness for motor
- ㊳ - Unit side motor ECU harness
- ㊴ - Main ECU side motor ECU harness

### 3 - DESCRIZIONE

#### Impianti elettrici - seminatrice FEP

- ① - Scatola ECV Microsem
- ② - Fascio alimentazione per scatola ECV Microsem
- ③ - Fascio di collegamento tra scatola ECV Microsem
- ④ - Tappo CAN per scatola ECV Microsem
- ⑤ - Scatola MM2 Fertilizzatore
- ⑥ - Fascio alimentazione per scatola MM2 Fertilizzatore
- ⑦ - Motore elettrico azionamento Fertilizzatore
- ⑧ - Fascio motore per Fertilizzatore
- ⑨ - Fascio accessori
- ⑩ - Sensore di posizione bassa/presa 2 vie
- ⑪ - Fascio Y per sensore di posizione
- ⑫ - Pulsante di taratura
- ⑬ - Sensore di rotazione di turbina
- ⑭ - Sensore di fondo di tramoggia
- ⑮ - Prolunga per pulsante di taratura
- ⑯ - Radar di velocità
- ⑰ - Fascio ISOBUS lato trattore
- ⑱ - Fascio ISOBUS lato ECU principale
- ⑲ - Prolunga ISOBUS 4m
- ⑳ - Fascio InCab «Muller»
- ㉑ - Batteria seminatrice
- ㉒ - Alternatore
- ㉓ - Fascio batteria/alternatore (+/-)
- ㉔ - Fascio eccitazione per alternatore
- ㉕ - Assieme ECU principale 2.5G
- ㉖ - Fascio duo-power lato batteria
- ㉗ - Prolunga per fascio duo-power
- ㉘ - Fascio duo-power lato ECU principale
- ㉙ - Assieme azionamento Microsem
- ㉚ - Assieme azionamento NG Plus
- ㉛ - Assieme azionamento MECA V4
- ㉜ - Scheda elettronica ECU motore
- ㉝ - Motore di azionamento per Microsem
- ㉞ - Motore di azionamento per NG Plus
- ㉟ - Motore di azionamento per MECA V4
- ㊱ - Scatola di giunzione
- ㊲ - Fascio encoder per motore
- ㊳ - Fascio ECU motore lato scatola
- ㊴ - Fascio ECU motore lato ECU principale



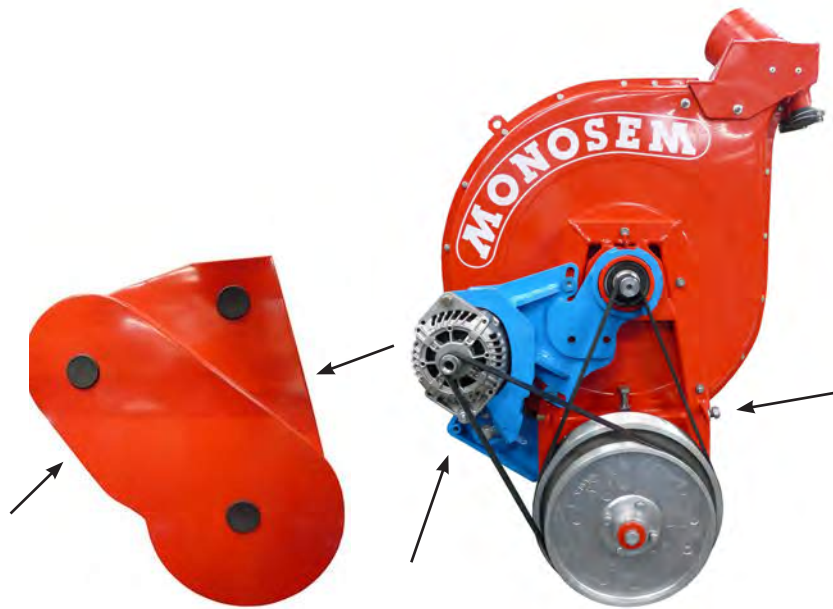

Fig.1

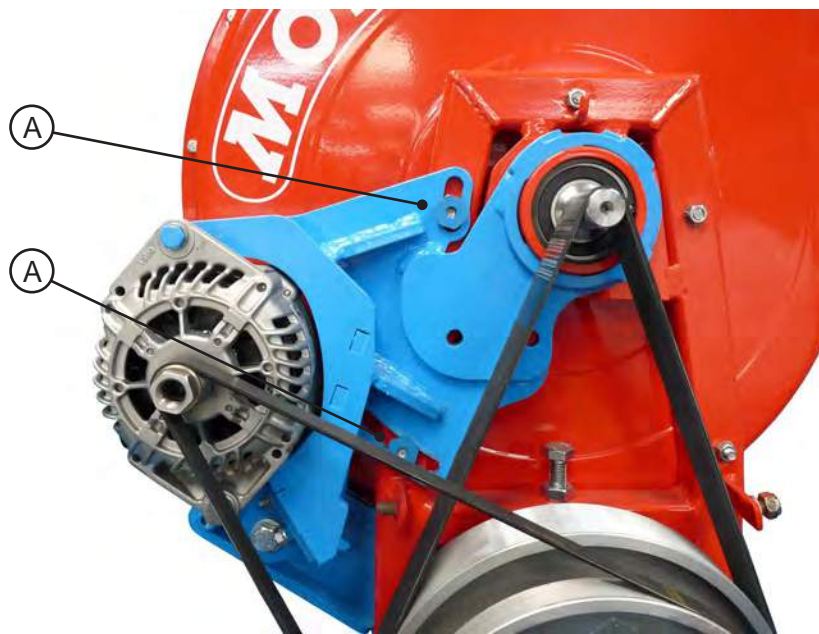

Fig.2

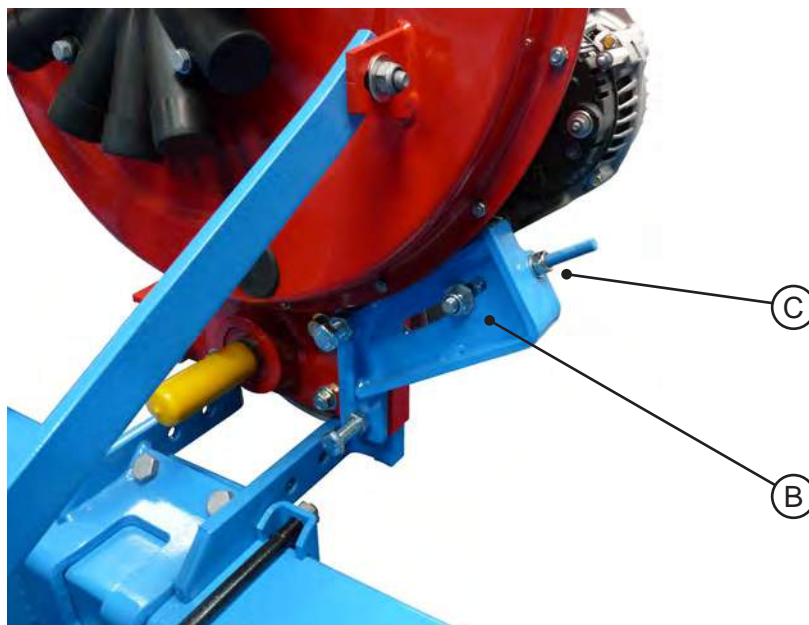

Fig.3

## 4 - MONTAGE ET RÉGLAGE COURROIE ALTERNATEUR

### ► Fixation de l'alternateur :

- Mise en place de l'alternateur.
- Fixation du carter (fig. 1).

**Avant chaque campagne, vérifier le serrage des vis (A, B & C - fig. 2 et 3).**

### ► Réglage tension de courroie alternateur :

- Enlever le carter de protection des courroies (fig. 1).
- Desserrer les deux écrous arrière (A - fig. 2)
- Desserrer l'écrou avant (B - fig. 3)
- Avec une clé, serrer ou desserrer l'écrou de réglage (C - fig. 3) afin d'obtenir la tension nécessaire au bon fonctionnement (137 Hz).
- Une fois la tension de courroie réglée, resserrer l'écrou avant et les deux écrous arrière.

### ► Nettoyage de l'alternateur :

Lors de la remise du semoir pour l'hiver, il est important de vérifier visuellement la propreté de l'alternateur, en général un bon coup de soufflette suffit pour son entretien.

Durant la saison, suivant les conditions de semis (Ex. en condition poussiéreuse, vérifier la propreté de l'alternateur, une fois encore, un bon coup de soufflette suffit pour son entretien. Si l'encrassement est important, renouveler l'opération autant que nécessaire.

## 4 - ALTERNATOR BELT ASSEMBLY AND SETTING

### ► Fastening the alternator:

- Putting in place the alternator.
- Fastening the casing (fig. 1).

**Before each season, check that the screws are tight (A, B & C fig 2 and 3).**

### ► Setting the tension of the alternator belt:

- Remove the belt's protective casing (fig. 1).
- Unscrew the two rear nuts (A - fig. 2)
- Unscrew the front nut (B - fig. 3)
- With a wrench, screw or unscrew the adjusting nut (C - fig. 3) in order to obtain the tension required for correct operation (137 Hz).
- Once the tension of the belt has been set, tighten the front nut and the two rear nuts.

### ► Cleaning the alternator:

When storing the planter for winter, it is important to visually check the cleanliness of the alternator, generally a good blow with the bellows is sufficient for its maintenance.

During the season, depending on the seeding conditions (eg in dusty conditions, check the cleanliness of the alternator, once again a good blow with the bellows is enough for its maintenance.) If the fouling is important, repeat the operation as often as necessary.

## 4 - MONTAJE Y AJUSTE DE LA CORREA DEL ALTERNADOR

### ► Fijación del alternador:

- Colocación del alternador.
- Fijación del cárter (fig. 1).

**Antes de cada campaña, comprobar el apriete de los tornillos (A, B & C - fig. 2 y 3).**

### ► Ajuste de la tensión de la correa del alternador:

- Quitar el cárter de protección de las correas (fig. 1).
- Aflojar las dos tuercas traseras (A - fig. 2)
- Aflojar la tuerca delantera (B - fig. 3)
- Con una llave, apretar o aflojar la tuerca de ajuste (C - fig. 3) para obtener la tensión necesaria para el buen funcionamiento (137 Hz).
- Una vez ajustada la tensión de la correa, apretar la tuerca delantera y las dos tuercas traseras.

### ► Limpieza del alternador:

Quando se guarda la sembradora al llegar el invierno, es importante comprobar visualmente el estado de limpieza del alternador; en general basta con limpiar bien con la pistola de aire comprimido para su mantenimiento.

Durante la temporada, según las condiciones de la siembra (por ej.: en condiciones de mucho polvo), comprobar si está limpio el alternador. De nuevo, basta con limpiar bien con la pistola de aire comprimido para su mantenimiento. Si está muy sucio, repetir la operación las veces que sea necesario.

## 4 - MONTAGGIO E REGOLAZIONE DELLA CINGHIA DELL'ALTERNATORE

### ► Fissaggio dell'alternatore:

- Posizionamento dell'alternatore.
- Fissaggio del carter (fig. 1).

**Prima di ogni campagna, controllare il serraggio delle viti (A, B & C - fig. 2 e 3).**

### ► Regolazione tensione cinghia alternatore:

- Togliere il carter di protezione delle cinghie (fig. 1).
- Allentare i due dadi posteriori (A - fig. 2)
- Allentare il dado anteriore (B - fig. 3)
- Con una chiave, stringere o allentare il dado di regolazione (C - fig. 3) per ottenere la tensione necessaria al corretto funzionamento (137 Hz).
- Una volta regolata la tensione, allentare il dado anteriore e i due dadi posteriori.

### ► Pulizia dell'alternatore:

Durante il rimessaggio della seminatrice per l'inverno, è importante controllare visivamente che l'alternatore sia pulito, in genere un colpo forte di soffiato basta a pulirlo.

Durante la stagione, a seconda delle condizioni di semina (ad esempio in presenza di polvere), controllare la pulizia dell'alternatore, ancora una volta, un colpo forte di soffiato basta a pulirlo. Se le incrostazioni sono notevoli, ripetere l'operazione tante volte quante necessario.

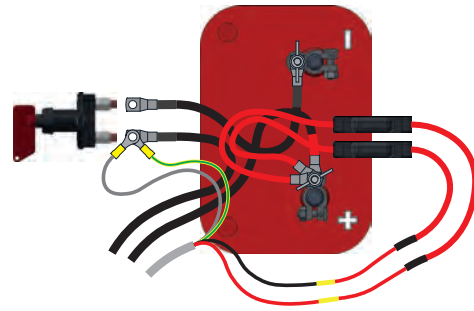

ON



OFF



OUT



Voltage  
 $\leq 10,5V$



Voltage  
 $\leq 10,5V$



Voltage  
 $\geq 10,5V$

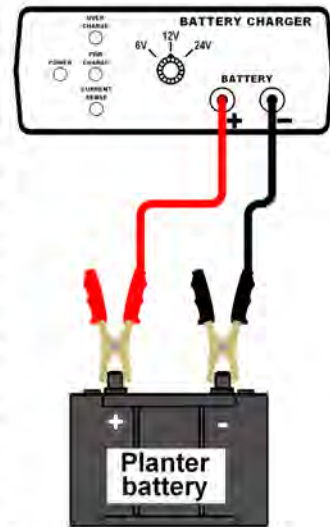
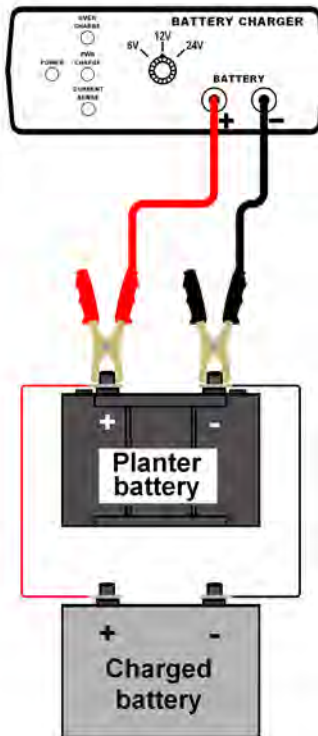
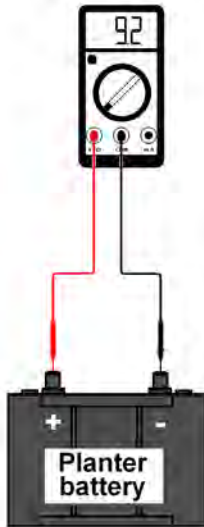



## 5 - MONTAGE ET ENTRETIEN DE LA BATTERIE

### ► Montage de la batterie OPTIMA :

Un support avec carter permet de protéger la batterie de la poussière et de l'humidité.

### ► Utilisation du coupe-circuit :

Permet de couper le circuit électrique afin d'éviter les pertes de courant et ainsi de décharger de la batterie.

ON : Le circuit électrique est alimenté par la batterie.

OFF : Coupe l'alimentation de la batterie.

OUT : Permet de retirer la clé de réglage (!\ Risque de perte).

### ► Recharge de la batterie OPTIMA :

Lors de la vérification de la tension, si celle-ci est inférieure à 10,5V, effectuer la recharge avec un chargeur de batterie à recharge lente.

### ► Hivernage de la batterie OPTIMA :

Lors de la période hivernale, débranchez la batterie du semoir et stockez-la dans un endroit sec et frais. Cela empêchera sa décharge par les consommations électriques basses. Procédez toujours à un rechargement complet à l'aide d'un chargeur de batterie avant de procéder au stockage, puis vérifiez la tension de la batterie tous les trois à six mois. Rechargez-la si celle-ci est inférieure à 12,4 V.

Il est possible également d'utiliser un chargeur branché en continu sur la batterie pour le maintien en charge durant la période hivernale.

## 5 - ASSEMBLING AND MAINTAINING THE BATTERY

### ► Installing the OPTIMA battery:

A support with casing protects the battery from dust and moisture.

### ► Use of the cut-off switch:

Allows disconnection of the electric circuit to prevent loss of current and thus battery discharge.

ON: The battery is supplying power to the electric circuit.

OFF: The battery power supply is disconnected.

OUT: Allows removal of the adjusting key (!\ Risk of loss).

### ► Recharging the OPTIMA battery:

When checking the voltage, if it is lower than 10.5V, recharge with a slow-charge battery charger.

### ► Storing the OPTIMA battery over the winter period:

Over the winter period, unplug the battery from the planter and store it in a cool, dry place. This will prevent it from discharging owing to low power consumption. Always fully recharge with a battery charger before storing, then check the battery voltage every three – six months. Recharge it if it is below 12.4 V.

It is also possible to use a continuously connected charger on the battery to keep it charged over the winter period.

## 5 - MONTAJE Y MANTENIMIENTO DE LA BATERÍA

### ► Montaje de la batería OPTIMA:

La batería va protegida del polvo y de la humedad mediante un soporte con cárter.

### ► Uso del cortocircuito:

Permite cortar el circuito eléctrico para evitar las pérdidas de corriente y así descargar la batería.

ON: el circuito eléctrico es alimentado por la batería.

OFF: Corta la alimentación de la batería.

OUT: Permite retirar la llave de ajuste (!\ Riesgo de pérdida).

### ► Recarga de la batería OPTIMA:

Si al comprobar la tensión, ésta es inferior a 10,5V, efectuar la recarga con un cargador de batería de recarga lenta.

### ► La batería OPTIMA durante el invierno:

Durante el periodo invernal, desconectar la batería de la sembradora y guardarla en un lugar seco y fresco. De este modo se impedirá que se descargue por consumos eléctricos bajos. Proceder siempre a una recarga completa con un cargador de batería antes de guardarla. Comprobar la tensión de la batería cada tres o seis meses. Recargarla si es inferior a 12,4 V.

Asimismo, se puede utilizar un cargador conectado en continuo a la batería para mantenerlo en carga durante el periodo invernal.

## 5 - MONTAGGIO E MANUTENZIONE DELLA BATTERIA

### ► Montaggio della batteria OPTIMA:

Un supporto con carter consente di proteggere la batteria dalla polvere e dall'umidità.

### ► Uso della valvola di sicurezza:

Consente di staccare il circuito elettrico per evitare le perdite di corrente e di scaricare quindi la batteria.

ON: Il circuito elettrico è alimentato dalla batteria.

OFF: Stacca l'alimentazione della batteria.

OUT: Consente di rimuovere la chiave di regolazione (!\ Rischio di perdita).

### ► Ricarica della batteria OPTIMA:

Durante la verifica della tensione, se è inferiore a 10,5V, effettuare la ricarica con un caricabatteria a ricarica lenta.

### ► Rimessaggio invernale della batteria OPTIMA:

Durante il periodo invernale, staccare la batteria della seminatrice e immagazzinarla in un posto asciutto e fresco. Ciò impedirà che si scarichi per via dei bassi consumi elettrici. Eseguire sempre una ricarica completa con un caricabatteria, prima di procedere all'immagazzinaggio, controllare quindi la tensione della batteria ogni tre - sei mesi. Ricaricarla se è inferiore a 12,4 V.

Si può inoltre utilizzare un caricatore allacciato in continuo alla batteria per il mantenimento in carica durante il periodo invernale.

①



②



③



④

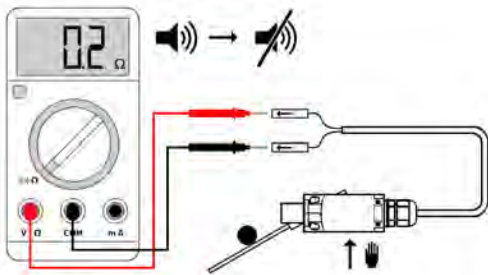

**MONOSHOX**  
**NG Plus**  
**M**



⑤



⑥

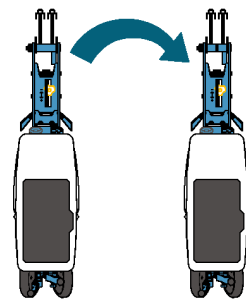

⑦



## 6 - MONTAGE ET RÉGLAGE DES CAPTEURS « fin de course » Semoirs NG Plus ME / NG PLUS 4E / NX ME

### ► Montage :

- ①- Semoir baissé, inverser le sens de la cale sur les éléments avec capteur comme ci-dessus.
- ②- Positionner un plat d'épaisseur 5mm, puis relever le semoir.
- ③- Semoir relevé, effectuer le montage du support sur la tête de l'élément.  
Positionner également le capteur sur son support sans le serrer.

### ► Réglage du capteur :

- ④- Semoir relevé, utiliser un multimètre sur la fonction "Ohm".
  - ☞ Établir la connexion entre les fils du multimètre et les connecteurs du capteur.
  - ☞ Faire glisser le capteur vers le haut jusqu'à l'arrêt du bip sonore du multimètre "le signal ne passe plus".
  - ☞ Maintenir la position du capteur puis serrer le capteur.
- ⑤- Effectuer le passage du fil et brancher les connecteurs.
  - ☞ Poser le semoir au sol pour retirer la cale de réglage d'ép.5mm.
- ⑥- Faire la même manipulation sur l'autre élément.

### ► Position de l'élément :

- ⑦- Vérifier avec la console le fonctionnement des capteurs.
  - ☞ Effectuer des manœuvres de montées et descentes du semoir pour la vérification.
  - ☞ Le symbole à l'écran donne la position du semoir (relevé ou baissé).

## 6 - ASSEMBLING AND SETTING THE "end of travel" SENSORS NG Plus ME / NG PLUS 4E / NX ME planters

### ► Assembly :

- ①- Planter down in work position, rotate the unit stop like on the picture above.
- ②- Position a plate 5 mm thick and lift the planter.
- ③- Planter up, fit the bracket on the unit clamp face.  
Fit the switch on the bracket but don't tight the screws, let it free.

### ► Sensor adjustment :

- ④- Planter up, use a ohmmeter to adjust the switch.
  - ☞ Put the electrode on implement switch connectors. The bip sound,
  - ☞ Slide the switch till the sound alarm stop.
  - ☞ Hold the switch and tight the screws.
- ⑤- Plug the connectors and tie the wires.
  - ☞ Lower the planter and remove the adjustment shim
- ⑥- Repeat the same steps for the other switch.

### ► Position of the metering unit :

- ⑦- Check on the terminal the switches functionalities.
  - ☞ Test the implement switches adjustment by lifting and lowering the planter several times.
  - ☞ The icon on the terminal screen shows the position.

## 6 - MONTAJE Y AJUSTE DE LOS CAPTADORES «final de carrera» Sembradoras NG Plus ME / NG PLUS 4E / NX ME

### ► Montaje:

- ①- Con la sembradora bajada, invertir el sentido del calzo en los elementos con captador como se indica más arriba.
- ②- Colocar un plato de 5 mm de espesor, y levantar la sembradora.
- ③- Con la sembradora levantada, efectuar el montaje del soporte sobre la cabeza del elemento.  
Colocar igualmente el captador sobre su soporte sin presionarlo.

### ► Ajuste del captador:

- ④- Con la sembradora levantada, utilizar un tester en la función "Ohm".
  - ☞ Establecer la conexión entre los cables del tester y los conectores del captador.
  - ☞ Desplazar el captador hacia arriba hasta que pare el bip sonoro del tester "la señal ya no pasa".
  - ☞ Mantener la posición del captador y después apretar el captador.
- ⑤- Efectuar el paso del cable y conectarlo a los conectores.
  - ☞ Dejar la sembradora en el suelo para retirar el calzo de ajuste de 5 mm de espesor.
- ⑥- Hacer la misma operación con el otro elemento.

### ► Posición del elemento:

- ⑦- Verificar con la consola el funcionamiento de los captadores.
  - ☞ Efectuar maniobras de subidas y bajadas de la sembradora para la verificación.
  - ☞ El símbolo de la pantalla muestra la posición de la sembradora (levantada o bajada).

## 6 - MONTAGGIO E REGOLAZIONE DEI SENSORI «fine corsa» Seminatrici NG Plus ME / NG PLUS 4E / NX ME

### ► Montaggio:

- ①- Seminatrice abbassata, invertire il senso del cuneo sugli elementi con il sensore, come sopra.
- ②- Posizionare un piano di uno spessore di 5mm, quindi sollevare la seminatrice.
- ③- Seminatrice alzata, montare il supporto sulla testa dell'elemento.  
Posizionare anche il sensore sul suo supporto senza stringerlo.

### ► Regolazione del sensore:

- ④- Seminatrice alzata, utilizzare un multimetro sulla funzione "Ohm".
  - ☞ Stabilire il collegamento tra i fili del multimetro e i connettori del sensore.
  - ☞ Fare scorrere il sensore verso l'alto fino all'arresto del segnale acustico del multimetro, "il segnale non passa più".
  - ☐☐Mantenere la posizione del sensore, quindi stringerlo.
- ⑤- Effettuare il passaggio del filo e allacciare i connettori.
  - ☞ Posare la seminatrice a terra per togliere il cuneo di regolazione spesso 5mm.
  - Hacer la misma operación con el otro elemento.
  - Procedere allo stesso modo per l'altro elemento.

### ► Posizione dell'elemento:

- ⑦- Controllare con la consola il funzionamento dei sensori.
  - ☞ Effettuare manovre di salite e di discese della seminatrice per la verifica.
  - ☞ Il simbolo sul display indica la posizione della seminatrice (sollevata o abbassata).



①



②



③

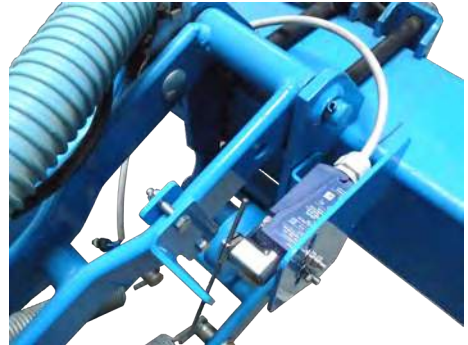
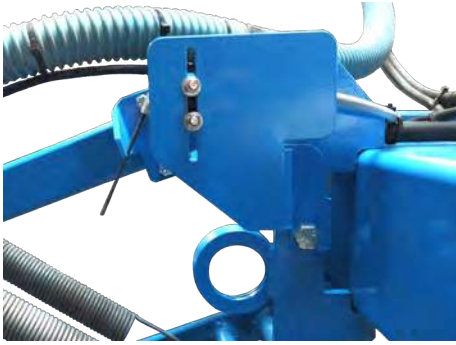

④

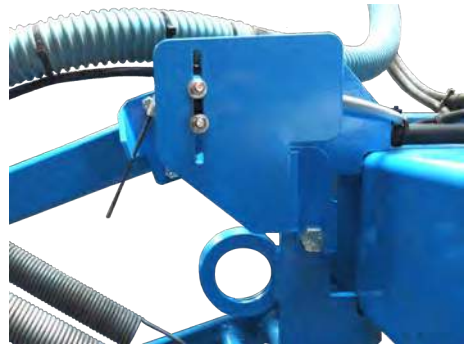
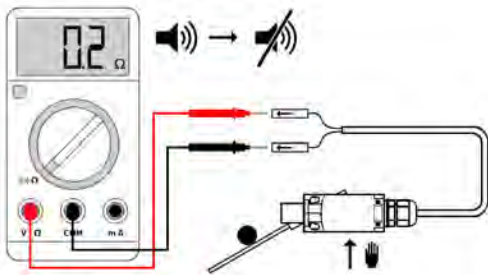

⑤



⑥

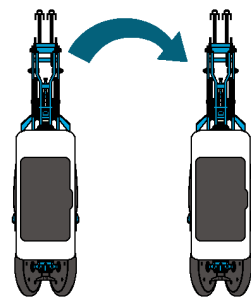

⑦

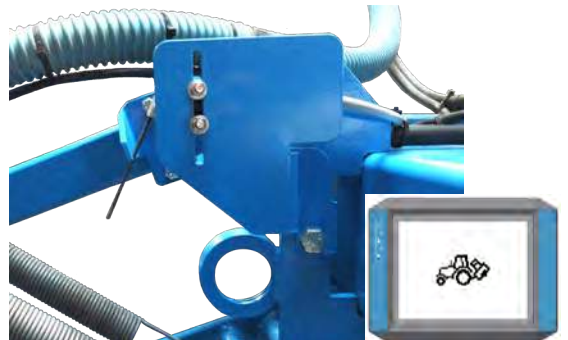

①



②



③

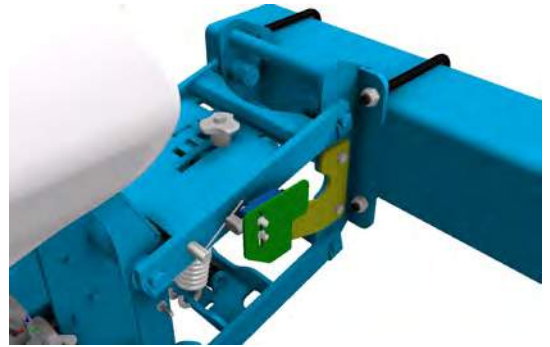
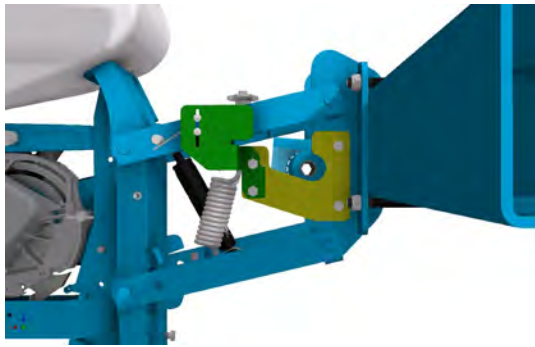

④

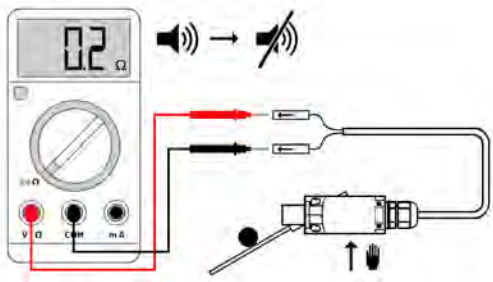

MONOSHOX  
NX  
M

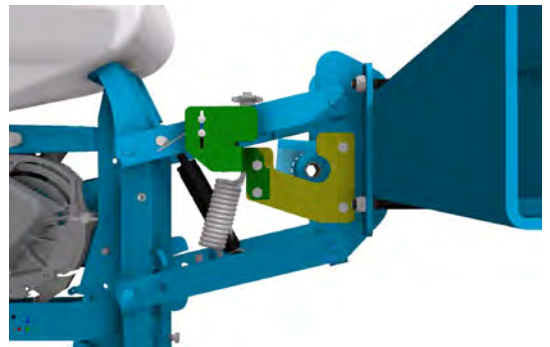

⑤



⑥

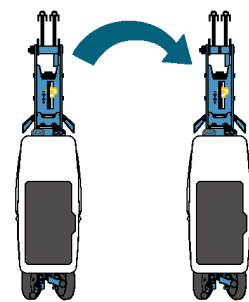

⑦

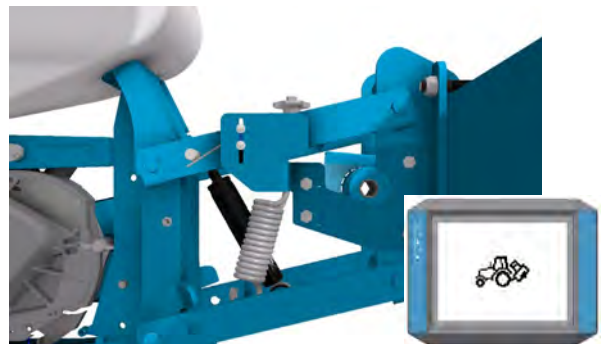
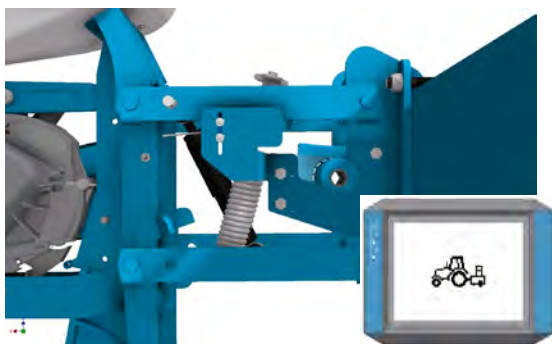



①



②

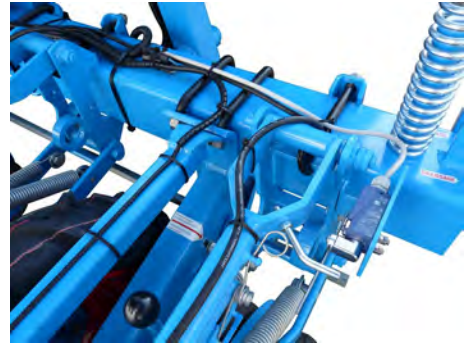

③

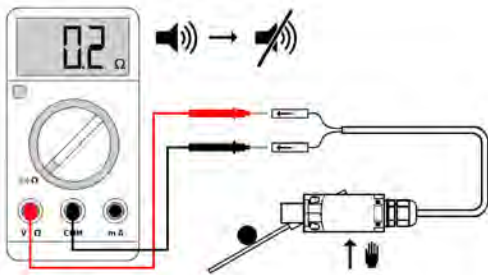

④

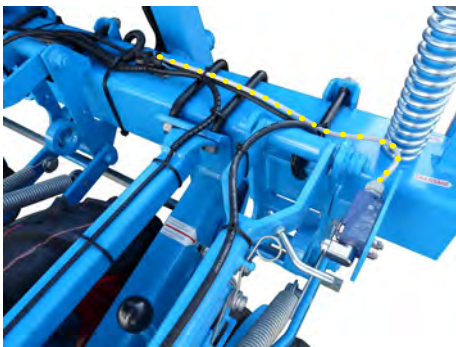

⑤

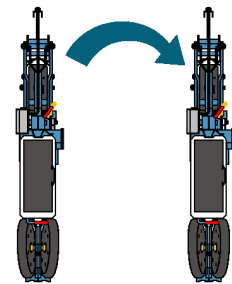

⑥

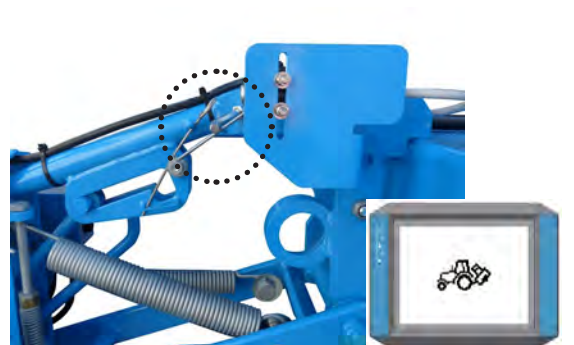
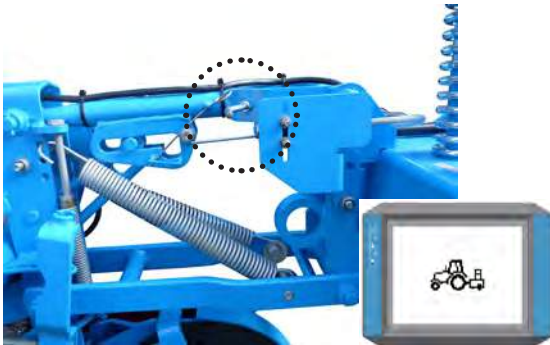



## MONTAGE ET RÉGLAGE DES CAPTEURS

### « fin de course »

#### Semoir MECA V4E

##### ► Montage :

①- Semoir baissé, positionner un rond de calage Ø 8mm, puis relever le semoir.

②- Semoir relevé, effectuer le montage du support sur la tête de l'élément.

Positionner également le capteur sur son support sans le serrer.

##### ► Réglage du capteur:

③- Semoir relevé, utiliser un multimètre sur la fonction "Ohm".

☞ Établir la connexion entre les fils du multimètre et les connecteurs du capteur.

☞ Faire glisser le capteur vers le haut jusqu'à l'arrêt du bip sonore du multimètre "le signal ne passe plus".

☞ Maintenir la position du capteur puis serrer le capteur.

④- Effectuer le passage du fil et brancher les connecteurs.

☞ Poser le semoir au sol pour retirer le rond de calage Ø8mm.

⑤- Faire la même manipulation sur l'autre élément.

##### ► Position de l'élément :

⑥- Vérifier avec la console le fonctionnement des capteurs.

☞ Effectuer des manœuvres de montées et descentes du semoir pour la vérification.

☞ Le symbole à l'écran donne la position du semoir (relevé ou baissé).

## ASSEMBLING AND SETTING

### THE "end of travel" SENSORS

#### MECA V4E planter

##### ► Assembly :

①- Planter in a lowered position, fit a wedging spacer diam. 8mm and then lift up the planter.

②- Planter up, fit the bracket on the unit clamp face.

Fit the switch on the bracket but don't tight the screws, let it free.

##### ► Sensor adjustment :

③- Planter up, use a ohmmeter to adjust the switch.

☞ Put the electrode on implement switch connectors. The bip sound,

☞ Slide the switch till the sound alarm stop.

☞ Hold the switch and tight the screws.

④- Plug the connectors and tie the wires.

☞ Position the planter on the ground in order to remove the wedging spacer diam. 8mm.

⑤- Repeat the same steps for the other switch.

##### ► Position of the metering unit :

⑥- Check on the terminal the switches functionalities.

☞ Test the implement switches adjustment by lifting and lowering the planter several times.

☞ The icon on the terminal screen shows the position.

## MONTAJE Y AJUSTE DE LOS CAPTADORES «final de carrera»

### Sembradora MECA V4E

##### ► Montaje:

①- Con la sembradora bajada, posicionar una ronda Ø 8mm, y levantar la sembradora.

②- Con la sembradora levantada, efectuar el montaje del soporte sobre la cabeza del elemento.

Colocar igualmente el captador sobre su soporte sin presionarlo.

##### ► Ajuste del captador:

③- Con la sembradora levantada, utilizar un tester en la función "Ohm".

☞ Establecer la conexión entre los cables del tester y los conectores del captador.

☞ Desplazar el captador hacia arriba hasta que pare el bip sonoro del tester "la señal ya no pasa".

☞ Mantener la posición del captador y después apretar el captador.

④- Efectuar el paso del cable y conectarlo a los conectores.

☞ Dejar la sembradora en el suelo para quitar el redondo Ø8mm.

⑤- Hacer la misma operación con el otro elemento.

##### ► Posición del elemento:

⑥- Verificar con la consola el funcionamiento de los captadores.

☞ Efectuar maniobras de subidas y bajadas de la sembradora para la verificación.

☞ El símbolo de la pantalla muestra la posición de la sembradora (levantada o bajada).

## MONTAGGIO E REGOLAZIONE DEI SENSORI «fine corsa»

### Seminatrice MECA V4E

##### ► Montaggio:

①- Seminatrice abbassata, posizionare un tondo Ø 8mm, quindi sollevare la seminatrice.

②- Seminatrice alzata, montare il supporto sulla testa dell'elemento.

Posizionare anche il sensore sul suo supporto senza stringerlo.

##### ► Regolazione del sensore:

③- Seminatrice alzata, utilizzare un multimetro sulla funzione "Ohm".

☞ Stabilire il collegamento tra i fili del multimetro e i connettori del sensore.

☞ Fare scorrere il sensore verso l'alto fino all'arresto del segnale acustico del multimetro, "il segnale non passa più".

☞ Mantenere la posizione del sensore, quindi stringerlo.

④- Effettuare il passaggio del filo e allacciare i connettori.

☞ Posare la seminatrice a terra rimuovere il rotondo Ø8mm.

⑤- Procedere allo stesso modo per l'altro elemento.





##### ► Posizione dell'elemento:





⑥- Controllare con la consola il funzionamento dei sensori.





☞ Effettuare manovre di salite e di discese della seminatrice per la verifica.

☞ Il simbolo sul display indica la posizione della seminatrice (sollevata o abbassata).



**7 - VITESSE DE ROTATION DU DISQUE DE DISTRIBUTION EN tr/min**  
**7 - ROTATION SPEED OF THE METERING DISK IN revolutions/min**



		  cm																		
		3	4	5	6	7	8	9	10	11	12	13	14	15	16	17	18	19	20	
 km/h	3	-	-	55.5	46.2	39.6	34.7	30.8	27.7	25.2	23.1	21.3	19.8	18.5	17.3	16.3	15.4	14.6	13.8	
	4	-	-	-	-	52.9	46.2	41.1	37.0	33.6	30.8	28.4	26.4	24.6	23.1	21.7	20.5	19.4	18.5	
	5	-	-	-	-	-	-	-	51.4	46.2	42.0	38.5	35.6	33.0	30.8	28.9	27.2	25.7	24.3	23.1
	6	-	-	-	-	-	-	-	-	55.5	50.5	46.2	42.7	39.6	37.0	34.7	32.6	30.8	29.2	27.7
	7	-	-	-	-	-	-	-	-	-	-	54.0	49.8	46.2	43.2	40.5	38.1	36.0	34.1	32.4
	8	-	-	-	-	-	-	-	-	-	-	-	-	52.9	49.3	46.2	43.5	41.1	38.9	37.0
	9	-	-	-	-	-	-	-	-	-	-	-	-	-	55.5	52.0	49.0	46.2	43.8	41.6
	10	-	-	-	-	-	-	-	-	-	-	-	-	-	-	-	54.4	51.4	48.7	46.2



		  cm																		
		3	4	5	6	7	8	9	10	11	12	13	14	15	16	17	18	19	20	
 km/h	3	-	52.0	41.6	34.7	29.7	26.0	23.1	20.8	18.9	17.3	16.0	14.8	13.8	13.0	12.2	11.5	10.9	10.4	
	4	-	-	55.5	46.2	39.6	34.7	30.8	27.7	25.2	23.1	21.3	19.8	18.5	17.3	16.3	15.4	14.6	13.8	
	5	-	-	-	-	49.6	43.4	38.5	34.7	31.5	28.9	26.7	24.8	23.1	21.7	20.4	19.2	18.2	17.3	
	6	-	-	-	-	-	52.0	46.2	41.6	37.8	34.7	32.0	29.7	27.7	26.0	24.5	23.1	21.9	20.8	
	7	-	-	-	-	-	-	-	54.0	48.6	44.1	40.5	37.3	34.7	32.4	30.3	28.5	27.0	25.5	24.3
	8	-	-	-	-	-	-	-	-	55.5	50.5	46.2	42.7	39.6	37.0	34.7	32.6	30.8	29.2	27.7
	9	-	-	-	-	-	-	-	-	-	-	52.0	48.0	44.6	41.6	39.0	36.7	34.7	32.8	31.2
	10	-	-	-	-	-	-	-	-	-	-	-	53.4	49.6	46.2	43.4	40.8	38.5	36.54	34.7

		  cm																	
		3	4	5	6	7	8	9	10	11	12	13	14	15	16	17	18	19	20
 km/h	3	55.5	41.6	33.3	27.7	23.8	20.8	18.5	16.6	15.1	13.8	12.8	11.9	11.1	10.4	9.8	9.2	8.7	8.3
	4	-	55.5	44.4	37.0	31.7	27.7	24.6	22.2	20.2	18.5	17.0	15.8	14.8	13.8	13.0	12.3	11.6	11.1
	5	-	-	55.5	46.2	39.6	34.7	30.8	27.7	25.2	23.1	21.3	19.8	18.5	17.3	16.3	15.4	14.6	13.8
	6	-	-	-	55.5	47.6	41.6	37.0	33.3	30.3	27.7	25.6	23.8	22.2	20.8	19.6	18.5	17.5	16.6
	7	-	-	-	-	55.5	48.6	43.2	38.8	35.3	32.4	29.9	27.7	25.9	24.3	22.8	21.6	20.4	19.4
	8	-	-	-	-	-	55.5	49.3	44.4	40.4	37.0	34.1	31.7	29.6	27.7	26.1	24.6	23.3	22.2
	9	-	-	-	-	-	-	55.5	50	45.4	41.6	38.4	35.7	33.3	31.25	29.4	27.7	26.3	25
	10	-	-	-	-	-	-	-	55.5	50.5	46.2	42.7	39.6	37.0	34.7	32.6	30.8	29.2	27.7

**7 – VELOCIDAD DE GIRO DEL DISCO DE DISTRIBUCIÓN EN rpm**  
**7 - VELOCITÀ DI ROTAZIONE DEL DISCO DI DISTRIBUZIONE IN giri/min**

		 																		
		3	4	5	6	7	8	9	10	11	12	13	14	15	16	17	18	19	20	
 km/h	<b>3</b>	46.2	34.7	27.7	23.1	19.8	17.3	15.4	13.8	12.6	11.5	10.6	9.9	9.2	8.6	8.1	7.7	7.3	6.9	
	<b>4</b>	-	46.2	37.0	30.8	26.4	23.1	20.5	18.5	16.8	15.4	14.2	13.2	12.3	11.5	10.8	10.2	9.7	9.2	
	<b>5</b>	-	-	46.2	38.5	33.0	28.9	25.7	23.1	21.0	19.2	17.8	16.5	15.4	14.4	13.6	12.8	12.1	11.5	
	<b>6</b>	-	-	-	55.5	46.2	39.6	34.7	30.8	27.7	25.2	23.1	21.3	19.8	18.5	17.3	16.3	15.4	14.6	13.8
	<b>7</b>	-	-	-	-	54.0	46.2	40.5	36.0	32.4	29.4	27.0	24.9	23.1	21.6	20.2	19.0	18.0	17.0	16.2
	<b>8</b>	-	-	-	-	-	52.9	46.2	41.1	37.0	33.6	30.8	28.4	26.4	24.6	23.1	21.7	20.5	19.4	18.5
	<b>9</b>	-	-	-	-	-	-	52.0	46.2	41.6	37.8	34.7	32.0	29.7	27.7	26.0	24.5	23.1	21.9	20.8
	<b>10</b>	-	-	-	-	-	-	-	51.4	46.2	42.0	38.5	35.6	33.0	30.8	28.9	27.2	25.7	24.3	23.1

		 																		
		3	4	5	6	7	8	9	10	11	12	13	14	15	16	17	18	19	20	
 km/h	<b>3</b>	27.7	20.8	16.6	13.8	11.9	10.4	9.2	8.3	7.5	6.9	6.4	5.9	5.5	5.2	4.9	4.6	4.3	4.1	
	<b>4</b>	37.0	27.7	22.2	18.5	15.8	13.8	12.3	11.1	10.1	9.2	8.5	7.9	7.4	6.9	6.5	6.1	5.8	5.5	
	<b>5</b>	46.2	34.7	27.7	23.1	19.8	17.3	15.4	13.8	12.6	11.5	10.6	9.9	9.2	8.6	8.1	7.7	7.3	6.9	
	<b>6</b>	55.5	41.6	33.3	27.7	23.8	20.8	18.5	16.6	15.1	13.8	12.8	11.9	11.1	10.4	9.8	9.2	8.7	8.3	
	<b>7</b>	-	48.6	38.8	32.4	27.7	24.3	21.6	19.4	17.6	16.2	14.9	13.8	12.9	12.1	11.4	10.8	10.2	9.7	
	<b>8</b>	-	-	55.5	44.4	37.0	31.7	27.7	24.6	22.2	20.2	18.5	17.0	15.8	14.8	13.8	13.0	12.3	11.6	11.1
	<b>9</b>	-	-	-	50	41.6	35.7	31.2	27.7	25	22.7	20.8	19.2	17.8	16.6	15.6	14.7	13.8	13.1	12.5
	<b>10</b>	-	-	-	-	55.5	46.2	39.6	34.7	30.8	27.7	25.2	23.1	21.3	19.8	18.5	17.3	16.3	15.4	14.6

		 																		
		3	4	5	6	7	8	9	10	11	12	13	14	15	16	17	18	19	20	
 km/h	<b>3</b>	23.1	17.3	13.8	11.5	9.9	8.6	7.7	6.9	6.3	5.7	5.3	4.9	4.6	4.3	4.0	3.8	3.6	3.4	
	<b>4</b>	30.8	23.1	18.5	15.4	13.2	11.5	10.2	9.2	8.4	7.7	7.1	6.6	6.1	5.7	5.4	5.1	4.8	4.6	
	<b>5</b>	38.5	28.9	23.1	19.2	16.5	14.4	12.8	11.5	10.5	9.6	8.9	8.2	7.7	7.2	6.8	6.4	6.0	5.7	
	<b>6</b>	46.2	34.7	27.7	23.1	19.8	17.3	15.4	13.8	12.6	11.5	10.6	9.9	9.2	8.6	8.1	7.7	7.3	6.9	
	<b>7</b>	54.0	40.5	32.4	27.0	23.1	20.2	18.0	16.2	14.7	13.5	12.4	11.5	10.8	10.1	9.5	9.0	8.5	8.1	
	<b>8</b>	-	46.2	37.0	30.8	26.4	23.1	20.5	18.5	16.8	15.4	14.2	13.2	12.3	11.5	10.8	10.2	9.7	9.2	
	<b>9</b>	-	-	52.0	41.6	34.7	29.7	26.0	23.1	20.8	18.9	17.3	16.0	14.8	13.8	13.0	12.2	11.5	10.9	10.4
	<b>10</b>	-	-	-	46.2	38.5	33.0	28.9	25.7	23.1	21.0	19.2	17.8	16.5	15.4	14.4	13.6	12.8	12.1	11.5

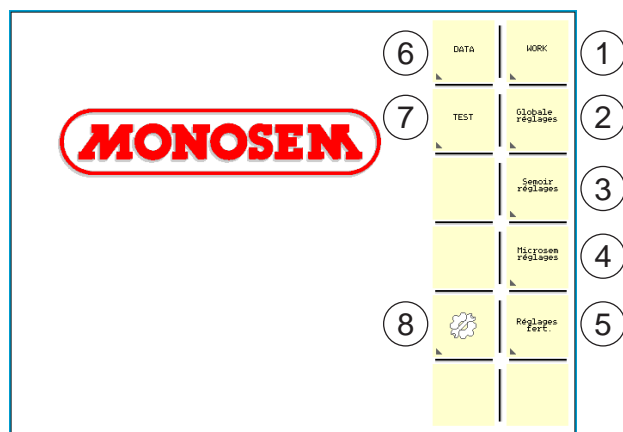
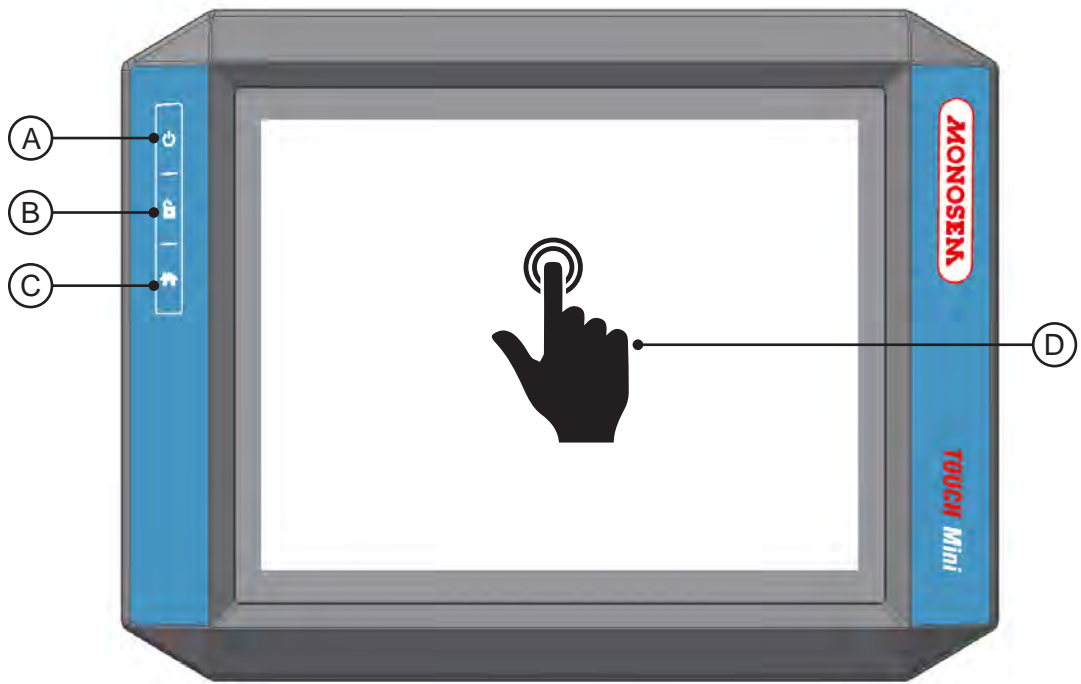

## 8 - DESCRIPTION ET UTILISATION DE LA CONSOLE

### ► Description de la console TOUCH mini :

- A - Touche marche / arrêt
- B - Capture d'écran si clé USB branchée
- C - Retour au menu d'accueil
- D - Écran d'affichage tactile

### ► Démarrage de la console :

Appuyer quelques secondes sur la touche marche / arrêt (A).  
Attendre jusqu'à ce que toutes les applications et tâches soient chargées.

### ► Mode gestion semoir :

- ①- Menu « WORK »
- ②- Menu « Réglages globaux »
- ③- Menu « Réglages du semoir »
- ④- Menu « Réglages du Microsem »
- ⑤- Menu « Réglages du fertiliseur »
- ⑥- Menu « DATA »
- ⑦- Menu « TEST »
- ⑧- Menu « Accès constructeur »

☞ Les menus et sous-menus sont indiqués par un petit coin noir dans le domaine de symbole. 

☞ Les autres champs de symboles activent une étape de travail spécifique. 

## 8 - DESCRIPTION AND USE OF THE CONSOLE

### ► Description of the console:

- A - On/off key
- B - Screen capture if USB key plugged in
- C - Back to the home menu
- D - Escape key

### ► Starting up the console:

Press and hold down the on / off (A) key for a few seconds.  
Wait until all the applications and tasks have loaded.

### ► Planter management mode:

- ①- "WORK" menu
- ②- "General settings" menu
- ③- "Planter settings" menu
- ④- "Microsem settings" menu
- ⑤- "Fertilizer placement unit settings" menu
- ⑥- "DATA" menu
- ⑦- "TEST" menu
- ⑧- "Manufacturer access" menu

☞ The menus and sub-menus are indicated by a small black wedge in the symbol area. 

☞ The other symbol fields activate a specific operating step. 

## 8 - DESCRIPCIÓN Y USO DE LA CONSOLA

### ► Descripción de la consola:

- A - Botón de marcha/parada
- B - Captura de pantalla si la llave USB está conectada.
- C - Vuelta al menú de inicio
- D - Pantalla táctil

### ► Arranque de la consola:

Pulsar durante unos segundos el botón de marcha/parada (A).  
Esperar a que se carguen todas las aplicaciones y tareas.

### ► Modo gestión de la sembradora:

- ①- Menú «WORK»
- ②- Menú «Ajustes globales»
- ③- Menú «Ajustes de la sembradora»
- ④- Menú «Ajustes de Microsem»
- ⑤- Menú «Ajustes del fertilizador»
- ⑥- Menú «DATA»
- ⑦- Menú «TEST»
- ⑧- Menú «Acceso fabricante»

☞ Los menús y sub-menús se indican con una pequeña cuña negra en el campo del símbolo. 

☞ Los demás campos de símbolos activan una etapa de trabajo específica. 

## 8 - DESCRIZIONE E UTILIZZO DELLA CONSOLE

### ► Descrizione della consola:

- A - Tasto On/Off
- B - Cattura dello schermo se chiave USB inserita.
- C - Ritorno al menu principale
- D - Display di visualizzazione tattile

### ► Avvio della consola:

Premere per alcuni secondi il tasto on/ off (A).  
Attendere finché tutte le applicazioni e i task non siano stati caricati.

### ► Modo di gestione seminatrice:

- ①- Menu «WORK»
- ②- Menu «Regolazioni globali»
- ③- Menu «Regolazioni della seminatrice»
- ④- Menu «Regolazioni del Microsem»
- ⑤- Menu «Regolazioni del fertilizzatore»
- ⑥- Menu «DATA»
- ⑦- Menu «TEST»
- ⑧- Menu «Accesso costruttore»

☞ I menu e i sottomenù sono indicati da un angolino nero nel campo del simbolo. 

☞ Gli altri campi di simboli attivano una tappa specifica di lavoro. 

# MENU WORK

WORK

The screenshot shows a control panel with the following elements:

- Top row: Tractor icon, 0.0 km/h, 5/8, and a gear icon.
- Second row: 0.00 ha, a gear icon with a slash, a gear icon with an upward arrow, and a STOP icon.
- Third row: 13.3 cm, a fan icon, and 0 rpm.
- Fourth row: Four vertical bars labeled 1, 2, 3, 4.
- Fifth row: A sum icon with 100.0 Mg/ha, a sum icon with 0.0 Mg/ha, and a green box icon with 0.0 Mg/ha.
- Sixth row: A blue box icon, a trapezoidal display showing 0.0 kg/ha, and a gear icon.
- Seventh row: A gear icon with a slash, a trapezoidal display showing 27.7 kg/ha, and a gear icon.
- Eighth row: A gear icon with a slash, a trapezoidal display showing 0.0 kg/ha, and a gear icon.
- Right side: A vertical column of icons including STOP, a gear, a bar chart, a bar chart with a plus sign, a bar chart with a minus sign, a bar chart with a plus sign, a bar chart with a minus sign, a bar chart with a plus sign, a bar chart with a minus sign, a bar chart with a plus sign, a bar chart with a minus sign, a bar chart with a plus sign, a bar chart with a minus sign.

The diagram shows the menu interface with numbered callouts:

- 1: Tractor icon
- 2: 0.00 ha
- 3: 1.9 cm
- 4: Four vertical bars (1, 2, 3, 4)
- 5: 5/8
- 6: Gear icon with upward arrow
- 7: 0 rpm
- 8: Gear icon
- 9: Gear icon with slash
- 10: Sum icon with 689.8 Mg/ha
- 11: Gear icon
- 12: Green box icon with 0.0 Mg/ha
- 13: Blue box icon
- 14: Trapezoidal display showing 27.7 kg/ha
- 15: Trapezoidal display showing 0.0 kg/ha

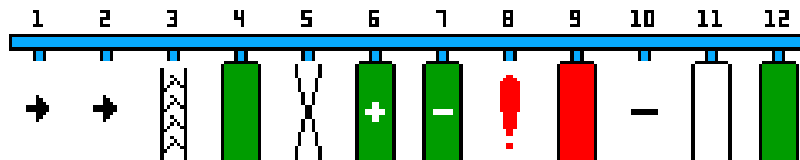



## NAVIGATION MENU WORK

Ce menu s'utilise lors du semis, il permet :

- de régler et visualiser la population de semis
- de visualiser la vitesse d'avancement
- de remplir le disque de distribution avant chaque passe
- de gérer les coupures de rangs (en manuel, en automatique ou en séquentiel)

- ①- Vitesse de travail
- ②- Compteur d'hectares actif
- ③- Espace entre graines
- ④- État de chaque rang :
- ⑤- Visualisation du mode jalonnage
- ⑥- Indication semoir relevé ou baissé
- ⑦- Contrôle de rotation de turbine
- ⑧- Remplissage du disque en cours
- ⑨- Activation de la fonction TC-SC côté ECU semoir
- ⑩- Densité de population souhaitée
- ⑪- Moyenne de densité sur tous les rangs
- ⑫- Densité sur le rang (balayage rang par rang)
- ⑬- Visualisation et contrôle de la rampe Fertiliseur
- ⑭- Visualisation et contrôle de la rampe Microsem insecticide
- ⑮- Visualisation et contrôle de la rampe Microsem hélicide

## NAVEGACIÓN MENÚ WORK

Este menú se utiliza durante la siembra, y permite:

- ajustar y visualizar la población de semillas
- visualizar la velocidad de avance
- llenar el disco de distribución antes de cada paso
- gestionar los cortes de filas (en manual, en automático o en secuencial)

- ①- Velocidad de trabajo
- ②- Contador de hectáreas activo
- ③- Espacio entre granos
- ④- Estado de cada fila
- ⑤- Visualización del modo jalonado
- ⑥- Indicación de sembradora elevada o bajada
- ⑦- Control de giro de turbina
- ⑧- Llenado del disco en curso
- ⑨- Activación de la función TC-SC lado ECU sembradora
- ⑩- Densidad de población deseada
- ⑪- Media de la densidad en todas las filas
- ⑫- Densidad en la fila (barrido fila por fila)
- ⑬- Visualización y control de la rampa Fertilizador
- ⑭- Visualización y control de la rampa Microsem insecticida
- ⑮- Visualización y control de la rampa Microsem helicida

## WORK MENU NAVIGATION

This menu is used when sowing, it allows you to:

- display and set the seed population
- display the travel speed
- fill the metering disk before each run
- manage row cut-offs (manually, automatically or sequentially)

- ①- Working speed
- ②- Hectare meter active
- ③- Space between seeds
- ④- Status of each row:
- ⑤- Tramline mode display
- ⑥- Planter raised or lowered indication
- ⑦- Turbine rotation control
- ⑧- Filling current disk
- ⑨- Activation of TC-SC function planter ECU side
- ⑩- Required population density
- ⑪- Density average on all rows
- ⑫- Density on the row (scanning row by row)
- ⑬- Display and control of the fertiliser placement boom
- ⑭- Display and control of the Microsem insecticide boom
- ⑮- Display and control of the Microsem helicide boom

## NAVIGAZIONE MENU WORK

Questo menu si utilizza durante la semina, consente:

- di regolare e di visualizzare la popolazione di semina
- di visualizzare la velocità di azionamento
- di riempire il disco di distribuzione prima di ogni passaggio
- di gestire le interruzioni di file (in modo manuale, automatico o sequenziale)

- ①- Velocità di lavoro
- ②- Contatore di ettari attivo
- ③- Spazio tra semi
- ④- Stato di ogni fila:
- ⑤- Visualizzazione del modo picchettamento
- ⑥- Indicazione seminatrice alzata o abbassata
- ⑦- Controllo di rotazione della turbina
- ⑧- Riempimento del disco in corso
- ⑨- Attivazione della funzione TC-SC lato ECU seminatrice
- ⑩- Densità di popolazione desiderata
- ⑪- Media della densità su tutte le file
- ⑫- Densità sulla fila (analisi fila per fila)
- ⑬- Visualizzazione e controllo della rampa Fertilizzatore
- ⑭- Visualizzazione e controllo della rampa Microsem insetticida
- ⑮- Visualizzazione e controllo della rampa Microsem elicida

# MENU WORK

WORK

	0.0 km/h		5/8		
	0.00 ha				
	13.3 cm		0 rpm		
<div style="display: flex; justify-content: space-around;"> <span>1</span><span>2</span><span>3</span><span>4</span> </div>					
$\Sigma \rightarrow$	100.0 t/ha	$\Sigma \sim$	0.0 t/ha		0.0 t/ha
	0.0 kg/ha				
	27.7 kg/ha				
	0.0 kg/ha				

...

	0.0 km/h				
	0.00 ha				
	13.3 cm				
<div style="display: flex; justify-content: space-around;"> <span>1</span><span>2</span><span>3</span><span>4</span> </div>					
$\Sigma \rightarrow$	100.0 t/ha	$\Sigma \sim$	0.0 t/ha		0.0 t/ha
	0.0 kg/ha				
	27.7 kg/ha				
	0.0 kg/ha				

...	

...	

## NAVIGATION MENU WORK



- Chargement du disque de distribution avant départ



- Coupure de rang séquentielle par la gauche et par la droite « arrêt du rang »



- Coupure de rang séquentielle par la gauche et par la droite « mise en marche »



- Gestion marche/arrêt des moteurs

Rampe Fertiliseur - Rampe Microsem insecticide et hélicide



- Gestion du mode jalonnage



- Accès au menu « réglage de la population de semis »



- Gestion de la dose d'engrais

Rampe Fertiliseur - Rampe Microsem insecticide et hélicide



- Gestion des coupures de rangs permanentes



- Accès aux commandes suivantes



- Retour au menu précédent

## WORK MENU NAVIGATION



- Loading metering disk before start



- Sequential row cut-off by the left and right "switching off the row"



- Sequential row cut-off by the left and right "start-up"



- On/off management of motors

Fertiliser placement unit boom - Insecticide and helicide Microsem boom



- Tramline mode management



- Access to the "seed population setting" menu



- Management of fertilizer amount

Fertilizer placement unit boom - Insecticide and helicide Microsem boom



- Permanent row cut-off management



- Access to the next commands



- Return to the previous menu

## NAVEGACIÓN MENÚ WORK



- Carga del disco de distribución antes de la salida



- Corte de fila secuencial por la izquierda y por la derecha «parada de fila»



- Corte de fila secuencial por la izquierda y por la derecha «puesta en marcha»



- Gestión marcha/parada de los motores

Rampa Fertilizador - Rampa Microsem insecticida y helicida



- Gestión del modo jalonado



- Acceso al menú «ajuste de la población de siembra»



- Gestión de la dosis de abono

Rampa Fertilizador - Rampa Microsem insecticida y helicida



- Gestión de los cortes de filas permanentes



- Acceso a los comandos siguientes



- Vuelta al menú anterior

## NAVIGAZIONE MENU WORK



- Caricamento del disco di distribuzione prima dell'avvio



- Interruzione sequenziale di fila da sinistra e da destra «arresto della fila»



- Interruzione sequenziale di fila da sinistra e da destra «messa in moto»



- Gestione accensione/spengimento dei motori

Rampa Fertilizzatore - Rampa Microsem insetticida ed elicida



- Gestione del modo picchettamento



- Accesso al menu «regolazione della popolazione di semina»



- Gestione della dose di concime

Rampa Fertilizzatore - Rampa Microsem insetticida ed elicida



- Gestione delle interruzioni permanenti delle file



- Accesso ai seguenti comandi



- Ritorno al menu precedente

# MENU WORK

WORK

This screenshot shows the 'MENU WORK' interface with the following data and controls:

- Speed: 0.0 km/h
- Area: 0.00 ha
- Depth: 13.3 cm
- RPM: 0 rpm
- Rate 1: 0.0 kg/ha
- Rate 2: 27.7 kg/ha
- Rate 3: 0.0 kg/ha
- Rate 4: 0.0 kg/ha

The toolbar on the right contains several icons, with a blue box highlighting the top two: a circular arrow icon and a 'STOP' icon.

This screenshot shows the 'MENU WORK' interface with the following data and controls:

- Speed: 0.0 km/h
- Area: 0.00 ha
- Depth: 13.3 cm
- RPM: 0 rpm
- Rate 1: 0.0 kg/ha
- Rate 2: 27.7 kg/ha
- Rate 3: 0.0 kg/ha
- Rate 4: 0.0 kg/ha

The toolbar on the right contains several icons, with a blue box highlighting the bottom two: a 'STOP' icon and a circular arrow icon.



## NAVIGATION MENU WORK

### ► Le chargement du disque:



L'icône «remplissage du disque» s'utilise à chaque début de parcelle. Autre cas d'utilisation, si en milieu de parcelle, l'utilisateur coupe la turbine pour des raisons diverses, il est nécessaire de refaire le chargement du disque après redémarrage de la turbine.

Sur l'écran de travail, un disque clignotant  permet de voir l'opération de chargement des disques en cours.

### ► Les coupures de rang séquentielles:



- Arrêt des rangs par la gauche ou par la droite



- Mise en marche des rangs par la gauche ou par la droite

Utilisation pratique pour les passages en pointe.

Sur l'écran de travail, une flèche indique l'arrêt du rang.

Lors de la mise en marche du rang, la flèche disparaît et le rang revient.

## WORK MENU NAVIGATION

### ► Disk loading:



The "disk filling" icon is used at the start of each plot. Another example of when the icon is used: if, in the middle of the plot, the user switches off the turbine for any reason, it is necessary to reload the disk after restarting the turbine.

On the work screen, a flashing disk  allows you to see loading of current disks.

### ► Sequential row cut-offs:



- Switching off rows by the left or right



- Starting up rows by the left or right

Useful for runs with tip.

On the work screen, an arrow indicates the row being switched off. When starting up the row, the arrow disappears and the row returns.

## NAVEGACIÓN MENÚ WORK

### ► Carga del disco:



El icono «llenado del disco» se utiliza en cada comienzo de parcela. Otros casos de uso: si en medio de la parcela, el usuario corta la turbina por distintas razones, habrá que volver a cargar el disco una vez haya vuelto a arrancar la turbina.

En la pantalla de trabajo, un disco intermitente  permite ver la operación de carga de los discos en curso.

### ► Cortes de filas secuenciales:

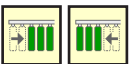

- Parada de filas por la izquierda o por la derecha



- Puesta en marcha de las filas por la izquierda o por la derecha

Uso práctico para los pasos en punta.

En la pantalla de trabajo, una flecha indica la parada de la fila.

En la puesta en marcha de la fila, la flecha desaparece y la fila vuelve.

## NAVIGAZIONE MENU WORK

### ► Il caricamento del disco:



L'icona «riempimento del disco» si utilizza ad ogni inizio di parcela. Altro caso di utilizzo, se a metà parcela, l'utente stacca la turbina per qualsiasi motivo, occorre procedere nuovamente al caricamento del disco dopo il riavvio della turbina.

Sul display di lavoro, un disco lampeggiante  consente di vedere l'operazione di caricamento dei dischi in corso.

### ► Le interruzioni sequenziali di file:



- Interruzione delle file da sinistra o da destra

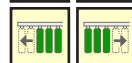

- Messa in moto delle file da sinistra o da destra

Uso comodo per i passaggi in punta.

Sul display di lavoro, una freccia indica l'interruzione della fila.

Durante la messa in moto della fila, la freccia scompare e torna la fila.

# MENU WORK

WORK

The main menu displays the following information:

- Speed: 0.0 km/h
- Area: 0.00 ha
- Depth: 13.3 cm
- Rate: 0 rpm
- Four vertical indicators labeled 1, 2, 3, 4
- Summary row:  $\Sigma \rightarrow$  100.0 Mgr/ha,  $\Sigma \sim$  0.0 Mgr/ha, 0.0 Mgr/ha
- Three fertilizer application rows:
  - 0.0 kg/ha
  - 27.7 kg/ha
  - 0.0 kg/ha
- Right-side menu with a highlighted 'STOP' button.



This interface shows the 'STOP' button on the left side of the right-side menu highlighted with a red border. A green arrow points left from the 'STOP' button.

This interface shows the 'STOP' button on the right side of the right-side menu highlighted with a red border. A green arrow points right from the 'STOP' button.

This interface shows the 'STOP' button at the top of the right-side menu highlighted with a red border. A green arrow points up from the 'STOP' button.

## NAVIGATION MENU WORK

### ► Gestion marche/arrêt des moteurs :



- Déplacer la flèche vers la droite pour choisir le moteur

- Déplacer la flèche vers la gauche pour choisir le moteur  
 - Flèche pour indiquer le moteur

- Arrêt du moteur

- Démarrage du moteur

- Arrêt de tous les moteurs

- Démarrage de tous les moteurs

- Retour au menu précédent

### ► État des moteurs:

- Le moteur ne tourne pas.  
(Le semoir est en marche ou le tracteur est arrêté ou les rangs de semence associés ne sont pas en train de semer).

- Le moteur ne tourne pas à cause d'une alarme.

- Le moteur est coupé manuellement par l'utilisateur.

(Réactiver le moteur avec la touche ).

- Le moteur tourne.

27.7 kg/ha

- Quantité cible programmée.

## WORK MENU NAVIGATION

### ► Motor on/off management:



- Move the arrow to the right to choose the motor

- Move the arrow to the left to choose the motor  
 - Arrow to indicate the motor

- Switching off the motor

- Starting the motor

- Switching off all the motors

- Starting all the motors

- Return to the previous menu

### ► Status of motors:

- The motor is not operating.  
(The planter is in operation or the tractor has stopped, or the associated seed rows are not sowing).

- The motor is not running because of an alarm.

- The motor has been switched off manually by the user.

(Restart the motor with the key ).

- The motor is in operation.

27.7 kg/ha

- Programmed target amount.

## NAVEGACIÓN MENÚ WORK

### ► Gestión marcha/parada de los motores:



- Desplazar la flecha hacia la derecha para elegir el motor

- Desplazar la flecha hacia la izquierda para elegir el motor  
 - Flecha para indicar el motor

- Parada del motor

- Arranque del motor

- Parada de todos los motores

- Arranque de todos los motores

- Vuelta al menú anterior

### ► Estado de los motores:

- El motor no gira.  
(La sembradora está en marcha o el tractor está parado o las filas de siembra asociadas no están sembrando).

- El motor no gira a causa de una alarma.

- El usuario ha cortado manualmente el motor

(Reactivar el motor con la tecla ).

- El motor gira.

27.7 kg/ha

- Cantidad objetivo programada.

## NAVIGAZIONE MENU WORK

### ► Gestione accensione/spengimento dei motori:



- Spostare la freccia a destra per scegliere il motore

- Spostare la freccia a sinistra per scegliere il motore  
 - Freccia per indicare il motore

- Spegnimento del motore

- Avvio del motore

- Spegnimento di tutti i motori

- Avvio di tutti i motori

- Ritorno al menu precedente

### ► Stato dei motori:

- Il motore non gira.  
(La seminatrice è in moto o il trattore è fermo o le file associate di semi non stanno seminando).

- Il motore non gira a causa di un allarme.

- Il motore è staccato manualmente dall'utente.

(Riattivare il motore con il tasto ).

- Il motore gira.

27.7 kg/ha

- Quantità target programmata.

# MENU WORK

WORK

0.0 km/h  
0.00 ha  
13.3 cm

1 2 3 4

Σ → 100.0 Mgr/ha    Σ ~ 0.0 Mgr/ha    0.0 Mgr/ha

0.0 kg/ha  
27.7 kg/ha  
0.0 kg/ha

0.0 km/h  
0.04 ha  
13.3 cm

1 2 3 4

Σ → 100.0 Mgr/ha    Σ ~ 0.0 Mgr/ha    0.0 Mgr/ha

0.0 kg/ha  
27.7 kg/ha  
0.0 kg/ha

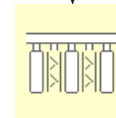
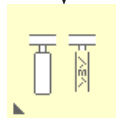
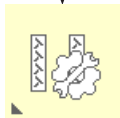

**RÉGLAGE DU JALONNAGE**

Largueur de traitement: 24.0 m  
Largueur de voie: 2.00 m  
Bord du champs: gauche  
Largueur des pneus: 60 cm  
Espacement min. plants: 0 cm  
Démarrer par un demi-semoir: **ARRÊT**

Allee de circulation  
Tracage: **ARRÊT**  
Marquage: **ARRÊT**

Densité des grains  
Augmentation de: 10 %  
sur les rangs voisins: **MARCHE**

SC Marquage  
Automatiquement allée **MARCHE**  
Manuellement allée **MARCHE**

0.0 km/h  
0.04 ha  
13.3 cm

1 2 3 4

Σ → 100.0 Mgr/ha    Σ ~ 0.0 Mgr/ha    0.0 Mgr/ha

0.0 kg/ha  
27.7 kg/ha  
0.0 kg/ha

0.0 km/h  
0.04 ha  
13.3 cm

1 2 3 4

Σ → 100.0 Mgr/ha    Σ ~ 0.0 Mgr/ha    0.0 Mgr/ha

0.0 kg/ha  
27.7 kg/ha  
0.0 kg/ha



## NAVIGATION MENU WORK

### ► Gestion du mode jalonnage :



- Accès aux réglages du jalonnage



- Accès au mode jalonnage manuel



- Activation du mode jalonnage automatique



- Retour au menu précédent

## WORK MENU NAVIGATION

### ► Tramline mode management:



- Access to tramline settings



- Access to manual tramline mode



- Activation of the automatic tramline mode



- Return to the previous menu

## NAVEGACIÓN MENÚ WORK

### ► Gestión del modo jalonado:



- Acceso a los ajustes del jalonado



- Acceso al modo jalonado manual



- Activación del modo jalonado automático



- Vuelta al menú anterior

## NAVIGAZIONE MENU WORK

### ► Gestione del modo picchettamento:



- Accesso alle regolazioni del picchettamento



- Accesso al modo picchettamento manuale



- Attivazione del modo picchettamento automatico



- Ritorno al menu precedente

# MENU WORK

WORK

	0.0 km/h		
	0.04 ha		
	13.3 cm		
$\Sigma \rightarrow$	100.0 Mg/ha	$\Sigma \sim$	0.0 Mg/ha
	0.0 kg/ha		
	27.7 kg/ha		
	0.0 kg/ha		

RÉGLAGE DU JALONNAGE

Largeur de traitement:	24.0 m	
Largeur de voie:	2.00 m	
Bord du champs:	gauche	
Largeur des pneus:	60 cm	
Espacement min. plants:	0 cm	
Démarrer par un demi-semoir:	ARRET	
Allée de circulation		
Traçage:	ARRET	
Marquage:	ARRET	
Densité des grains		
Augmentation de:	10 %	
sur les rangs voisins:	MARCHE	
SC Marquage		
Automatiquement allée	MARCHE	
Manuellement allée	MARCHE	

## NAVIGATION MENU WORK

### ► Réglages du jalonage :



Paramétrages :

- ① - Largeur de traitement
- ② - Largeur de voie
- ③ - Position du bord du champ (départ du semis)
- ④ - Largeur des pneus
- ⑤ - Espacement minimum des plants par rapport à la roue du pulvérisateur
- ⑥ - Démarrer par un demi-semoir
- ⑦ - Voie de circulation (fonction traçage ou marquage)
- ⑧ - Augmentation de la densité sur les rangs voisins
- ⑨ - Coupure des rangs avec la fonction TC-SC

## WORK MENU NAVIGATION

### ► Tramline settings:



Settings:

- ① - Width of treatment
- ② - Track width
- ③ - Position of the edge of the field (start of sowing)
- ④ - Tyre width
- ⑤ - Minimum distance of plants in relation to the sprayer wheel
- ⑥ - Start with a half-width
- ⑦ - Tramline (tracing or marking out function)
- ⑧ - Increasing density on adjacent rows
- ⑨ - Row cut-off with the TC-SC function

## NAVEGACIÓN MENÚ WORK

### ► Ajustes del jalonado:



Parámetros:

- ① - Anchura de tratamiento
- ② - Anchura de vía
- ③ - Posición del borde del campo (salida de las semillas)
- ④ - Anchura de las ruedas
- ⑤ - Espaciamento mínimo de las plantas en relación a la rueda del pulverizador
- ⑥ - Arrancar con una mitad de anchura.
- ⑦ - Vía de circulación (función trazado o marcado)
- ⑧ - Aumento de la densidad en las filas vecinas
- ⑨ - Corte de las filas con la función TC-SC

## NAVIGAZIONE MENU WORK

### ► Regolazioni del picchettamento:



Impostazioni:

- ① - Larghezza di trattamento
- ② - Larghezza di via
- ③ - Posizione dal bordo del campo (avvio della semina)
- ④ - Larghezza delle gomme
- ⑤ - Distanziamento minimo delle piantine rispetto alla ruota del polverizzatore
- ⑥ - Iniziare con una mezza larghezza
- ⑦ - Via di circolazione (funzione tracciatura o marcatura)
- ⑧ - Aumento della densità sulle file vicine
- ⑨ - Interruzione delle file con la funzione TC-SC

# MENU WORK

WORK

0.0 km/h  
0.04 ha  
13.3 cm

1 2 3 4

100.0 Mgr/ha   0.0 Mgr/ha   0.0 Mgr/ha

0.0 kg/ha  
27.7 kg/ha  
0.0 kg/ha

0.0 km/h  
0.04 ha  
13.3 cm

2 3 4

100.0 Mgr/ha   0.0 Mgr/ha   0.0 Mgr/ha

0.0 kg/ha  
27.7 kg/ha  
0.0 kg/ha



## NAVIGATION MENU WORK

### ► Mode jalonnage manuel :



Commande permettant de couper un ou plusieurs rangs lors d'un passage. Cette fonction s'arrête automatiquement lors du passage suivant. À la fin du passage lors du demi-tour, le fait de lever le semoir désactive le jalonnage manuel et les rangs se réactivent.



- Mise en marche de tous les rangs



- Jalonnage manuel tous les rangs



- Déplacer la flèche vers la droite pour choisir le moteur



- Déplacer la flèche vers la gauche pour choisir le moteur



- Flèche pour indiquer le moteur



- Jalonnage manuel sur un rang



- Mise en marche du rang



- Retour au menu précédent

## WORK MENU NAVIGATION

### ► Manual tramline mode:



Command allowing one or several rows to be cut off during a run. This function stops automatically during the next run. At the end of the run, when performing a U-turn, raising the planter deactivates manual tramline mode and the rows restart.



- Start-up of all rows



- Manual tramline all rows



- Move the arrow to the right to choose the motor



- Move the arrow to the left to choose the motor



- Arrow to indicate the motor



- Manual tramline on one row



- Start-up of the row



- Return to the previous menu

## NAVEGACIÓN MENÚ WORK

### ► Modo jalonado manual:



Comando que permite cortar una o más filas durante una pasada. Esta función se para automáticamente en la pasada siguiente. Al final de la pasada durante la media vuelta, al levantar la sembradora se desactiva el jalonado manual y las filas se reactivan.



- Puesta en marcha de todas las filas



- Jalonado manual de todas las filas



- Desplazar la flecha hacia la derecha para elegir el motor



- Desplazar la flecha hacia la izquierda para elegir el motor



- Flecha para indicar el motor



- Jalonado manual en una fila



- Puesta en marcha de la fila



- Vuelta al menú anterior

## NAVIGAZIONE MENU WORK

### ► Modo picchettamento manuale:



Comando che consente di interrompere una o più file durante un passaggio. Questa funzione si ferma automaticamente durante il passaggio successivo. Alla fine del passaggio durante il mezzo giro, il fatto di sollevare la seminatrice disattiva il picchettamento manuale e le file si riattivano.



- Messa in moto di tutte le file



- Picchettamento manuale di tutte le file



- Spostare la freccia a destra per scegliere il motore



- Spostare la freccia a sinistra per scegliere il motore



- Freccia per indicare il motore



- Picchettamento manuale su una fila



- Messa in moto della fila



- Ritorno al menu precedente

# MENU WORK

WORK

0.0 km/h | 0.04 ha | 13.3 cm

1 2 3 4

Σ → 100.0 NGr/ha | Σ ~ 0.0 NGr/ha | 0.0 NGr/ha

0.0 kg/ha

27.7 kg/ha

0.0 kg/ha

0.0 km/h | 1/8 | 0.04 ha | 13.3 cm

1 2 3 4

Σ → 100.0 NGr/ha | Σ ~ 0.0 NGr/ha | 0.0 NGr/ha

0.0 kg/ha

27.7 kg/ha

0.0 kg/ha

0.0 km/h | 6/8 | 0.05 ha | 13.3 cm

1 2 3 4

Σ → 100.3 NGr/ha | Σ ~ 0.0 NGr/ha | 0.0 NGr/ha

0.0 kg/ha

27.7 kg/ha

0.0 kg/ha

## NAVIGATION MENU WORK

### ► Mode jalonnage automatique :



- Accès aux réglages du jalonnage



- Accès au mode jalonnage manuel



- Activation du mode jalonnage automatique



- Programme de jalonnage actif



- Avancer dans le programme de jalonnage



- Reculer dans le programme de jalonnage



- Mise en pause du programme de jalonnage



- Programme de jalonnage en pause



- Retour au début du programme



- Départ du jalonnage par la gauche ou par la droite



- Retour au menu précédent

## WORK MENU NAVIGATION

### ► Automatic tramline mode:



- Access to tramline settings



- Access to manual tramline mode



- Activation of automatic tramline mode



- Tramline programme active



- Go forward in the tramline programme



- Go back in the tramline programme



- Placing tramline programme on pause



- Tramline programme paused



- Return to the start of the programme



- Starting tramline by the left or right



- Return to the previous menu

## NAVEGACIÓN MENÚ WORK

### ► Modo jalonado automático:



- Acceso a los ajustes del jalonado



- Acceso al modo de jalonado manual



- Activación del modo de jalonado automático



- Programa de jalonado activo



- Avanzar en el programa de jalonado



- Retroceder en el programa de jalonado



- Puesta en pausa del programa de jalonado



- Programa de jalonado en pausa



- Vuelta al comienzo del programa



- Comienzo del jalonado por la izquierda o por la derecha



- Vuelta al menú anterior

## NAVIGAZIONE MENU WORK

### ► Modo picchettamento automatico:



- Accesso alle regolazioni del picchettamento



- Accesso al modo picchettamento manuale



- Attivazione del modo picchettamento automatico



- Programma di picchettamento attivo



- Avanzare nel programma di picchettamento



- Indietreggiare nel programma di picchettamento



- Pausa del programma di picchettamento



- Programma di picchettamento in pausa



- Ritorno all'inizio del programma



- Avvio del picchettamento da sinistra o da destra



- Ritorno al menu precedente

# MENU WORK

WORK

0.0 km/h

0.00 ha

13.3 cm

1 2 3 4

100.0 Mgr/ha

0.0 Mgr/ha

0.0 Mgr/ha

0.0 kg/ha

27.7 kg/ha

0.0 kg/ha

0.0 km/h

0.04 ha

13.3 cm

1 2 3 4

100.0 Mgr/ha

0.0 Mgr/ha

0.0 Mgr/ha

0.0 kg/ha

27.7 kg/ha

0.0 kg/ha

## NAVIGATION MENU WORK

### ► Gestion de la population de semis :



- Augmentation de la distance entre graines



- Diminution de la distance entre graines



- Augmentation de la dose par hectare



- Diminution de la dose par hectare



- Retour aux valeurs du dernier démarrage de la console



- Retour au menu précédent

## WORK MENU NAVIGATION

### ► Seed population management:



- Increasing the distance between seeds



- Reducing the distance between seeds



- Increasing the amount per hectare



- Reducing the amount per hectare



- Return to the values of the last console start-up



- Return to the previous menu

## NAVEGACIÓN MENÚ WORK

### ► Gestión de la población de semillas:



- Aumento de la distancia entre granos



- Disminución de la distancia entre granos



- Aumento de la dosis por hectárea



- Disminución de la dosis por hectárea



- Vuelta a los valores del último arranque de la consola



- Vuelta al menú anterior

## NAVIGAZIONE MENU WORK

### ► Gestione della popolazione di semina:



- Aumento della distanza tra i semi



- Diminuzione della distanza tra i semi



- Aumento della dose per ettaro



- Diminuzione della dose per ettaro



- Ritorno ai valori dell'ultimo avvio della console



- Ritorno al menu precedente



# MENU WORK

WORK

	0.0 km/h		
	0.00 ha		
	13.3 cm		
$\Sigma \rightarrow$	100.0 tGr/ha	$\Sigma \sim$	0.0 tGr/ha
	0.0 kg/ha		
	27.7 kg/ha		
	0.0 kg/ha		



	0.0 km/h		
	0.00 ha		
	13.3 cm		
$\Sigma \rightarrow$	100.0 tGr/ha	$\Sigma \sim$	0.0 tGr/ha
	0.0 kg/ha		
	27.7 kg/ha		
	0.0 kg/ha		

## NAVIGATION MENU WORK

### ► Gestion des doses d'engrais et de Microsem :



- Augmentation de la dose souhaitée



- Diminution de la dose souhaitée



- Retour au menu précédent



- Un appui long sur la touche augmente ou diminue la valeur cible par 1 kg/ha.



- Une impulsion sur la touche augmente ou diminue la valeur cible par 0,1 kg/ha.

## WORK MENU NAVIGATION

### ► Management of Microsem and fertilizer amounts:



- Increasing the required amount



- Decreasing the required amount



- Return to the previous menu



- Pressing and holding down the key allows you to increase or decrease the target value by 1 kg / ha.



- Briefly pressing the key allows you to increase or decrease the target value by 0.1 kg / ha.

## NAVEGACIÓN MENÚ WORK

### ► Gestión de las dosis de abono y de Microsem:



- Aumento de la dosis deseada



- Disminución de la dosis deseada



- Vuelta al menú anterior



- Una pulsación larga de la tecla aumenta o disminuye el valor objetivo en 1 kg/ha.



- Una pulsación corta de la tecla aumenta o disminuye el valor objetivo en 0,1 kg/ha.

## NAVIGAZIONE MENU WORK

### ► Gestione delle dosi di concime e di Microsem:



- Aumento della dose desiderata



- Diminuzione della dose desiderata



- Ritorno al menu precedente



- Una pressione lunga sul tasto aumenta o diminuisce il valore target per fasce di 1 kg / ha.



- Una sola pressione sul tasto aumenta o diminuisce il valore target di 0,1 kg / ha.

# MENU WORK

WORK

0.0 km/h

0.00 ha

13.3 cm

1 2 3 4

100.0 Mgr/ha

0.0 Mgr/ha

0.0 Mgr/ha

0.0 kg/ha

27.7 kg/ha

0.0 kg/ha

0.0 km/h

0.05 ha

13.3 cm

1 3 4

100.3 Mgr/ha

0.0 Mgr/ha

0.0 Mgr/ha

150.0 kg/ha

10.0 kg/ha

6.0 kg/ha

## NAVIGATION MENU WORK

### ► Gestion des coupures permanentes :



Commandes permettant de couper un ou plusieurs rangs de façon permanente à n'importe quel moment.



- Mise en marche de tous les rangs



- Arrêt de tous les rangs



- Déplacer la flèche vers la droite pour choisir le moteur



- Déplacer la flèche vers la gauche pour choisir le moteur



- Flèche pour indiquer le moteur



- Arrêt sur un rang



- Mise en marche du rang



- Retour au menu précédent

## NAVEGACIÓN MENÚ WORK

### ► Gestión de los cortes permanentes:



Comandos que permiten cortar una o varias filas de manera permanente en cualquier momento.



- Puesta en marcha de todas las filas



- Parada de todas las filas



- Desplazar la flecha hacia la derecha para elegir el motor



- Desplazar la flecha hacia la izquierda para elegir el motor



- Flecha para indicar el motor



- Parada en una fila



- Puesta en marcha de la fila



- Vuelta al menú anterior

## WORK MENU NAVIGATION

### ► Management of permanent cut-offs:



Commands allowing you to cut off one or several rows permanently at any time.



- Starting up all the rows



- Switching off all the rows



- Move the arrow to the right to choose the motor



- Move the arrow to the left to choose the motor



- Arrow to indicate the motor



- Switching off on a row



- Starting up the row



- Return to the previous menu

## NAVIGAZIONE MENU WORK

### ► Gestione delle interruzioni permanenti:



Comandi che consentono di interrompere una o più file in modo permanente in qualunque momento.



- Messa in moto di tutte le file



- Interruzione di tutte le file



- Spostare la freccia a destra per scegliere il motore



- Spostare la freccia a sinistra per scegliere il motore



- Freccia per indicare il motore



- Interruzione di una fila



- Messa in moto della fila



- Ritorno al menu precedente

# MENU TEST

WORK

TEST SEMOIR	
JR-Version: 6.13 BM02	Semoir →
LIN-Version: 8.09	Fert. ←
Speed switch: 0.00	Microsen ▶
	⋮ TEST
	↺ ↻ ↻

7.03 7.03  
7.03 7.03  
↓  
1 2 3 4  
0 0 0 0  
U/min

Vitesse de sim.: 0.0 km/h ↑

Tension du moteur: 11.8 V

TEST SEMOIR	
1 JR-Version: 6.13 BM02	
2 LIN-Version: 8.09	
3 Speed switch: 0.00	
4 7.03 7.03	
5 7.03 7.03	
6 ↓	
7 1 2 3 4	
8 0 0 0 0	
9 U/min	
7 Vitesse de sim.: 0.0 km/h	10 ↑
8 Tension du moteur: 11.8 V	



## NAVIGATION MENU TEST

### ► Descriptif de l'écran :

- ①- Version du logiciel
- ②- Version du logiciel
- ③- Version du logiciel
- ④- Version des cartes ECU moteur
- ⑤- Flèche pour indiquer le moteur
- ⑥- Affichage des rangs
- ⑦- Rotation des moteurs en tr/min
- ⑧- Vitesse de simulation du test
- ⑨- Tension d'alimentation reçue par la carte
- ⑩- Test des capteurs de position du semoir

## TEST MENU NAVIGATION

### ► Description of the screen:

- ①- Software version
- ②- Software version
- ③- Software version
- ④- Version of the PCB motor ECU
- ⑤- Arrow to indicate the motor
- ⑥- Row display
- ⑦- Rotation of motors in revs/min
- ⑧- Test simulation speed
- ⑨- Supply voltage received by the board
- ⑩- Planter position sensor test

## NAVEGACIÓN MENÚ PRUEBA

### ► Descripción de la pantalla:

- ①- Versión del programa
- ②- Versión del programa
- ③- Versión del programa
- ④- Versión de las tarjetas ECU motor
- ⑤- Flecha para indicar el motor
- ⑥- Visualización de las filas
- ⑦- Giro de los motores en rpm
- ⑧- Velocidad de simulación de la prueba
- ⑨- Tensión de alimentación recibida por la tarjeta
- ⑩- Prueba de los captadores de posición de la sembradora

## NAVIGAZIONE MENU TEST

### ► Descrizione della schermata:

- ①- Versione del software
- ②- Versione del software
- ③- Versione del software
- ④- Versione delle schede ECU motore
- ⑤- Freccia per indicare il motore
- ⑥- Visualizzazione delle file
- ⑦- Rotazione dei motori in giri/minuti
- ⑧- Velocità di simulazione del test
- ⑨- Tensione di alimentazione ricevuta dalla scheda
- ⑩- Test dei sensori di posizione della seminatrice

# MENU TEST

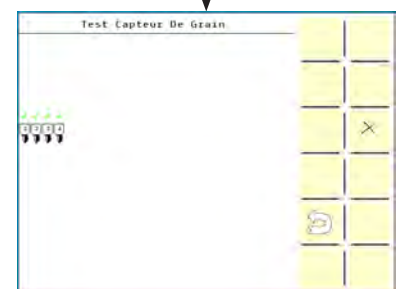
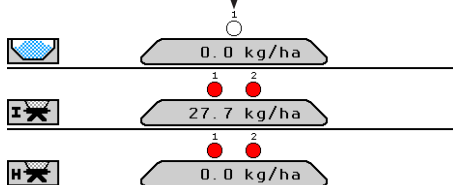
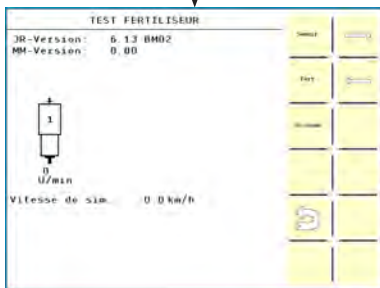
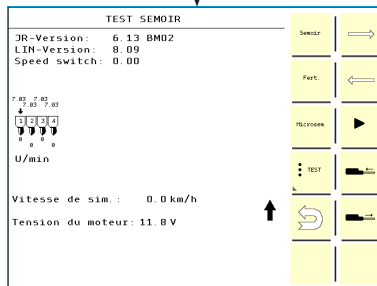
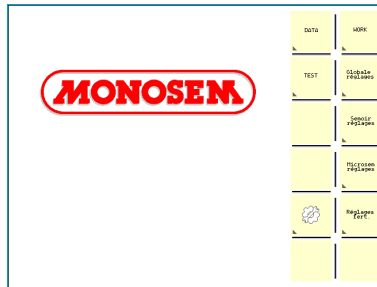

**!** Le test des moteurs Fertiliseur et Microsem n'est possible que si l'étalonnage a été réalisé.

**!** Testing Microsem and fertilizer placement unit motors is only possible if calibration has been carried out.

**!** La prueba de los motores Fertilizador y Microsem solo es posible si se ha realizado la calibración.

**!** Il test dei motori Fertilizzatore e Microsem è possibile soltanto se è stata eseguita la calibrazione.

## NAVIGATION MENU TEST

### ► Test des moteurs électriques du semoir :



- Déplacer la flèche vers la droite pour choisir le moteur



- Déplacer la flèche vers la gauche pour choisir le moteur



- Flèche pour indiquer le moteur



- Test automatique des moteurs d'éléments semeurs



- Test du vérin électrique de prélevé (rentrée de tige)



- Test du vérin électrique de prélevé (sortie de tige)



- Activation de la page test des moteurs d'éléments semeurs



- Activation de la page test des moteurs du Fertiliseur



- Activation de la page test des moteurs du Microsem



- Accès à la page test des cellules



- Retour au menu précédent



- Initialisation du test des cellules

## TEST MENU NAVIGATION

### ► Planter electric motor test:



- Move the arrow to the right to choose the motor



- Move the arrow to the left to choose the motor



- Arrow to indicate the motor



- Seed unit motor automatic test



- Pre-emergence marker test (retraction of rod)



- Pre-emergence marker test (extension of rod)



- Activation of seed unit motor test page



- Activation of fertilizer placement unit motor test page



- Activation of Microsem motor test page



- Access to seed sensor test page



- Return to the previous menu



- Initialisation of seed sensor test

## NAVEGACIÓN MENÚ PRUEBA

### ► Prueba de los motores eléctricos de la sembradora:



- Desplazar la flecha hacia la derecha para elegir el motor



- Desplazar la flecha hacia la izquierda para elegir el motor



- Flecha para indicar el motor



- Prueba automática de los motores de los elementos sembradores



- Prueba del trazador de pre-emergencia (recogida de vástago)



- Prueba del trazador de pre-emergencia (salida de vástago)



- Activación de la página de prueba de los motores de los elementos sembradores



- Activación de la página de prueba de los motores del Fertilizador



- Activación de la página de prueba de los motores de Microsem



- Acceso a la página de prueba de las células



- Vuelta al menú anterior



- Inicialización de la prueba de las células

## NAVIGAZIONE MENU TEST

### ► Test dei motori elettrici della seminatrice:



- Spostare la freccia a destra per scegliere il motore



- Spostare la freccia a sinistra per scegliere il motore



- Freccia per indicare il motore



- Test automatico dei motori di elementi seminatori



- Test del martinetto elettrico di pre-emergenza (rientro asta)



- Test del martinetto elettrico di pre-emergenza (uscita asta)



- Attivazione della pagina di test dei motori di elementi seminatori



- Attivazione della pagina di test dei motori del Fertilizzatore



- Attivazione della pagina di test dei motori del Microsem



- Accesso alla pagina di test delle celle



- Ritorno al menu precedente



- Inizializzazione del test delle celle

# MENU DATA



**Données**

1 2

ha 0.04 h 0.1

3 4 4

Σha 0.04 Σh 0

6 1

7 2

8 3

9 4

10 5

11

12

13

14

15

16

17

18

19

20

21

22

23

24

25

26

27

28

29

30

31

32

33

34

35

36

37

38

39

40

41

42

43

44

45

46

47

48

49

50

51

52

53

54

55

56

57

58

59

60

61

62

63

64

65

66

67

68

69

70

71

72

73

74

75

76

77

78

79

80

81

82

83

84

85

86

87

88

89

90

91

92

93

94

95

96

97

98

99

100

**Client**

5 1 6

Client

7 8

Debut: ---:--

Fin: ---:--

10 Temps de travail: 0h 00min

11 Superficie: 0.00 ha

9

START

X

12

13

14

15

16

17

18

19

20

21

22

23

24

25

26

27

28

29

30

31

32

33

34

35

36

37

38

39

40

41

42

43

44

45

46

47

48

49

50

51

52

53

54

55

56

57

58

59

60

61

62

63

64

65

66

67

68

69

70

71

72

73

74

75

76

77

78

79

80

81

82

83

84

85

86

87

88

89

90

91

92

93

94

95

96

97

98

99

100

## NAVIGATION MENU DATA

Ce menu permet de visualiser les paramètres tels que les surfaces semées et les heures travaillées.

- ①- Surface semée pour le compteur n° xx
- ②- Temps du semis pour le compteur n° xx
- ③- Surface semée totale
- ④- Temps de semis total
- ⑤- Numéro du compteur (n° 1 à n° 8)
- ⑥- Nom de l'utilisateur
- ⑦- Date du jour
- ⑧- Heure de début
- ⑨- Heure de fin
- ⑩- Temps de semis
- ⑪- Surface travaillée

## DATA MENU NAVIGATION

This menu allows parameters such as areas sowed and hours worked to be displayed.

- ①- Area sowed for meter no xx
- ②- Sowing time for meter no xx
- ③- Total area sowed
- ④- Total sowing time
- ⑤- Meter number (no 1 - no 8)
- ⑥- User name
- ⑦- Date
- ⑧- Start time
- ⑨- Finish time
- ⑩- Sowing time
- ⑪- Area worked

## NAVEGACIÓN MENÚ DATA

Este menú permite visualizar parámetros como la superficie sembrada o las horas trabajadas.

- ①- Superficie sembrada para el contador n° xx
- ②- Tiempo de siembra para el contador n° xx
- ③- Superficie sembrada total
- ④- Tiempo de siembra total
- ⑤- Número de contador (de 1 a 8)
- ⑥- Nombre del usuario
- ⑦- Fecha del día
- ⑧- Hora de inicio
- ⑨- Hora de fin
- ⑩- Tiempo de siembra
- ⑪- Superficie trabajada

## NAVIGAZIONE MENU DATI

Questo menu consente di visualizzare i parametri quali le superfici seminate e le ore lavorate.

- ①- Superficie seminata per il contatore numero xx
- ②- Tempo di semina per il contatore numero xx
- ③- Superficie seminata totale
- ④- Tempo di semina totale
- ⑤- Numero del contatore (da 1 a 8)
- ⑥- Nome dell'utente
- ⑦- Data del giorno
- ⑧- Ora di inizio
- ⑨- Ora di fine
- ⑩- Tempo di semina
- ⑪- Superficie lavorata

# MENU DATA

DATA

DATA

Données

ha: 0.04 h: 0.1

Σha: 0.04 Σh: 0

0-->ha  
0-->h

Supprimer les données?

Oui

Non

Client

Client

Debut: --:--

Fin: --:--

Temps de travail: 0h 00min

Superficie: 0.00ha

DEARR.

Client

Client

Debut: 15:56

Fin: --:--

Temps de travail: 0h 00min

Superficie: 0.00ha

ESC

Données

ha: 0.00 h: 0.0

Σha: 0.04 Σh: 0

ARRÊTER

Client

Client

Debut: 15:56

Fin: 15:56

Temps de travail: 0h 00min

Superficie: 0.00ha

→

→ ✓

USB

✕









Supprimer les données?

Oui









Non











## NAVIGATION MENU DATA

-  - Accès au menu DATA
-  - Remise à zéro des compteurs N°1 à N°8
-  - Accès aux données du compteur N°1
-  - Démarrage du compteur N°1
-  - Arrêt du compteur N°1
-  - Retour au menu précédent
-  - Compteur N°1 actif
-  - Enregistrement des données liées au compteur N°1
-  - Suppression de données liées au compteur N°1









## DATA MENU NAVIGATION

-  - Access to DATA menu
-  - Resetting meters N°1 - N°8
-  - Access to meter N°1 data
-  - Starting meter N°1
-  - Stopping meter N°1
-  - Return to previous menu
-  - Meter N°1 active
-  - Saving data about meter N°1
-  - Deleting data about meter N°1

## NAVEGACIÓN MENÚ DATA

-  - Acceso al menú DATA
-  - Puesta a cero de los contadores 1 a 8
-  - Acceso a los datos del contador n° 1
-  - Arranque del contador n° 1
-  - Parada del contador n° 1
-  - Vuelta al menú anterior
-  - Contador n° 1 activo
-  - Registro de datos correspondientes al contador n° 1
-  - Eliminación de datos correspondientes al contador n° 1

## NAVIGAZIONE MENU DATI

-  - Accesso al menu DATI
-  - Azzeramento dei contatori da 1 a 8
-  - Accesso ai dati del contatore numero 1
-  - Avvio del contatore numero 1
-  - Arresto del contatore numero 1
-  - Ritorno al menu precedente
-  - Contatore numero 1 attivo
-  - Registrazione dei dati connessi al contatore numero 1
-  - Cancellazione dei dati connessi al contatore numero 1

# MENU RÉGLAGES GLOBALES

Globale réglages

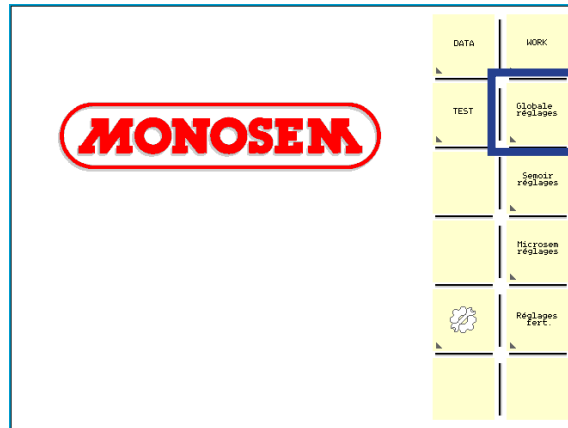

The image shows a detailed view of the 'REGLAGES GLOBAL' menu. The menu items and their values are as follows:

Item	Value
Impulsions/100m (with speaker icon)	10000
Impulsions/100m (with target icon)	17700
Pos. trav. capteur	intern
Volume (with speaker icon and arrows)	9 (0-9)
Volume (with speaker icon and arrows)	1 (0-9)
Timer (with clock icon)	20 s
Vitesse nominale	8.0 km/h

Numbered callouts (1-7) point to specific elements in the menu:

- 1: Gear icon at the top left.
- 2: First 'Impulsions/100m' value.
- 3: Second 'Impulsions/100m' value.
- 4: '100m' label next to the volume setting.
- 5: '100m' label next to the timer setting.
- 6: Speaker icon next to the volume setting.
- 7: 'Vitesse nominale' label.

## NAVIGATION MENU RÉGLAGES GLOBAUX



- Accès au menu réglages



- Accès à l'étalonnage du radar de vitesse



- Accès à l'étalonnage du codeur rotatif (Option)



- Accès aux réglages des semoirs mixtes



- Une configuration de semoir est active



- Accès aux réglages du contrôleur de tâches



- Retour au menu précédent

### ► Descriptif de l'écran :

- ① - Impulsions pour le radar de vitesse
- ② - Impulsions pour le codeur rotatif
- ③ - Capteur de relevage du semoir :  
intern : pour utilisation des capteurs sur éléments semeurs  
TECU analog : pour utilisation du relevage du tracteur  
TECU digital : pour utilisation du relevage du tracteur
- ④ - Indicateur tonalité du bip sonore (position basse)
- ⑤ - Indicateur tonalité du bip sonore (position haute)
- ⑥ - Réglage du temps avant l'activation du mode pause
- ⑦ - Vitesse théorique de travail

## NAVEGACIÓN MENÚ AJUSTES GLOBALES



- Acceso al menú ajustes



- Acceso al calibrado del radar de velocidad



- Acceso al calibrado del codificador giratorio (opción)



- Acceso a los ajustes de las sembradoras mixtas



- Una configuración de sembradora está activa



- Acceso a los ajustes del controlador de tareas



- Vuelta al menú anterior

### ► Descripción de la pantalla:

- ① - Impulsiones para el radar de velocidad
- ② - Impulsiones para el codificador giratorio
- ③ - Captador de elevación de la sembradora:  
intern: para uso de los captadores en elementos sembradores  
TECU analógico: para uso de elevación del tractor  
TECU digital: para uso de elevación del tractor
- ④ - Indicador de tonalidad del bip sonoro (posición baja)
- ⑤ - Indicador de tonalidad del bip sonoro (posición alta)
- ⑥ - Ajuste del tiempo antes de la activación del modo pausa
- ⑦ - Velocidad teórica de trabajo

## GENERAL SETTINGS MENU NAVIGATION



- Access to settings menu



- Access to speed radar calibration



- Access to rotary encoder calibration (available as an optional extra)



- Access to multi-purpose planter settings



- A planter configuration is active



- Access to task controller settings



- Return to previous menu

### ► Description of the screen:

- ① - Impulses for speed radar
- ② - Impulses for rotary encoder
- ③ - Planter lifting sensor:  
internal: for use of sensors on seed units  
TECU analogue: for tractor lifting use  
TECU digital: for tractor lifting use
- ④ - Beep tone indicator (low position)
- ⑤ - Beep tone indicator (high position)
- ⑥ - Time setting before activation of pause mode
- ⑦ - Theoretical working speed

## NAVIGAZIONE MENU REGOLAZIONI GLOBALI



- Accesso al menu regolazioni



- Accesso alla calibrazione del radar di velocità



- Accesso alla calibrazione dell'encoder rotante (Opzione)



- Accesso alle regolazioni delle seminatrici miste



- Una configurazione di seminatrice è attiva



- Accesso alle regolazioni del controllore di task



- Ritorno al menu precedente

### ► Descrizione della schermata:

- ① - Impulsi per il radar di velocità
- ② - Impulsi per l'encoder rotante
- ③ - Sensore di sollevamento della seminatrice:  
intern: per l'uso dei sensori sugli elementi seminatori  
TECU analog: per l'uso del sollevamento del trattore  
TECU digital: per l'uso del sollevamento del trattore
- ④ - Indicatore tonalità del segnale acustico (posizione bassa)
- ⑤ - Indicatore tonalità del segnale acustico (posizione alta)
- ⑥ - Regolazione del tempo prima dell'attivazione del modo pausa
- ⑦ - Velocità teorica di lavoro

# MENU RÉGLAGES GLOBALES

Globale réglages

REGLAGES GLOBAL

- Impulsions/100m: 10000
- Impulsions/100m: 17700
- Pos. trav. capteur: intern

9 (0-9)

1 (0-9)

20 s

Vitesse nominale: 8.0 km/h

Calibration 100m

Impulsions: 0

START

Abaaissez la machinette  
Conduire à la vitesse  
de travail.  
Lorsque vous passez la  
ligne de départ, appuyez  
sur la touche "START"

Calibration 100m

Impulsions: 0

START

Abaaissez la machinette  
Conduire à la vitesse  
de travail.  
Lorsque vous passez la  
ligne de départ, appuyez  
sur la touche "START"

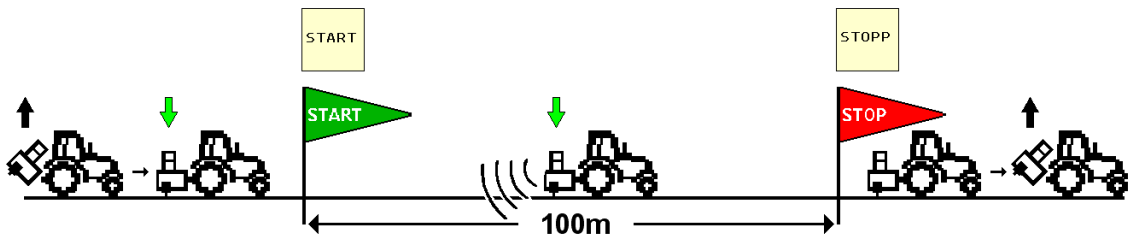

REGLAGES GLOBAL

- Impulsions/100m: 10000
- Impulsions/100m: 17700
- Pos. trav. capteur: intern

9 (0-9)

1 (0-9)

20 s

Vitesse nominale: 8.0 km/h

REGLAGES GLOBAL

- Impulsions/100m: 10000
- Impulsions/100m: 17700
- Pos. trav. capteur: intern

9 (0-9)

1 (0-9)

20 s

Vitesse nominale: 8.0 km/h

## NAVIGATION MENU RÉGLAGES GLOBAUX

### ► Calibration de la vitesse semoir :



- Accès à l'étalonnage du radar de vitesse



- Accès à l'étalonnage du codeur rotatif (Option)

## GENERAL SETTINGS MENU NAVIGATION

### ► Planter speed calibration:



- Access to speed radar calibration



- Access to rotary encoder calibration (available as an optional extra)

## NAVEGACIÓN MENÚ AJUSTES GLOBALES

### ► Calibración de la velocidad de la sembradora:



- Acceso al calibrado del radar de velocidad



- Acceso al calibrado del codificador giratorio (opción)

## NAVIGAZIONE MENU REGOLAZIONI GLOBALI

### ► Calibrazione della velocità della seminatrice:



- Accesso alla calibrazione del radar di velocità



- Accesso alla calibrazione dell'encoder rotante (Opzione)

# MENU RÉGLAGES GLOBALES

Globale  
réglages

REGLAGES GLOBAL

Impulsions/100m: 10000

Impulsions/100m: 17700

Pos. trav. capteur: intern

9 (0-9)

1 (0-9)

20 s

Vitesse nominale: 8.0 km/h

180m

180m





Configuration de ligne

Inter - rangs: 75.0 cm

1 2 3 4

1

2

3



4







Configuration de ligne

Inter - rangs: 75.0 cm

1 2 3 4









Configuration de ligne

Le système doit être redémarré pour le transfert de données.

Restart



## NAVIGATION MENU RÉGLAGES GLOBAUX

### ► Réglages des semoirs mixtes :



- Configuration semoir 1



- Configuration semoir 1 active



- Configuration semoir 2



- Configuration semoir 3



- Configuration semoir 4



- Accès au paramétrage de la configuration du semoir



- Retour au menu précédent

Exemples de configurations :

- Semoir 6-7 rangs

Par défaut, la configuration 1 correspond au semoir complet 7 rangs à 60 cm, la configuration 2 correspond à la version semoir 6 rangs à 75 cm.

- Semoir 6-8 rangs

- Semoir 6-9 rangs

- Semoir 8-9 rangs

- Semoir 8-12 rangs

☞ Pour toutes modifications apportés à la configuration, l'ECU demande à être redémarré pour prendre en compte les modifications.

## NAVEGACIÓN MENÚ AJUSTES GLOBALES

### ► Ajustes de las sembradoras mixtas:



- Configuración sembradora 1



- Configuración sembradora 1 activa



- Configuración sembradora 2



- Configuración sembradora 3



- Configuración sembradora 4



- Acceso a los parámetros de la configuración de la sembradora



- Vuelta al menú anterior

Ejemplos de configuraciones:

- Sembradora 6-7 filas

Por defecto, la configuración 1 corresponde a la sembradora completa 7 filas a 60 cm, la configuración 2 corresponde a la versión sembradora 6 filas a 75 cm.

- Sembradora 6-8 filas

- Sembradora 6-9 filas

- Sembradora 8-9 filas

- Sembradora 8-12 filas

☞ Para todas las modificaciones introducidas en la configuración, el ECU solicita ser reiniciado para tener en cuenta las modificaciones.

## GENERAL SETTINGS MENU NAVIGATION

### ► Multi-purpose planter settings:



- Planter 1 configuration



- Planter 1 configuration active



- Planter 2 configuration



- Planter 3 configuration



- Planter 4 configuration



- Access to planter configuration setting



- Return to the previous menu

Configuration examples:

- 6-7 row planter

By default, configuration 1 corresponds to the full planter with 7 rows at 60 cm, configuration 2 corresponds to planter version with 6 rows at 75 cm.

- 6-8 row planter

- 6-9 row planter

- 8-9 row planter

- 8-12 row planter

☞ If any modifications are made to the configuration, the ECU asks to be restarted in order to take into account these modifications.

## NAVIGAZIONE MENU REGOLAZIONI GLOBALI

### ► Regolazioni delle seminatrici miste



- Configurazione seminatrice 1



- Configurazione seminatrice 1 attiva



- Configurazione seminatrice 2



- Configurazione seminatrice 3



- Configurazione seminatrice 4



- Accesso alle impostazioni della configurazione della seminatrice



- Ritorno al menu precedente

Esempi di configurazioni:

- Seminatrice 6-7 file

In modo predefinito, la configurazione 1 corrisponde alla seminatrice completa 7 file a 60 cm, la configurazione 2 corrisponde alla versione seminatrice 6 file a 75 cm.

- Seminatrice 6-8 file

- Seminatrice 6-9 file

- Seminatrice 8-9 file

- Seminatrice 8-12 file

☞ Per qualunque modifica apportata alla configurazione, occorre riavviare l'ECU per registrare le modifiche.

# MENU RÉGLAGES GLOBALES

Globale  
réglages

**REGLAGES GLOBAL**

Impulsions/100m: 10000

Impulsions/100m: 17700

Pos. trav. capteur: intern

9 (0-9)

1 (0-9)

20 s

Vitesse nominale: 8.0 km/h

180m

180m

Restart

**Task controller**

TC Client: MARCHE

X-Offset: 1.50 m

Y-Offset: 0.00 m

Connecteur arrière:

Allumer retard: 0.1 s

Éteindre retard: 0.1 s

1

2

3

4

5

6

Restart

**Task controller**

TC Client: ARRÊT

X-Offset: 1.50 m

Y-Offset: 0.00 m

Allumer retard: 0.1 s

Éteindre retard: 0.1 s

Le système doit être redémarré pour le transfert de données.

Restart

## NAVIGATION MENU RÉGLAGES GLOBAUX

### ► Réglages du contrôleur de tâches :



- Retour au menu précédent

### Descriptif de l'écran :

- ① - Activation de la fonction TC-SC pour l'ECU semoir
  - Fonction TS-SC sur arrêt
  - Fonction TS-SC sur marche côté ECU semoir uniquement
  - Fonction TS-SC active côté ECU semoir et terminal
- ② - Distance entre l'attelage du semoir et la chute de graine
- ③ - Décalage entre l'axe de semoir et l'axe du tracteur
- ④ - Activation du mode double ISO (semoir arrière et trémie avant)
- ⑤ - Réglage des temps de latence au départ (fonction TC-SC)
- ⑥ - Réglage des temps de latence à l'arrivée (fonction TC-SC)

☞ Pour toutes modifications apportées à la configuration, l'ECU demande à être redémarrer pour prendre en compte les modifications.

## NAVEGACIÓN MENÚ AJUSTES GLOBALES

### ► Ajustes del controlador de tareas:



- Vuelta al menú anterior

### Descripción de la pantalla:

- ① - Activación de la función TC-SC para el ECU sembradora
  - Función TS-SC en parada
  - Función TS-SC en marcha lado ECU sembradora solamente
  - Función TS-SC activa lado ECU sembradora y terminal
- ② - Distancia entre el enganche de la sembradora y la caída de grano
- ③ - Desfase entre el eje de la sembradora y el eje del tractor
- ④ - Activación del modo doble ISO (sembradora detrás y tolva delante)
- ⑤ - Ajuste de los tiempos de latencia a la salida (función TC-SC)
- ⑥ - Ajuste de los tiempos de latencia a la llegada (función TC-SC)

☞ Para todas modificaciones introducidas en la configuración, el ECU solicita ser reiniciado para tener en cuenta las modificaciones.

## GENERAL SETTINGS MENU NAVIGATION

### ► Task controller settings:



- Return to the previous menu

### Description of the screen:

- ① - Activation of the TC-SC function for the planter ECU
  - TS-SC function off
  - TS-SC function on, planter ECU side only
  - TS-SC function active, terminal and planter ECU side
- ② - Distance between the hitch of the planter and seed dispensing
- ③ - Distance between the axle of the planter and the axle of the tractor
- ④ - Activation of ISO double mode (planter at the back and hopper at the front)
- ⑤ - Setting delay time at the start (TC-SC function)
- ⑥ - Setting delay time at the end (TC-SC function)

☞ If any modifications are made to the configuration, the ECU asks to be restarted in order to take into account these modifications.

## NAVIGAZIONE MENU REGOLAZIONI GLOBALI

### ► Regolazioni del controllore di task:



- Ritorno al menu precedente

### Descrizione della schermata:

- ① - Attivazione della funzione TC-SC per l'ECU seminatrice
  - Funzione TS-SC su arresto
  - Funzione TS-SC su funzionamento soltanto lato ECU seminatrice
  - Funzione TS-SC attiva lato ECU seminatrice e terminale
- ② - Distanza tra l'attacco della seminatrice e la caduta di semi
- ③ - Spostamento tra l'asse della seminatrice e del trattore
- ④ - Attivazione del modo doppio ISO (seminatrice dietro e tramoggia davanti)
- ⑤ - Regolazione dei tempi di latenza all'avvio (funzione TC-SC)
- ⑥ - Regolazione dei tempi di latenza all'arrivo (funzione TC-SC)

☞ Per qualunque modifica apportata alla configurazione, occorre riavviare l'ECU per registrare le modifiche.

# MENU RÉGLAGES DU SEMOIR

Semoir réglages

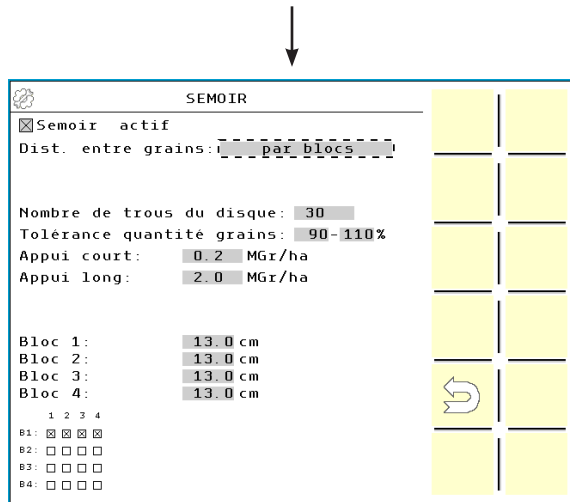
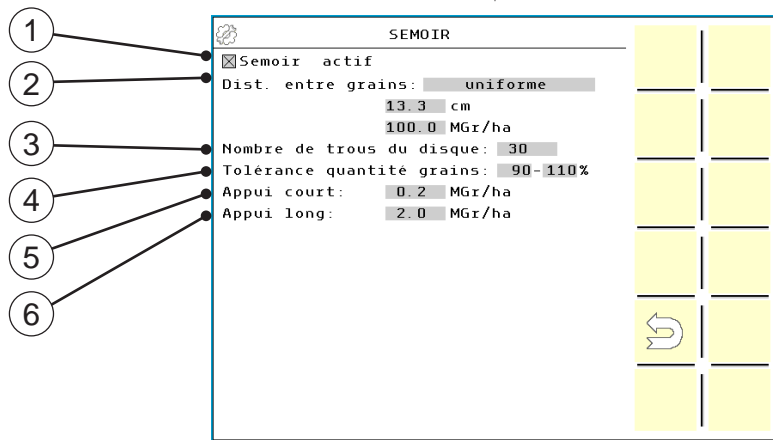
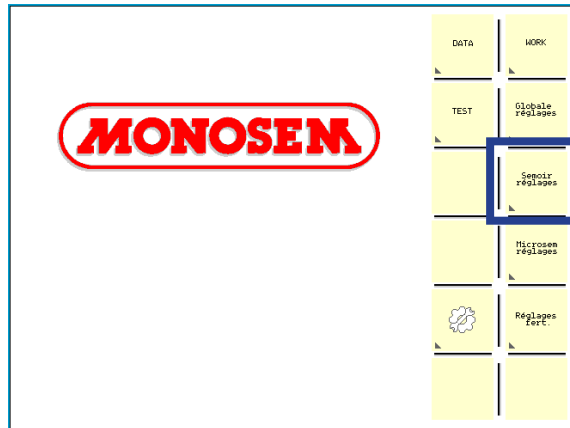

## NAVIGATION MENU RÉGLAGE DU SEMOIR



- Accès au menu réglage du semoir



- Retour au menu précédent

### ► Descriptif de l'écran :

- ① - Activation de la partie semoir
- ② - Distance entre graines et densité  
Uniforme : valeur identique pour l'ensemble du semoir  
Par blocs : valeur variable en fonction des blocs programmés  
Affichage en bas de page de la programmation des blocs (4 possibilités de variation)
- ③ - Nombre de trous du disque
- ④ - Réglage de la tolérance des alarmes de population
- ⑤ - Modification de la valeur de réglage pour l'appui court

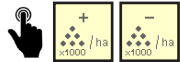

- ⑥ - Modification de la valeur de réglage pour l'appui long

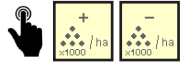

## NAVEGACIÓN MENÚ AJUSTE DE LA SEMBRADORA



- Acceso al menú de ajuste de la sembradora



- Vuelta al menú anterior

### ► Descripción de la pantalla:

- ① - Activación de la parte sembradora
- ② - Distancia entre granos y densidad  
Uniforme: valor idéntico para el conjunto de la sembradora  
Por bloques: valor variable en función de los bloques programados  
Visualización en la parte inferior de la página de la programación de los bloques (4 posibilidades de variación)
- ③ - Número de agujeros en el disco
- ④ - Ajuste de la tolerancia de las alarmas de población
- ⑤ - Modificación del valor de ajuste pulsando brevemente

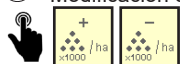

- ⑥ - Modificación del valor de ajuste pulsando brevemente



## PLANTER SETTING MENU NAVIGATION



- Access to planter setting menu



- Return to the previous menu

### ► Description of the screen:

- ① - Activation of planter section
- ② - Distance between seeds and density  
Uniform: value identical for the entire planter  
By units: value variable according to the units programmed  
Display at the bottom of the page of unit programming (4 variation possibilities)
- ③ - Number of disk holes
- ④ - Setting population alarm permissible variation
- ⑤ - Modifying setting value for short press



- ⑥ - Modifying setting value for long press

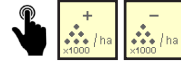

## NAVIGAZIONE MENU REGOLAZIONE DELLA SEMINATRICE



- Accesso al menu regolazione della seminatrice



- Ritorno al menu precedente

### ► Descrizione della schermata:

- ① - Attivazione della parte seminatrice
- ② - Distanza tra semi e densità  
Uniforme: valore identico per tutta la seminatrice  
Per blocchi: valore variabile a seconda dei blocchi programmati  
Visualizzazione nella parte inferiore della pagina di programmazione dei blocchi (4 possibilità di variazione)
- ③ - Numero di fori del disco
- ④ - Regolazione della tolleranza degli allarmi di popolazione
- ⑤ - Modifica del valore di regolazione tramite pressione breve

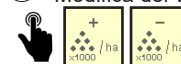

- ⑥ - Modifica del valore di regolazione tramite pressione breve



# MENU RÉGLAGES DU FERTILISEUR

Réglages  
fert.

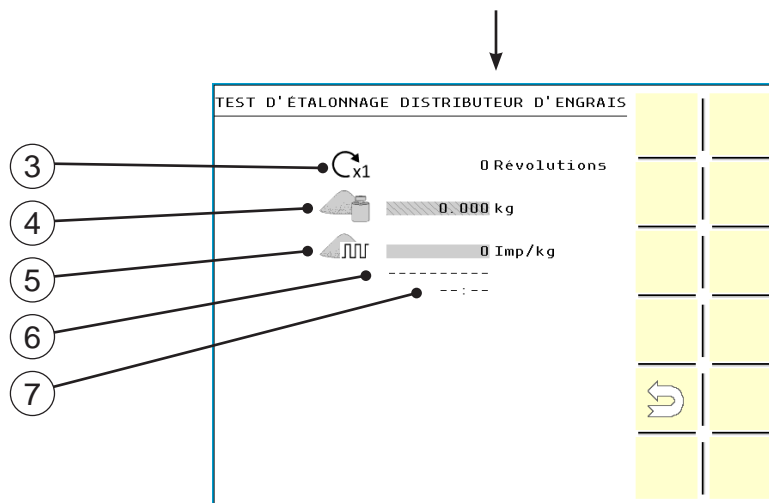
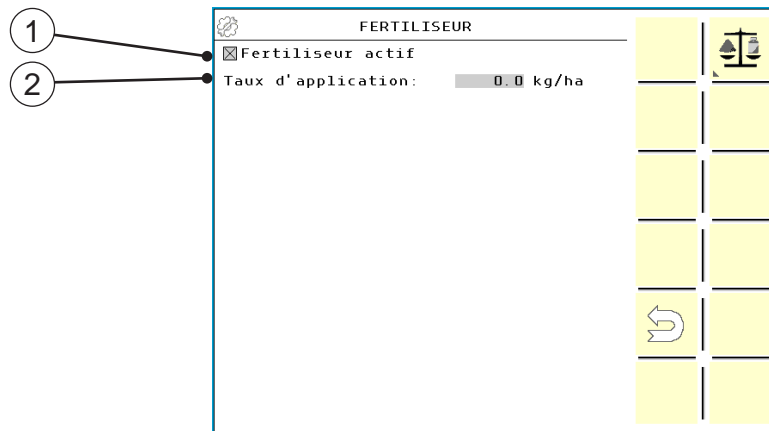
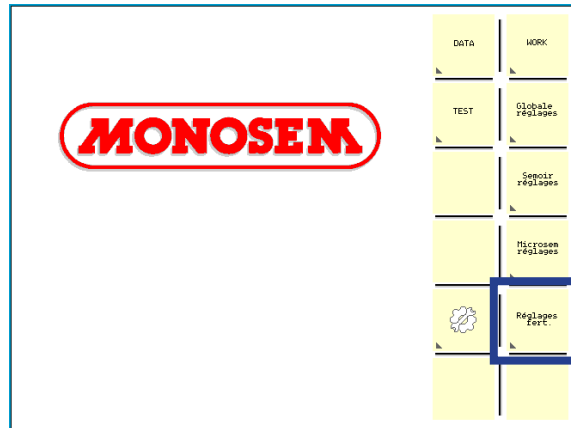



## NAVIGATION MENU RÉGLAGE FERTILISEUR



- Accès au menu réglage du fertiliseur



- Accès à l'étalonnage du fertiliseur



- Retour au menu précédent

### ► Descriptif de l'écran :

① - Activation de la rampe fertiliseur  
Si la rampe fertiliseur n'est pas activée, on ne peut pas l'utiliser.



- ② - Valeur de la dose d'engrais souhaité
- ③ - Nombre de révolution du moteur lors de l'étalonnage
- ④ - Poids du produit pesé sur une sortie
- ⑤ - Nombre d'impulsion trouvée lors de l'étalonnage
- ⑥ - Date du dernier étalonnage
- ⑦ - Heure du dernier étalonnage

## FERTILIZER PLACEMENT UNIT SETTING MENU NAVIGATION



- Access to fertilizer placement unit setting menu



- Access to fertilizer placement unit calibration



- Return to the previous menu

### ► Description of the screen:

① - Activation of fertilizer placement unit boom  
If the fertilizer placement unit boom is not activated, it cannot be used.



- ② - Value of fertilizer amount required
- ③ - Number of motor revolutions during calibration
- ④ - Weight of the product weighed at an outlet
- ⑤ - Number of impulses found during calibration
- ⑥ - Date of last calibration
- ⑦ - Time of last calibration

## NAVEGACIÓN MENÚ DE AJUSTE DEL FERTILIZADOR



- Acceso al menú de ajuste del fertilizador



- Acceso al calibrado del fertilizador



- Vuelta al menú anterior

### ► Descripción de la pantalla:

① - Activación de la rampa del fertilizador  
Si la rampa del fertilizador no está activada, no se puede utilizar.



- ② - Valor de la dosis de abono deseada
- ③ - Número de revoluciones del motor durante la calibración
- ④ - Peso del producto pesado en una salida
- ⑤ - Número de impulsión encontrada durante la calibración
- ⑥ - Fecha de la última calibración
- ⑦ - Hora de la última calibración

## NAVIGAZIONE MENU REGOLAZIONE FERTILIZZATORE



- Accesso al menu regolazione del fertilizzatore



- Accesso alla calibrazione del fertilizzatore



- Ritorno al menu precedente

### ► Descrizione della schermata:

① - Attivazione della rampa fertilizzatore  
Se la rampa fertilizzatore non è attivata, non la si può utilizzare.



- ② - Valore della dose di concime desiderata
- ③ - Numero di rivoluzione del motore durante la calibrazione
- ④ - Peso del prodotto pesato su un'uscita
- ⑤ - Numero di impulso rilevato durante la calibrazione
- ⑥ - Data dell'ultima calibrazione
- ⑦ - Ora dell'ultima calibrazione

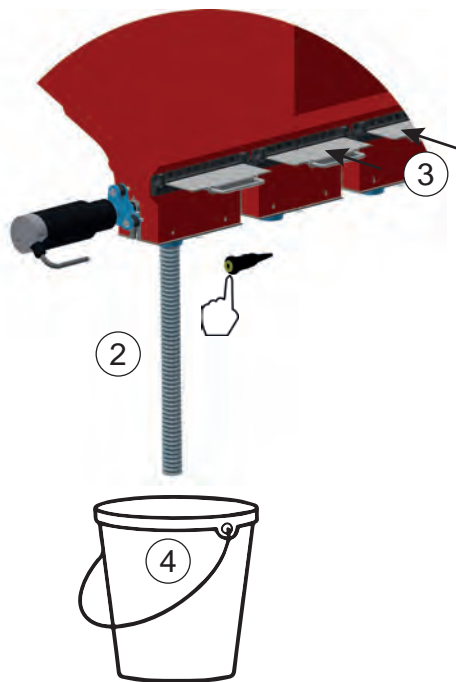
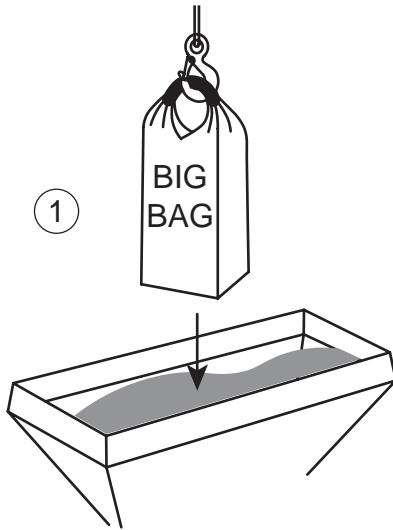

# MENU RÉGLAGES DU FERTILISEUR

Réglages fert.



5  Accès menu



6  Pré-charge 5 s  
 Vider le seau

7  Etalonnage 1 min 30 s

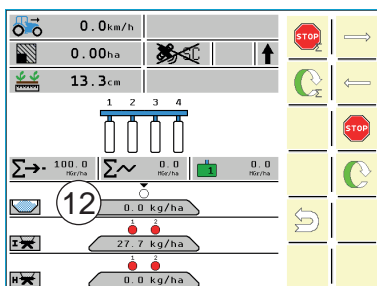
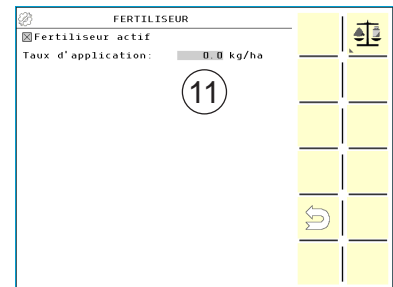
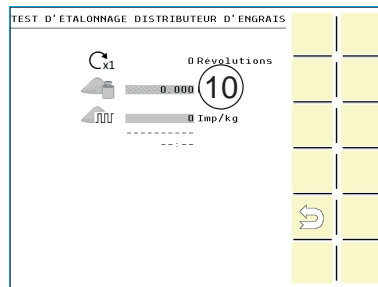
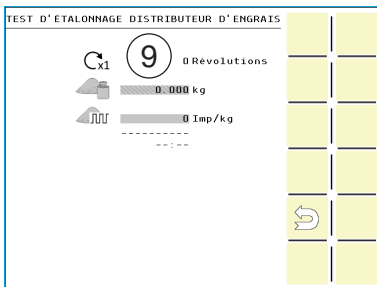
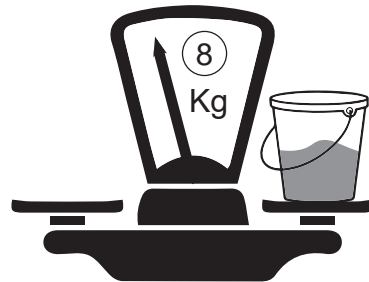

## NAVIGATION MENU RÉGLAGE FERTILISEUR

### ► Procédure d'étalonnage du produit :

- ①- Remplir la trémie avec de l'engrais.
- ②- Déconnecter le tuyau.
- ③- Fermer les trappes sur les autres sorties.
- ④- Placer un seau en dessous.
- ⑤- Appuyer sur le bouton d'étalonnage afin d'accéder à la page de calibration.
- ⑥- Effectuer une précharge pour remplir le boîtier de distribution en appuyant sur le bouton pendant 5 secondes environ.  
Ne pas oublier de vider le seau après cette manipulation.
- ⑦- Lancer l'étalonnage, appuyer sur le bouton pendant 1 minute et 30 secondes.
- ⑧- Prendre le seau et peser l'engrais récupéré lors de l'étalonnage.
- ⑨- Affichage du nombre de révolution lors de l'étalonnage.
- ⑩- Entrer la valeur pesée.
- ⑪- Entrer la dose d'engrais souhaité.
- ⑫- La dose cible s'affiche sur l'écran de travail.

 Plusieurs paramètres peuvent faire varier les débits (granulométrie, hygrométrie...). Ils sont à vérifier obligatoirement sur le terrain par un essai préalable afin de pouvoir rectifier le réglage, si nécessaire, pour obtenir réellement la dose/hectare désirée.  
RIBOULEAU MONOSEM décline toute responsabilité dans le réglage du débit qui reste à l'appréciation de l'utilisateur.

 Entretien en fin de journée :  
- Vidanger la trémie à l'aide des trappes.  
- Contrôler l'alignement des boîtiers de distribution.  
- Fermer les 8 trappes de la trémie pour vidanger les boîtiers de distribution, faire tourner la turbine pour évacuer l'engrais dans les tuyaux pulsés. Au matin faire tourner la turbine pour sécher les tuyaux d'engrais.

## NAVEGACIÓN MENÚ DE AJUSTE DEL FERTILIZADOR

### ► Método de calibrado del producto:

- ①- Llenar la tolva con el abono.
- ②- Desconectar el tubo.
- ③- Cerrar las trampillas en las otras salidas.
- ④- Colocar un cubo debajo.
- ⑤- Pulsar el botón de calibración para acceder a la página de calibración.
- ⑥- Realizar una precarga para llenar la caja de distribución pulsando el botón durante 5 segundos.  
No olvidar vaciar el cubo después de esta manipulación.
- ⑦- Lanzar el calibrado, pulsar el botón de calibrado durante 1 minuto y 30 segundos.
- ⑧- Coger el cubo y pesar el abono recuperado durante el calibrado.
- ⑨- Visualización del número de revoluciones durante la calibración.
- ⑩- Introducir el valor pesado.
- ⑪- Introducir la dosis de abono deseada.
- ⑫- La dosis objetivo se visualiza en la pantalla de trabajo.

 Varios son los parámetros que pueden hacer variar los caudales (granulometría, higrometría...). Deberán verificarse obligatoriamente sobre el terreno mediante una prueba previa con el fin de poder rectificar el ajuste, si es necesario, para obtener realmente la dosis/hectárea deseada.

RIBOULEAU MONOSEM declina toda responsabilidad en el ajuste del caudal, que quedará a la apreciación del usuario.

 Mantenimiento al final del día:  
- Vaciar la tolva a través de las trampillas.  
- Controlar la alineación de las cajas de distribución.  
- Cerrar las 8 trampillas de la tolva para vaciar las cajas de distribución, hacer girar la turbina para evacuar el abono en los tubos pulsados. Por la mañana, hacer girar la turbina para secar los tubos de abono.

## FERTILIZER PLACEMENT UNIT SETTING MENU NAVIGATION

### ► Product calibration procedure:

- ①- Fill the hopper with fertilizer.
- ②- Disconnect the pipe.
- ③- Close the traps on the other outlets.
- ④- Place a bucket underneath.
- ⑤- Press the calibration button in order to access the calibration page.
- ⑥- Carry out a pre-load to fill the metering box by pressing the button for approximately 5 seconds.  
Do not forget to empty the bucket after this procedure.
- ⑦- Launch calibration, press the calibration button for 1 minute 30 seconds.
- ⑧- Take the bucket and weigh the fertilizer collected during calibration.
- ⑨- Number of revolutions during calibration display.
- ⑩- Enter the value weighed.
- ⑪- Enter the amount of fertilizer required.
- ⑫- The target amount is displayed on the work screen.

 Several parameters can cause flow rates to vary (grain size, humidity ...). They must be checked in the field via a prior test in order to be able to change the setting, if necessary, and obtain the actual amount/hectare required.  
RIBOULEAU MONOSEM shall not be held responsible for the flow rate setting, which is at the user's discretion.

 Maintenance at the end of the day:  
- Empty the hopper via the traps.  
- Check the alignment of the metering boxes.  
- Close the 8 hopper traps to empty the metering boxes, make the turbine rotate to remove the fertilizer in the forced air pipes. In the morning, make the turbine rotate to dry the fertilizer pipes.

## NAVIGAZIONE MENU REGOLAZIONE FERTILIZZATORE

### ► Procedura di taratura del prodotto:

- ①- Riempire la tramoggia con il concime.
- ②- Scollegare il tubo.
- ③- Chiudere le botole sulle altre uscite.
- ④- Mettere un secchio sotto.
- ⑤- Premere il pulsante di calibrazione per accedere alla pagina di calibrazione.
- ⑥- Effettuare una precarica per riempire la scatola di distribuzione premendo il pulsante per circa 5 secondi.  
Non dimenticare di svuotare il secchio dopo questa manipolazione.
- ⑦- Avviare la calibrazione, premere il pulsante di taratura per 1 minuto e 30 secondi.
- ⑧- Prendere il secchio e pesare il concime recuperato durante la calibrazione.
- ⑨- Visualizzazione del numero di rivoluzioni durante la calibrazione.
- ⑩- Inserire il valore pesado.
- ⑪- Inserire la dose di concime desiderata.
- ⑫- La dose target appare sul display di lavoro.

 Vari parametri possono fare variare le portate (granulometria, igrometria, ...). Devono essere controllati tassativamente in campo tramite una prova preliminare in modo tale da correggere la regolazione, se necessario, per ottenere realmente la dose per ettaro desiderata.  
RIBOULEAU MONOSEM declina ogni responsabilità nella regolazione della portata che resta a discrezione dell'utente.

 Manutenzione di fine giornata:  
- Svuotare la tramoggia dalle botole.  
- Controllare l'allineamento delle scatole di distribuzione.  
- Chiudere le 8 botole della tramoggia per svuotare le scatole di distribuzione, fare girare la turbina per scaricare il concime nei tubi pulsati. Al mattino, fare girare la turbina per asciugare i tubi di concime.

# MENU RÉGLAGES DU MICROSEM

Microsem  
réglages

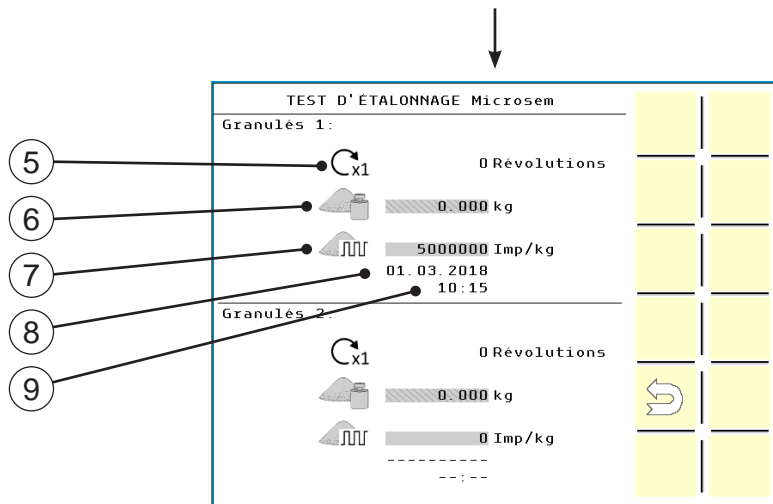
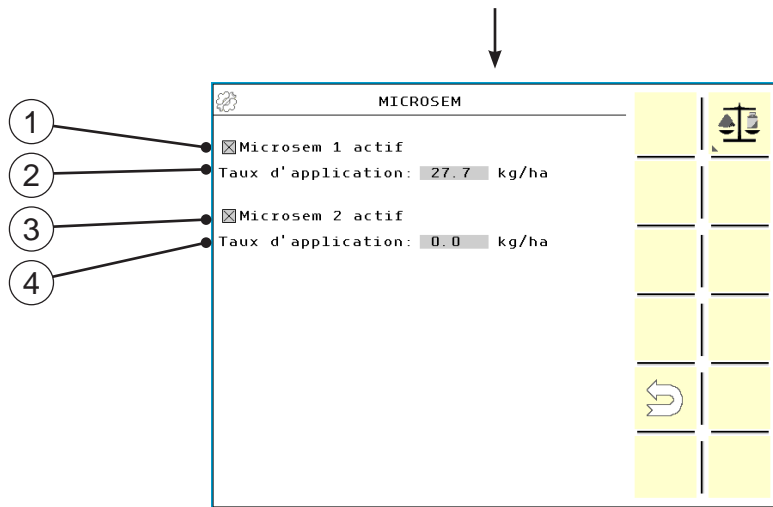
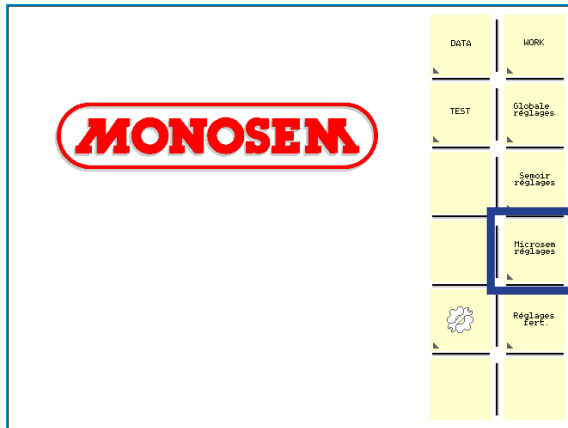

## NAVIGATION MENU RÉGLAGE MICROSEM



- Accès au menu réglage du Microsem



- Accès à l'étalonnage du Microsem



- Retour au menu précédent

### ► Descriptif de l'écran :

① - Activation de la rampe Microsem 1  
Si la rampe Microsem 1 n'est pas activée, on ne peut pas l'utiliser.



② - Valeur de la dose de produit souhaité pour la rampe 1

③ - Activation de la rampe Microsem 2  
Si la rampe Microsem 2 n'est pas activée, on ne peut pas l'utiliser.



④ - Valeur de la dose de produit souhaité pour la rampe 2

⑤ - Nombre de révolution du moteur lors de l'étalonnage

⑥ - Poids du produit pesé sur une sortie

⑦ - Nombre d'impulsion trouvée lors de l'étalonnage

⑧ - Date du dernier étalonnage

⑨ - Heure du dernier étalonnage

## NAVEGACIÓN MENÚ AJUSTE MICROSEM



- Acceso al menú de ajuste de Microsem



- Acceso al calibrado de Microsem



- Vuelta al menú anterior

### ► Descripción de la pantalla:

① - Activación de la rampa Microsem 1  
Si la rampa Microsem 1 no está activada, no se puede utilizar.



② - Valor de la dosis de producto deseada para la rampa 1

③ - Activación de la rampa Microsem 2  
Si la rampa Microsem 2 no está activada, no se puede utilizar.



④ - Valor de la dosis de producto deseada para la rampa 2

⑤ - Número de revoluciones del motor durante la calibración

⑥ - Peso del producto pesado en una salida

⑦ - Número de impulsión encontrada durante la calibración

⑧ - Fecha de la última calibración

⑨ - Hora de la última calibración

## MICROSEM SETTING MENU NAVIGATION



- Access to Microsem setting menu



- Access to Microsem calibration



- Return to the previous menu

### ► Description of the screen:

① - Activation of Microsem 1 boom  
If the Microsem 1 boom is not activated, it cannot be used.



② - Value of product amount required for boom 1

③ - Activation of Microsem 2 boom  
If the Microsem 2 boom is not activated, it cannot be used.



④ - Value of the product amount required for boom 2

⑤ - Number of motor revolutions during calibration

⑥ - Weight of product weighed at an outlet

⑦ - Number of impulses found during calibration

⑧ - Date of last calibration

⑨ - Time of last calibration

## NAVIGAZIONE MENU REGOLAZIONE MICROSEM



- Accesso al menu regolazione del Microsem



- Accesso alla calibrazione del Microsem



- Ritorno al menu precedente

### ► Descrizione della schermata:

① - Attivazione della rampa Microsem 1  
Se la rampa Microsem 1 non è attivata, non la si può utilizzare.



② - Valore della dose di prodotto desiderata per la rampa 1

③ - Attivazione della rampa Microsem 2  
Se la rampa Microsem 2 non è attivata, non la si può utilizzare.



④ - Valore della dose di prodotto desiderata per la rampa 2

⑤ - Numero di rivoluzione del motore durante la calibrazione

⑥ - Peso del prodotto pesato su un'uscita

⑦ - Numero di impulso rilevato durante la calibrazione

⑧ - Data dell'ultima calibrazione

⑨ - Ora dell'ultima calibrazione

# MENU RÉGLAGES DU MICROSEM

Microsem réglages



4   
 Accès menu

5   
 Pré-charge 5 s   
 Vider le seau

6   
 Etalonnage 1 min 30 s

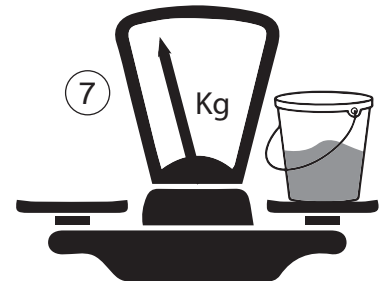

8   
 Quantité pesée pour deux sorties   
 Poids pour une sortie   
 Valeur à retenir pour le test

TEST D'ÉTALONNAGE Microsem			
Granules 1:			
	0.000 kg		
	5000000 Imp/kg		
	01.03.2018 10:15		
Granules 2:			
	0.000 kg		
	0 Imp/kg		

TEST D'ÉTALONNAGE Microsem			
Granules 1:			
	0.000 kg		
	5000000 Imp/kg		
	01.03.2018 10:15		
Granules 2:			
	0.000 kg		
	0 Imp/kg		

MICROSEM			
<input checked="" type="checkbox"/>	Microsem 1 actif		
	Taux d'application: 27.7 kg/ha		
<input checked="" type="checkbox"/>	Microsem 2 actif		
	Taux d'application: 0.0 kg/ha		

0.0 km/h

0.00 ha

13.3 cm

1 2 3 4

100.0 kg/ha

0.0 kg/ha

27.7 kg/ha

0.0 kg/ha



## NAVIGATION MENU RÉGLAGE MICROSEM

### ► Procédure d'étalonnage du produit :

- ①- Remplir la trémie avec du produit.
- ②- Déconnecter les tuyaux.
- ③- Placer un seau en dessous.
- ④- Appuyer sur le bouton afin d'accéder à la page d'étalonnage.
- ⑤- Effectuer une précharge pour remplir le boîtier de distribution en appuyant sur le bouton pendant 5 secondes environ. Ne pas oublier de vider le seau après cette manipulation.
- ⑥- Lancer l'étalonnage, appuyer sur le bouton pendant 1 minute et 30 secondes.
- ⑦- Prendre le seau et peser le produit récupéré lors de l'étalonnage.
- ⑧- Diviser le poids par deux pour avoir la valeur sur une sortie.
- ⑨- Affichage du nombre de révolution lors de l'étalonnage.
- ⑩- Entrer la valeur pesée.
- ⑪- Entrer la dose de produit souhaitée.
- ⑫- La dose cible s'affiche sur l'écran de travail.

 Plusieurs paramètres peuvent faire varier les débits (granulométrie, hygrométrie, ...). Ils sont à vérifier obligatoirement sur le terrain par un essai préalable afin de pouvoir rectifier le réglage, si nécessaire, pour obtenir réellement la dose/hectare désirée.

RIBOULEAU MONOSEM décline toute responsabilité dans le réglage du débit qui reste à l'appréciation de l'utilisateur.

 Entretien en fin de journée :

- Vidanger les trémies à l'aide des trappes.
- Contrôler l'alignement des boîtiers de distribution.
- Fermer les 8 trappes de la trémie pour vidanger les boîtiers de distribution, faire tourner la turbine pour évacuer l'engrais dans les tuyaux pulsés. Au matin faire tourner la turbine pour sécher les tuyaux d'engrais.

## NAVEGACIÓN MENÚ AJUSTE MICROSEM

### ► Método de calibrado del producto:

- ①- Llenar la tolva con el producto.
- ②- Desconectar los tubos.
- ③- Colocar un cubo debajo.
- ④- Pulsar el botón de calibración para acceder a la página de calibración.
- ⑤- Realizar una precarga para llenar la caja de distribución pulsando el botón durante 5 segundos. No olvidar vaciar el cubo después de esta manipulación.
- ⑥- Lanzar el calibrado, pulsar el botón de calibrado durante 1 minuto y 30 segundos.
- ⑦- Coger el cubo y pesar el abono recuperado durante el calibrado.
- ⑧- Dividir el peso por dos para tener el valor en una salida.
- ⑨- Visualización del número de revoluciones durante la calibración.
- ⑩- Introducir el valor pesado.
- ⑪- Introducir la dosis de abono deseada.
- ⑫- La dosis objetivo se visualiza en la pantalla de trabajo.

 Varios son los parámetros que pueden hacer variar los caudales (granulometría, higrometría...). Deberán verificarse obligatoriamente sobre el terreno mediante una prueba previa con el fin de poder rectificar el ajuste, si es necesario, para obtener realmente la dosis/hectárea deseada.

RIBOULEAU MONOSEM declina toda responsabilidad en el ajuste del caudal, que quedará a la apreciación del usuario.

 Mantenimiento al final del día:

- Vaciar la tolva a través de las trampillas.
- Controlar la alineación de las cajas de distribución.
- Cerrar las 8 trampillas de la tolva para vaciar las cajas de distribución, hacer girar la turbina para evacuar el abono en los tubos pulsados. Por la mañana, hacer girar la turbina para secar los tubos de abono.

## MICROSEM SETTING MENU NAVIGATION

### ► Product calibration procedure:

- ①- Fill the hopper with product.
- ②- Disconnect the pipes.
- ③- Place a bucket underneath.
- ④- Press the calibration button in order to access the calibration page.
- ⑤- Carry out a pre-load to fill the metering box by pressing the button for approximately 5 seconds. Do not forget to empty the bucket after this procedure.
- ⑥- Launch calibration, press the calibration button for 1 minute and 30 seconds.
- ⑦- Take the bucket and weigh the fertilizer collected during calibration.
- ⑧- Divide the weight by two in order to obtain the value at an outlet.
- ⑨- Number of revolutions during calibration display.
- ⑩- Enter the value weighed.
- ⑪- Enter the amount of fertilizer required.
- ⑫- The target amount is displayed on the work screen.

 Several parameters can cause the flow rates to vary (grain size, humidity ...). They must be checked in the field via a prior test in order to be able to change the setting, if necessary, and obtain the actual amount/hectare required.

RIBOULEAU MONOSEM shall not be held responsible for the setting of the flow rate, which is at the user's discretion.

 Maintenance at the end of the day:

- Empty the hoppers via the traps.
- Check the alignment of the metering boxes.
- Close the 8 hopper traps to empty the metering boxes, make the turbine rotate to remove the fertilizer in the forced air pipes. In the morning, make the turbine rotate to dry the fertilizer pipes.

## NAVIGAZIONE MENU REGOLAZIONE MICROSEM

### ► Procedura di taratura del prodotto:

- ①- <sup>2</sup>Riempire la tramoggia con il prodotto.
- ②- Scollegare i tubi.
- ③- Mettere un secchio sotto.
- ④- Premere il pulsante di calibrazione per accedere alla pagina di calibrazione.
- ⑤- Effettuare una precarica per riempire la scatola di distribuzione premendo il pulsante per circa 5 secondi. Non dimenticare di svuotare il secchio dopo questa manipolazione.
- ⑥- Avviare la calibrazione, premere il pulsante di taratura per 1 minuto e 30 secondi.
- ⑦- Prendere il secchio e pesare il concime recuperato durante la calibrazione.
- ⑧- Dividere il peso per due per avere il valore di un'uscita.
- ⑨- Visualizzazione del numero di rivoluzioni durante la calibrazione.
- ⑩- Inserire il valore pesato.
- ⑪- Inserire la dose di concime desiderata.
- ⑫- La dose target appare sul display di lavoro.

 Vari parametri possono fare variare le portate (granulometria, igrometria, ...). Devono essere controllati tassativamente in campo tramite una prova preliminare in modo tale da correggere la regolazione, se necessario, per ottenere realmente la dose per ettaro desiderata. RIBOULEAU MONOSEM declina ogni responsabilità nella regolazione della portata che resta a discrezione dell'utente.

 Manutenzione di fine giornata:

- Svuotare la tramoggia dalle botole.
- Controllare l'allineamento delle scatole di distribuzione.
- Chiudere le 8 botole della tramoggia per svuotare le scatole di distribuzione, fare girare la turbina per scaricare il concime nei tubi pulsati. Al mattino, fare girare la turbina per asciugare i tubi di concime.

# MENU RÉGLAGES DU MICROSEM

Microsem  
réglages

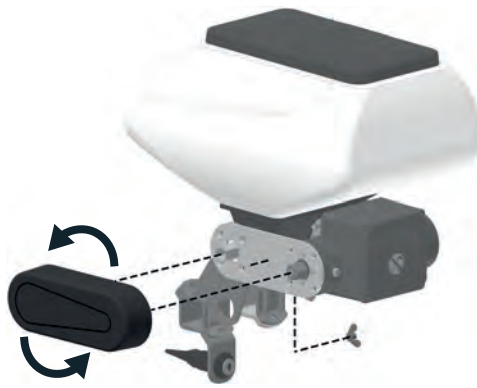
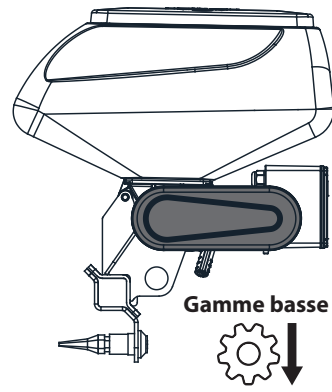
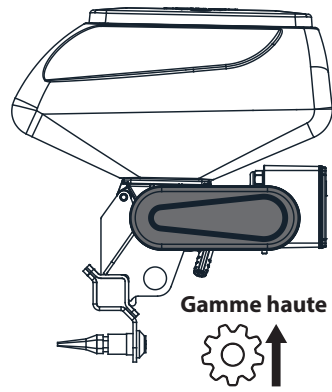

## NAVIGATION MENU RÉGLAGE MICROSEM

### ► Changement de gamme :

Si la valeur souhaitée (kg/ha) ne rentre pas dans la plage de réglage, effectuez un changement de gamme et **refaire l'étalonnage du produit**.

Gamme haute : grande poulie en bout d'arbre du moteur  
Gamme basse : petite poulie en bout d'arbre du moteur

Rapport de 4,8 entre les deux gammes.

### ► Changement de gamme rapide :

- ① - Dévisser l'écrou papillon.
- ② - Retirer le boîtier de transmission.
- ③ - Faire un demi-tour au niveau du boîtier.
- ④ - Repositionner le boîtier en alignant les axes 6 pans.
- ⑤ - Resserrer l'écrou papillon.

## NAVEGACIÓN MENÚ AJUSTE MICROSEM

### ► Cambio de gama:

Si el valor deseado (kg/ha) no entra en el margen de ajuste, efectuar un cambio de gama y volver a calibrar el producto.

Gama alta: polea grande en el extremo del árbol del motor  
Gama baja: polea pequeña en el extremo del árbol del motor

Relación de 4,8 entre ambas gamas.

### ► Cambio de gama rápida:

- ① - Quitar la tuerca de mariposa.
- ② - Retirar la caja de transmisión.
- ③ - Hacer una media vuelta en la caja.
- ④ - Volver a colocar la caja alineando los ejes hexagonales.
- ⑤ - Volver a colocar la tuerca de mariposa.

## MICROSEM SETTING MENU NAVIGATION

### ► Range change:

If the value required (kg/ha) does not fall within in the adjustment range, change range and **re-calibrate the product**.

High range: large pulley at the end of the motor shaft  
Low range: small pulley at the end of the motor shaft

Ratio of 4.8 between the two ranges.

### ► Rapid range change:

- ① - Unscrew the butterfly nut.
- ② - Remove the gearbox casing.
- ③ - Perform a half turn at the level of the casing.
- ④ - Reposition the casing by aligning the hexagonal shafts.
- ⑤ - Tighten the butterfly nut.

## NAVIGAZIONE MENU REGOLAZIONE MICROSEM

### ► Cambio di gamma:

Se il valore desiderato (kg/ha) non rientra nella fascia di regolazione, cambiare gamma e rifare la taratura del prodotto.

Gamma alta: tramoggia grande all'estremità dell'albero del motore  
Gamma bassa: tramoggia piccola all'estremità dell'albero del motore

Rapporto di 4,8 tra le due gamme.

### ► Cambio rapido di gamma:

- ① - Svitare il dado a farfalla.
- ② - Rimuovere la scatola di trasmissione.
- ③ - Fare mezzo giro all'altezza della scatola.
- ④ - Riposizionare la scatola allineando i sei assi esagonali.
- ⑤ - Ristringere il dado a farfalla.

# ACTIVATION DES LICENCES

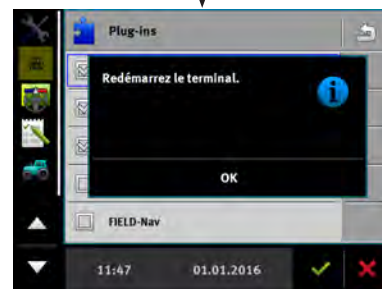
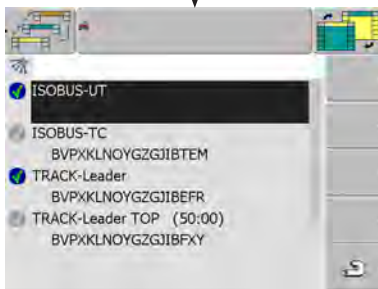
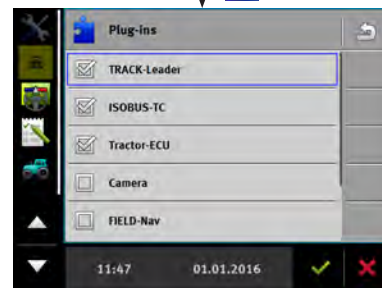
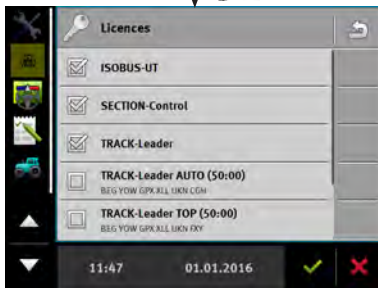
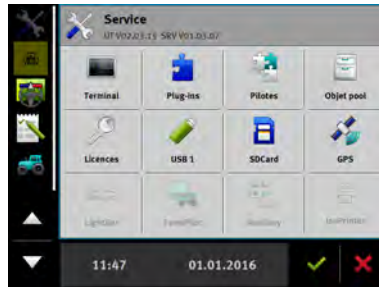

► **Activation et gestion des licences :**

Dans le menu « Gestionnaire des licences », vérifier si les deux licences sont activées :

- TRACK-Leader II
- SECTION-Control

Dans le menu « Paramètres Plugin », vérifier si les deux logiciels sont activés :

- ISOBUS-TC
- TRACK-Leader



La fonction est activée



La fonction est désactivée

**Après l'activation des logiciels, il est nécessaire de redémarrer la console.**

► **Licence activation and management :**

In the "Licenses menu", check whether or not the two licences have been activated:

- TRACK-Leader II
- SECTION-Control

In the "Plug-ins" menu, check whether or not the two pieces of software have been activated:

- ISOBUS-TC
- TRACK-Leader



The function is activated



The function is disabled

**After activating the software, it is necessary to restart the console.**

► **Activación y gestión de las licencias:**

En el menú «Gestor de licencias», comprobar si ambas licencias están activadas:

- TRACK-Leader II
- SECTION-Control

En el menú «Parámetros Plugin», comprobar si ambos programas de software están activados:

- ISOBUS-TC
- TRACK-Leader



La función está activada



La función está desactivada

**Después de la activación de los programas, es necesario reiniciar la consola.**

► **Attivazione e gestione delle licenze:**

Nel menu «Manager delle licenze», controllare che le due licenze siano attivate:

- TRACK-Leader II
- SECTION-Control

Nel menu «Impostazioni Plugin», controllare che le due licenze siano attivate:

- ISOBUS-TC
- TRACK-Leader



La funzione è attivata



La funzione è disattivata

**Dopo l'attivazione dei software, occorre riavviare la console.**

# ACTIVATION DU MODE GPS

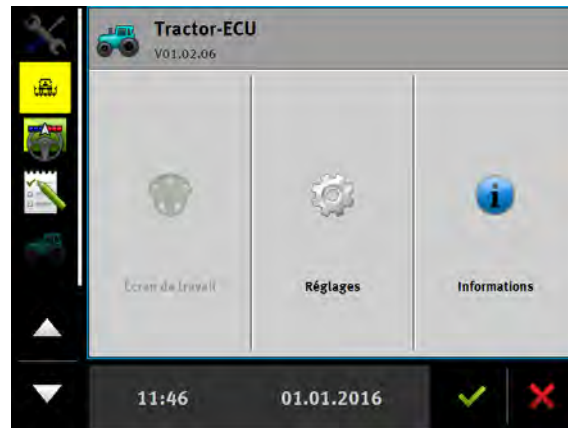

► **Activation et réglage du mode GPS :**

**Positionnement de l'antenne GPS sur le tracteur**

Dans le menu « Tractor-ECU », paramétrer la position de l'antenne. Indiquer les valeurs en X et Y entre l'antenne et le milieu de l'attelage inférieur.



**Avant de brancher l'antenne GPS sur la console, il faut absolument éteindre la console.**

**Si celle-ci est allumée, l'éteindre et patienter minimum 15 secondes avant de brancher l'antenne GPS.**

► **Activación y ajuste del modo GPS:**

**Colocación de la antena GPS en el tractor**

En el menú «Tractor-ECU», configurar la posición de la antena. Indicar los valores en X e Y entre la antena y el medio del enganche inferior.



**Antes de conectar la antena GPS en la consola, hay que apagar siempre la consola.**

**Si está encendida, apagarla y esperar como mínimo 15 segundos antes de conectar la antena GPS.**

► **Activating and setting the GPS mode:**

**Positioning the GPS antenna on the tractor**

In the "Tractor-ECU" menu set the position of the antenna. Indicate the values in X and Y between the antenna and the centre of the lower hitch.



**Before connecting the GPS antenna to the console, it is essential to switch off the console.**

**If it is switched on, switch it off and wait at least 15 seconds before connecting the GPS antenna.**

► **Attivazione e regolazione del modo GPS:**

**Posizionamento dell'antenna GPS sul trattore**

Nel menu «Tractor-ECU», impostare la posizione dell'antenna. Indicare i valori in X e Y tra l'antenna e il centro dell'attacco inferiore.



**Prima di allacciare l'antenna GPS sulla console, occorre assolutamente spegnere la consola.**

**Se questa è accesa, spegnerla e attendere minimo 15 secondi prima di allacciare l'antenna GPS.**



# ACTIVATION DU MODE SECTION CONTROL

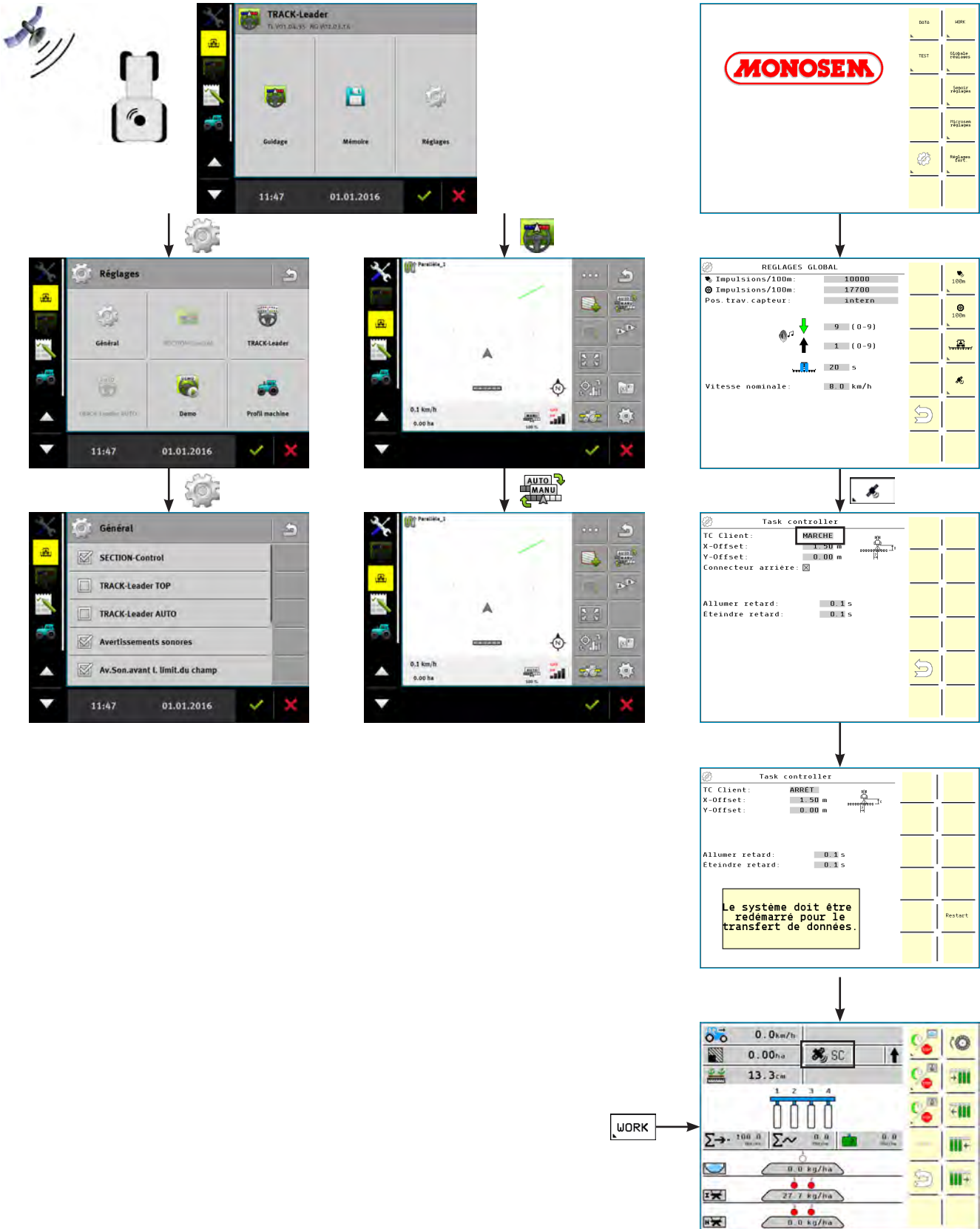

► **Autorisation du mode SECTION Control « SC »**

Dans le menu « TRACK-Leader », puis dans réglage, activé la fonction SECTION Control par « oui ».

Dans le menu « gestion semoir » :

Mettre en marche la fonction SECTION Control.

Indiquer les valeurs en X et Y entre le point de chute des graines et le milieu de l'attelage inférieur.

Dans le menu « WORK », vérifier que l'icône  est active.

**Activation du mode SECTION Control « SC »**

Dans le menu « TRACK-Leader », puis dans guidage, activer la fonction SECTION Control par « auto ».

► **Autorización del modo SECTION Control «SC»**

En el menú «TRACK-Leader», y después en ajuste, activar la función SECTION Control mediante «sí».

En el menú «gestión de la sembradora»:

Poner en marcha la función SECTION Control.

Indicar los valores en X e Y entre el punto de caída de las semillas y el medio del enganche inferior.

En el menú «WORK», comprobar que el icono  está activo.

**Activación del modo SECTION Control «SC»**

En el menú «TRACK-Leader», después en guía, activar la función SECTION Control mediante «auto».

► **Authorisation of the "SC" SECTION Control mode**

In the "TRACK-Leader" menu, then in settings, activate the SECTION Control function by selecting "yes".

In the "main menu":

Start the SECTION Control function.

Indicate the values in X and Y between the seed dispensing point and the centre of the lower hitch.

In the "WORK" menu, check that the  icon is active.

**Activation of the "SC" SECTION Control mode**

In the "TRACK-Leader" menu, then in navigation, activate the SECTION Control function by selecting "auto".

► **Autorizzazione del modo SECTION Control «SC»**

Nel menu «TRACK-Leader», quindi nella regolazione, attivare la funzione SECTION Control tramite «sì».

Nel menu «gestione seminatrice»:

Attivare la funzione SECTION Control.

Indicare i valori in X e Y tra il punto di caduta dei semi e il centro dell'attacco inferiore.

Nel menu «WORK», controllare che l'icona  sia attiva.

**Attivazione del modo SECTION Control «SC»**

Nel menu «TRACK-Leader», quindi nella guida, attivare la funzione SECTION Control tramite «auto».

## LISTE DES ALARMES

- ①- Description de l'alarme
- ②- Numéro d'alarme
- ③- Localisation des pannes

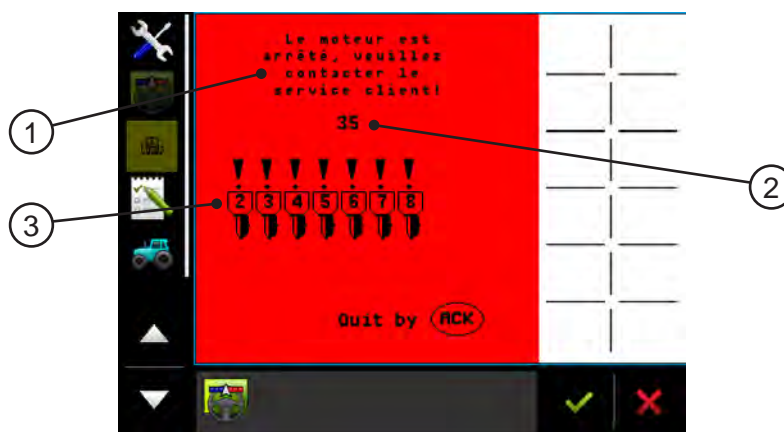

Code alarme	Cause possible	Actions correctives
31	Alimentation ECU <10v	1- Vérifier les fils d'alimentation ISOBUS et les fusibles. Se référer à la notice tracteur.
32	Tension d'alimentation régulée des capteurs <5v	1- vérifier la continuité des fils de capteur. 2- Vérifier les capteurs.
33	Tension d'alimentation non régulée des capteurs <12v	1- vérifier la continuité des fils de capteur. 2- Vérifier les capteurs.
34	Signal de vitesse incorrect	1- Vérifier la connection du signal de vitesse sur l'ECU moteur.
35	Pas de communication avec les ECU moteurs	1- Vérifier la connection LIN de l'ECU moteur. 2- Faire une mise à jour manuelle de l'ECU moteur si la LED de l'ECU moteur ne clignote pas régulièrement. 3- Remplacer l'ECU moteur.
36	Pas de communication avec le distributeur LIN.	1- Vérifier la connection entre les 2 cartes PCB de l'ECU principal. 2- Faire une mise à jour manuelle du distributeur LIN. 3- Remplacer l'ECU principal.
37	Coupure d'alimentation sur la ligne moteur.	1- Vérifier la connection entre le moteur et l'ECU moteur. 2- Vérifier l'alimentation du moteur sur l'ECU moteur. 3- Vérifier les fusibles sur le distributeur LIN.
38	Alimentation ISOBUS <12v.	1- Vérifier les fils d'alimentation ISOBUS et les fusibles. Se référer à la notice tracteur.
39	Disque ou moteur bloqué.	1- Vérifier que le disque/moteur tourne librement. 2- Vérifier la connection du codeur entre le moteur et l'ECU moteur. 3- Remplacer le moteur.
310	Vitesse trop élevée : le moteur à atteint la limite haute de rotation.	1- Réduire la vitesse de travail. 2- Vérifier la constante de vitesse. 3- Vérifier sur 100m. 4- Contrôler le radar.
311	Surcharge moteur.	1- Vérifier que le disque/moteur tourne librement. 2- Remplacer le moteur. 3- Remplacer l'ECU moteur.
312	Erreur de contrôle moteur ou défaut température.	1- Vérifier que le disque/moteur tourne librement. 2- Remplacer l'ECU moteur.
313	Erreur logiciel sur l'ECU moteur.	1- Faire une mise à jour manuelle de l'ECU moteur. 2- Remplacer l'ECU moteur.
314	Défaut d'alimentation codeur.	1- Vérifier la continuité des fils du codeur. 2- Remplacer l'ECU moteur. 3- Remplacer le moteur.
315	Défaut bus LIN.	1- Vérifier la continuité du fil LIN de l'ECU moteur. 2- Remplacer l'ECU principal.
316	Défaut d'alimentation DUO power.	1- Vérifier la tension de l'ECU principal. 2- Vérifier les fusibles.
317	Erreur logiciel sur distributeur LIN.	1- Faire une mise à jour manuelle du distributeur LIN. 2- Remplacer l'ECU principal.
318	Rang désactivé.	1- Informer que certains rangs sont désactivés.
319	Trémie vide.	1- Vérifier le niveau de la trémie. 2- Vérifier la cellule et les connections. 3- Remplacer la cellule. 4- Remplacer l'ECU moteur.

## LISTE DES ALARMES

Code alarme	Cause possible	Actions correctives
320	Trop peu de graine - manque.	1- Vérifier la trémie et le disque. 2- Vérifier les seuils d'alarme. 3- Vérifier la cellule et les connexions. 4- Remplacer la cellule. 5- Remplacer l'ECU moteur.
321	Trop de graine - double.	1- Vérifier la trémie et le disque. 2- Vérifier les seuils d'alarme. 3- Vérifier la cellule et les connexions. 4- Remplacer la cellule. 5- Remplacer l'ECU moteur.
322	Vitesse de turbine trop faible.	1- Vérifier la vitesse de turbine. 2- Vérifier les seuils d'alarme. 3- Vérifier le capteur de turbine. 4- Remplacer la capteur de turbine.
323	Le TECU envoi une erreur de position d'attelage.	1- Vérifier le capteur de relevage du tracteur. Se référer à la notice tracteur. 2- Vérifier les réglages pour le capteur de relevage du tracteur. Se référer à la notice tracteur. 3- Vérifier la comptabilité ISOBUS.
324	Information position attelage TECU ou TECU non disponible.	1- Vérifier les réglages pour le capteur de relevage du tracteur. Se référer à la notice tracteur. 2- Aucun TECU disponible. Se référer à la notice tracteur.
325		
326	Semoir en position transport.	1- Baisser le semoir. 2- Vérifier les capteurs d'élément.
327	Semoir en position travail.	1- Lever le semoir. 2- Vérifier les capteurs d'élément.
328	Semoir en mode PAUSE.	1- Quitter le mode PAUSE.
329	Erreur de chargement de disque.	1- Vérifier les connexions du LIN sur l'ECU moteur. 2- Vérifier que le disque/moteur tourne librement.
331	Le semoir n'est pas arrêté (vitesse>0).	1- Arrêter d'avancer.
332	Autotest ECU moteur terminé.	1- Valider le message.
333	Distance entre graines invalide.	1- Changer la distance entre graines.
334	Trop peu d'entrée sur la CR8000.	1- La CR8000 ne correspond pas au nombre de rangs du semoir.
335	Pas de communication avec l'ECU moteur.	1- Vérifier la connexion LIN de l'ECU moteur Microsem. 2- Faire une mise à jour manuelle de l'ECU moteur si la LED de l'ECU moteur ne clignote pas régulièrement. 3- Remplacer l'ECU moteur Microsem.
336	Coupure d'alimentation sur la ligne moteur.	1- Vérifier les fils d'alimentation entre l'ECU moteur et le moteur Microsem. 2- Vérifier la connexion de l'alimentation de l'ECU moteur Microsem.
337	Surcharge moteur.	1- Vérifier que le moteur Microsem tourne librement. 2- Remplacer le moteur. 3- Remplacer l'ECU moteur Microsem.
338	Erreur de contrôle moteur ou défaut température.	1- Vérifier que le moteur Microsem tourne librement. 2- Remplacer l'ECU moteur Microsem.
339	Erreur logiciel sur ECU moteur.	1- Faire une mise à jour manuelle de l'ECU moteur Microsem. 2- Remplacer l'ECU moteur Microsem.
340	Défaut LIN bus.	1- Vérifier la connexion LIN de l'ECU moteur Microsem. 2- Remplacer le module ECV.
341	Défaut d'alimentation DUO power.	1- Vérifier la tension DUO power dans le module ECV. 2- Vérifier les fusibles.
342	Erreur logiciel sur module ECV.	1- Faire une mise à jour manuelle du module ECV. 2- Remplacer le module ECV.
343	Défaut d'alimentation DUO power.	1- Vérifier la tension DUO power dans le MM0X. 2- Vérifier les fusibles.
344	Surcharge moteur.	1- Vérifier que le moteur fertiliseur tourne librement. 2- Remplacer le moteur fertiliseur. 3- Remplacer le MM0X.
345	Erreur de contrôle moteur.	1- Vérifier que le moteur fertiliseur tourne librement. 2- Remplacer le MM0X.
346	Défaut de température sur le contrôle moteur.	1- Vérifier que le moteur fertiliseur tourne librement. 2- Remplacer le MM0X.
347	Erreur de tension sur MM0X.	1- Vérifier la tension d'alimentation du MM0X. 2- Vérifier les fusibles.
348	Erreur logiciel sur MM0X.	1- Faire une mise à jour manuelle du MM0X. 2- Remplacer le MM0X.

## LISTE DES ALARMES

Code alarme	Cause possible	Actions correctives
349	Connection impossible avec module ECV.	1- Vérifier les faisceaux du module ECV. 2- Vérifier la terminaison CAN sur le dernier ECV. 3- Vérifier les switches sur les modules ECV. 4- Vérifier que le nombre de modules ECV correspond à la configuration. 5- Faire une mise à jour manuelle du module ECV. 6- Remplacer le module ECV. 7- Remplacer l'ECU principal.
350	Connection impossible avec MM0X.	1- Vérifier les faisceaux du MM0X. 2- Vérifier que le MM0X connecté correspond à la configuration. 3- Faire une mise à jour manuelle du MM0X. 4- Remplacer le MM0X. 5- Remplacer l'ECU principal.
351	Calibration fertiliseur requise.	1- Faire une calibration fertiliseur.
352	Calibration Microsem requise.	1- Faire une calibration Microsem.
353	Changement de plage du fertiliseur dû à une nouvelle calibration.	1- Vérifier la dose cible.
354	Changement de plage Microsem dû à une nouvelle calibration.	1- Vérifier la dose cible.
355	Trémie fertiliseur vide.	1- Vérifier le niveau de la trémie. 2- Vérifier le capteur de niveau et les connections. 3- Remplacer la cellule. 4- Vérifier le code configuration. 5- Remplacer l'ECU principal.
356	Code configuration invalide.	1- Renseigner un code configuration valide.
357	Vitesse trop élevée : le moteur Microsem a atteint la limite haute de rotation.	1- Réduire la vitesse de travail. 2- Vérifier la constante de vitesse. 3- Vérifier sur 100m. 4- Contrôler le radar.
358	Tous les rangs sont désactivés.	1- Activer au moins 1 rang.
359	Blocage moteur Microsem.	1- Vérifier que le moteur Microsem tourne librement. 2- Vérifier la connexion du codeur entre le moteur et l'ECU moteur Microsem. 3- Remplacer l'ECU moteur Microsem.
360	Défaut d'alimentation codeur.	1- Vérifier les fils du codeur. 2- Remplacer l'ECU moteur Microsem. 3- Remplacer le moteur Microsem.
361	Pas de fileserver trouvé.	1- Vérifier que le Fileserver est présent et connecté à l'ISOBUS.
362	Défaut de connexion du boîtier raccordement radar/capteur de roue.	1- Vérifier la connexion du boîtier raccordement radar/capteur de roue. 2- Faire une mise à jour manuelle du boîtier raccordement radar/capteur de roue. 3- Remplacer le boîtier raccordement radar/capteur de roue.
363	Alimentation du boîtier raccordement radar/capteur de roue trop faible.	1- Vérifier l'alimentation du boîtier raccordement radar/capteur de roue. 2- Vérifier les fusibles. 3- Remplacer le boîtier raccordement radar/capteur de roue.
364	Pas de signal radar.	1- Vérifier la connexion du radar. 2- Vérifier la constante de vitesse. 3- Vérifier sur 100 m. 4- Vérifier le radar. 5- Remplacer le radar. 6- Remplacer le boîtier raccordement radar/capteur de roue.
365	Pas de signal du capteur de roue.	1- Vérifier la connexion du capteur de roue. 2- Vérifier la constante de vitesse 3- Vérifier sur 100 m.. 4- Vérifier le capteur de roue. 5- Remplacer le capteur de roue. 6- Remplacer le boîtier raccordement radar/capteur de roue.
366	TC-GEO est en mode automatique, mais le semoir est en mode espacement des grains.	1- Mettre le semoir en mode UNIFORME pour le réglage de la distance entre grains.
367	Le régime moteur dévie de plus de 10% de la valeur souhaitée.	1- Vérifier le bon fonctionnement du moteur d'engrais. 2- Remplacez le moteur d'engrais.



## ALARMS LISTING

- ①- Description of the alarm
- ②- Alarm number
- ③- Troubleshooting

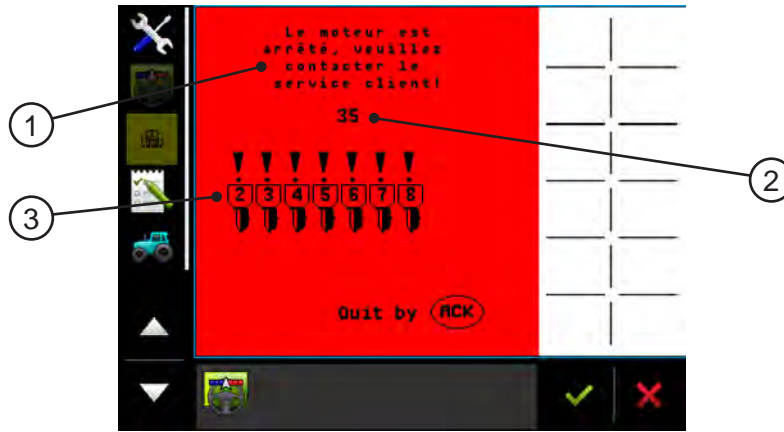

Alarm code	Cause	To do
31	ECU_PWR is lower than 10 V	1- Check ISOBUS power supply cables and fuses. Refer to tractor manual.
32	Regulated sensor power supply voltage is lower than 5 V	1- Check sensor cable for a short circuit. 2- Check for defective sensors.
33	Unregulated sensor power supply voltage is lower than 12 V	1- Check sensor cable for a short circuit. 2- Check for defective sensors.
34	Incorrect speed signal	1- Check connection of speed signal wire of the seed motor ECU.
35	No communication with motor ECU.	1- Check connection of the LIN signal wire of the seed motor ECU. 2- Do/Start a manual software update of the seed motor ECU if the green LED on the seed motor ECU is not flashing regularly. 3- Replace seed motor ECU.
36	No communication with LIN distributor.	1- Check connection cable between the 2 PCBs in the main ECU. 2- Do/Start a manual software update of the LIN distributor. 3- Replace main ECU.
37	Cable break on power lines of motor.	1- Check power connection between seed motor and seed motor ECU. 2- Check motor power connection of seed motor ECU. 3- Check fuses on LIN distributor.
38	ISO_PWR voltage is lower than 12 V	1- Check ISOBUS power supply cables and fuses. Refer to tractor manual.
39	Seeding disc/motor blocked	1- Check the ease of rotation of the seeding disc/motor. 2- Check encoder wires between seed motor and seed motor ECU. 3- Replace motor.
310	The speed is too high: Seed motor has reached the upper limit of turning.	1- Drive slower. 2- Check correct value for speed signal (Imp/100m). 3- Do a 100 m justification. 4- Check speed sensor.
311	Motor overload.	1- Check the ease of rotation of the seeding disc/motor. 2- Replace seed motor. 3- Replace seed motor ECU.
312	Motor control error or temperature fault.	1- Check the ease of rotation of the seeding disc/motor. 2- Replace seed motor ECU.
313	Software error on motor ECU.	1- Do/Start a manual software update of the seed motor ECU. 2- Replace seed motor ECU.
314	Encoder power supply fault.	1- Check encoder cable, possible short circuit. 2- Replace seed motor ECU. 3- Replace seed motor (encoder fault).
315	LIN bus fault.	1- Check connection of the LIN signal wire of the seed motor ECU, possible short circuit. 2- Replace main ECU.
316	DUO-Power supply fault.	1- Check the voltage of the DUO power in the main ECU. 2- Check all fuses.
317	Software error on LIN distributor.	1- Do/Start a manual software update of the LIN distributor. 2- Replace main ECU.
318	Rows disabled.	1- Information, that some rows are deactivated in the row configuration.
320	Hopper empty.	1- Check hopper level. 2- Check Grain sensor and connection. 3- Replace Grain sensor. 4- Replace seed motor ECU.



## ALARMS LISTING

Alarm code	Cause	To do
<b>320</b>	Too few grains.	1- Check hopper and seeding disc. 2- Check lower threshold setting for grains. 3- Check Grain sensor and connection. 4- Replace Grain sensor. 5- Replace seed motor ECU.
<b>321</b>	Too many grains.	1- Check hopper and seeding disc. 2- Check upper threshold setting for grains. 3- Check Grain sensor and connection. 4- Replace Grain sensor. 5- Replace seed motor ECU.
<b>322</b>	Fan speed too low.	1- Check fan speed. 2- Check setting for fan speed threshold. 3- Check fan speed sensor and connection. 4- Replace fan speed sensor.
<b>323</b>	TECU sends hitch position error.	1- Check hitch sensor on tractor. Refer tractor manual. 2- Check settings for hitch sensor in TECU. Refer to tractor manual. 3- Check ISOBUS compatibility of TECU.
<b>324</b>	TECU Hitch information or TECU not available.	1- Check settings for Hitch sensor in TECU. Refer to tractor manual. 2- No TECU on ISOBUS found. Refer to tractor manual.
<b>325</b>		
<b>326</b>	Machine in transport position.	1- Lower seeder. 2- Check working position sensor.
<b>327</b>	Machine in working position.	1- Lift up / Raise seeder. 2- Check working position sensor.
<b>328</b>	Machine in Pause mode.	1- Leave Pause mode.
<b>329</b>	Error during filling seed disc.	1- Check connection of the LIN signal wire of the motor ECU. 2- Check the ease of rotation of the seeding disc/motor.
<b>331</b>	Machine is not stopped (Speed > 0).	1- Stop driving.
<b>332</b>	Seeding Unit auto test finished.	1- Acknowledge the message.
<b>333</b>	Invalid grain distance.	1- Change grain distance or setpoint value.
<b>334</b>	Too few SBOX input.	1- Use a SBOX with more inputs.
<b>335</b>	No communication with motor ECU.	1- Check connection of the LIN signal wire of the MICROSEM motor ECU. 2- Do/start a manual software update of the motor ECU if the green LED on the motor ECU is not flashing regularly. 3- Replace MICROSEM motor ECU.
<b>336</b>	Cable break on power lines of motor.	1- Check power connection between MICROSEM motor and seed motor ECU. 2- Check motor power connection of MICROSEM motor ECU.
<b>337</b>	Motor overload.	1- Check the ease of rotation of the MICROSEM motor. 2- Replace MICROSEM motor. 3- Replace MICROSEM motor ECU.
<b>338</b>	Motor control error or temperature fault.	1- Check the ease of rotation of the MICROSEM motor. 2- Replace MICROSEM motor ECU.
<b>339</b>	Software error on motor ECU.	1- Do/Start a manual software update of the MICROSEM motor ECU. 2- Replace MICROSEM motor ECU.
<b>340</b>	LIN bus fault.	1- Check connection of the LIN signal wire of the MICROSEM motor ECU, possible short circuit. 2- Replace ECV.
<b>341</b>	DUO-Power supply fault.	1- Check the voltage of the DUO power in the ECV. 2- Check all fuses.
<b>342</b>	Software error on ECV.	1- Make a manual software update of the ECV. 2- Replace ECV.
<b>343</b>	DUO-Power supply fault.	1- Check the voltage of the DUO power in the MM0X. 2- Check all fuses.
<b>344</b>	Motor overload.	1- Check the ease of rotation of the fertilizer motor. 2- Replace fertilizer motor. 3- Replace MM0X.
<b>345</b>	Motor control error.	1- Check the ease of rotation of the fertilizer motor. 2- Replace MM0X.
<b>346</b>	Motor control temperature fault.	1- Check the ease of rotation of the fertilizer motor. 2- Replace MM0X.
<b>347</b>	Voltage of power supply of MM0X.	1- Check the voltage of the ECU power to the MM0X. 2- Check all fuses.
<b>348</b>	Software error on MM0X.	1- Do/Start a manual software update of the MM0X. 2- Replace MM0X.

## ALARMS LISTING

Alarm code	Cause	To do
<b>349</b>	Connection to ECV failed.	1- Check the connection cables of ECV. 2- Check the terminator connection on the last ECV. 3- Check the switches on the ECV. 4- Check that there are enough ECV connected to the corresponding machine configuration. 5- Do/Start a manual software update of the ECV. 6- Replace ECV. 7- Replace main ECU.
<b>350</b>	Connection to MMOX failed.	1- Check the connection cables of MMOX. 2- Check that there is the correct MMOX connected to the corresponding machine configuration. 3- Do/Start a manual software update of the MMOX. 4- Replace MMOX. 5- Replace main ECU.
<b>351</b>	Fertilizer adjustment required.	1- Do a fertilizer adjustment.
<b>352</b>	MICROSEM adjustment required.	1- Do a MICROSEM adjustment.
<b>353</b>	Target value of fertilizer changed due to new adjustment value	1- Check fertilizer target value.
<b>354</b>	Target value of MICROSEM changed due to new adjustment value.	1- Check MICROSEM target value.
<b>355</b>	Fertilizer hopper empty.	1- Check fertilizer hopper. 2- Check hopper level sensor connection. 3- Check hopper level sensor. 4- Check machine configuration. 5- Replace main ECU.
<b>356</b>	Machine code invalid.	1- Enter a correct machine code.
<b>357</b>	The speed is too high: MICROSEM motor has reached the upper limit of turning.	1- Drive slower. 2- Check correct value for speed signal (Imp/100m). 3- Do a 100 m justification. 4- Check speed sensor.
<b>358</b>	All rows are deactivated.	1- Activate at least one row.
<b>359</b>	MICROSEM motor blocked.	1- Check the ease of rotation of the MICROSEM motor. 2- Check encoder wires between seed motor and MICROSEM motor ECU. 3- Replace MICROSEM motor ECU.
<b>360</b>	Encoder power supply fault.	1- Check encoder cable, possible short circuit. 2- Replace MICROSEM motor ECU. 3- Replace MICROSEM motor (encoder fault).
<b>361</b>	No Fileserver found.	1- Check if there is a ISOBUS Fileserver connected to / present on the ISOBUS.
<b>362</b>	Connection to speed sensor switch failed.	1- Check connection to the speed sensor switch. 2- Do/Start a manual software update of the speed sensor switch. 3- Replace speed sensor switch.
<b>363</b>	Voltage on power supply for speed sensor switch to loo.	1- Check the voltage of the power of the speed sensor switch. 2- Check all fuses. 3- Replace speed sensor switch.
<b>364</b>	No signal from radar sensor.	1- Check the connection of the radar sensor. 2- Check correct value for speed signal of the radar sensor (Imp/100m). 3- Do a 100 m adjustment of the radar sensor. 4- Check radar sensor. 5- Replace radar sensor. 6- Replace speed sensor switch.
<b>365</b>	No signal from wheel sensor.	1- Check the connection of the wheel sensor. 2- Check correct value for speed signal of the wheel sensor (Imp/100m). 3- Do a 100 m adjustment of the wheel sensor. 4- Check wheel sensor. 5- Replace wheel sensor. 6- Replace speed sensor switch.
<b>366</b>	TC-GEO enabled, but the planter is set to seed spacing mode.	1- Set the planter to UNIFORM.
<b>367</b>	Motor rpm change more than 10% over the target.	1- Check the motor. 2- Replace the motor.



## LISTA DE ALARMAS

- ①- Descripción de la alarma
- ②- Número de alarma
- ③- Solución de problemas

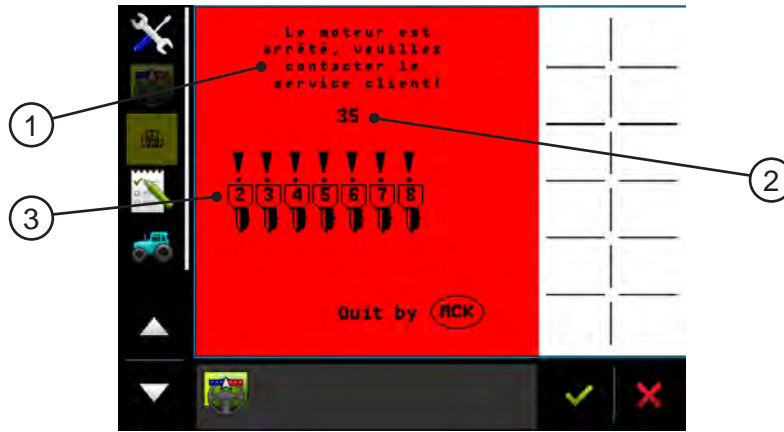

Cód. alarma	Posible causa	Acciones correctivas
31	Alimentación ECU < 10 V.	1- Comprobar los cables de alimentación ISOBUS y los fusibles. Consultar el manual del tractor.
32	Tensión de alimentación regulada de los captadores < 5 V.	1- Comprobar la continuidad de los cables del captador. 2- Comprobar los captadores.
33	Tensión de alimentación no regulada de los captadores < 12 V.	1- Comprobar la continuidad de los cables del captador. 2- Comprobar los captadores.
34	Señal de velocidad incorrecta.	1- Comprobar la conexión de la señal de velocidad en el ECU motor.
35	Sin comunicación con los ECU de los motores.	1- Comprobar la conexión LIN del ECU del motor. 2- Hacer una actualización manual del ECU del motor si el LED del ECU del motor no parpadea regularmente.
36	Sin comunicación con el distribuidor LIN.	1- Comprobar la conexión entre las 2 tarjetas PCB del ECU principal. 2- Hacer una actualización manual del distribuidor LIN. 3- Sustituir el ECU principal.
37	Corte de alimentación en la línea del motor.	1- Comprobar la conexión entre el motor y el ECU del motor. 2- Comprobar la alimentación del motor en el ECU del motor. 3- Comprobar los fusibles del distribuidor.
38	Alimentación ISOBUS < 12 V.	1- Comprobar los cables de alimentación ISOBUS y los fusibles. Consultar el manual del tractor.
39	Disco o motor bloqueado.	1- Comprobar que el disco/motor gira libremente. 2- Comprobar la conexión del codificador entre el motor y el ECU del motor. 3- Sustituir el motor.
310	Velocidad demasiado alta: el motor ha alcanzado el límite alto de revoluciones.	1- Reducir la velocidad de trabajo. 2- Comprobar la constante de velocidad. 3- Comprobar en 100 m. 4- Controlar el radar.
311	Sobrecarga del motor.	1- Comprobar que el disco/motor gira libremente. 2- Sustituir el motor. 3- Sustituir el ECU del motor.
312	Error de control del motor o fallo de temperatura.	1- Hacer una actualización manual del ECU del motor. 2- Sustituir el ECU del motor.
313	Error informático en el ECU del motor.	1- Hacer una actualización manual del ECU del motor. 2- Sustituir el ECU del motor.
314	Fallo de alimentación del codificador.	1- Comprobar la continuidad de los cables del codificador. 2- Sustituir el ECU del motor. 3- Sustituir el motor.
315	Fallo de bus LIN.	1- Comprobar la continuidad del cable LIN del ECU del motor. 2- Sustituir el ECU principal.
316	Fallo de alimentación DUO power.	1- Comprobar la tensión del ECU principal. 2- Revisar los fusibles.
317	Error informático en el distribuidor LIN.	1- Hacer una actualización manual del distribuidor LIN. 2- Sustituir el ECU principal.
318	Fila desactivada.	1- Informar que algunas filas están desactivadas.
319	Tolva vacía.	1- Comprobar el nivel de la tolva. 2- Comprobar la célula y las conexiones. 3- Sustituir la célula. 4- Sustituir el ECU del motor.

## LISTA DE ALARMAS

Cód. alarma	Posible causa	Acciones correctivas
320	Muy pocos granos – ausencia.	1- Comprobar la tolva y el disco. 2- Comprobar los umbrales de alarma. 3- Comprobar la célula y las conexiones. 4- Sustituir la célula. 5- Sustituir el ECU del motor.
321	Demasiados granos – doble.	1- Comprobar la tolva y el disco. 2- Comprobar los umbrales de alarma. 3- Comprobar la célula y las conexiones. 4- Sustituir la célula. 5- Sustituir el ECU del motor.
322	Velocidad de la turbina demasiado baja.	1- Comprobar la velocidad de la turbina. 2- Comprobar los umbrales de alarma. 3- Comprobar el captador de la turbina. 4- Sustituir el captador de la turbina.
323	El TECU envía un error de posición de enganche.	1- Revisar el captador de elevación del tractor. Consultar el manual del tractor. 2- Revisar los ajustes del captador de elevación del tractor. Consultar el manual del tractor. 3- Comprobar la contabilidad ISOBUS
324	Información de la posición de enganche TECU o TECU no disponible.	1- Comprobar los ajustes del captador de elevación del tractor. Consultar el manual del tractor. 2- Ningún TECU disponible. Consultar el manual del tractor.
325		
326	Sembradora en posición de transporte.	1- Bajar la sembradora. 2- Comprobar los captadores de elemento.
327	Sembradora en posición de trabajo.	1- Levantar la sembradora. 2- Comprobar los captadores de elemento.
328	Sembradora en modo PAUSA.	1- Salir del modo PAUSA.
329	Error de carga de disco.	1- Comprobar las conexiones del LIN en el ECU del motor. 2- Comprobar que el disco/motor gira libremente.
331	La sembradora está en marcha (velocidad>0).	1- Dejar de avanzar.
332	Autotest ECU motor terminado.	1- Validar el mensaje.
333	Distancia entre granos no válida.	1- Cambiar la distancia entre granos.
334	Muy poca entrada en la CR8000.	1- La CR8000 no se corresponde con el número de filas de la sembradora.
335	Sin comunicación con el ECU del motor.	1- Comprobar la conexión LIN del ECU del motor Microsem. 2- Hacer una actualización manual del ECU del motor si el LED del ECU del motor no parpadea regularmente. 3- Sustituir el ECU del motor Microsem.
336	Corte de alimentación en la línea del motor.	1- Comprobar los cables de alimentación entre el ECU del motor y el motor Microsem. 2- Comprobar la conexión de la alimentación del ECU del motor Microsem.
337	Sobrecarga en el motor.	1- Comprobar que el motor Microsem gira libremente. 2- Sustituir el motor. 3- Sustituir el ECU del motor Microsem.
338	Error de control del motor o fallo de temperatura.	1- Comprobar que el motor Microsem gira libremente. 2- Sustituir el ECU del motor Microsem.
339	Error informático en ECU del motor.	1- Hacer una actualización manual del ECU del motor Microsem. 2- Sustituir el ECU del motor Microsem.
340	Fallo en LIN bus.	1- Comprobar la conexión LIN del ECU del motor Microsem. 2- Sustituir el módulo ECV.
341	Fallo de alimentación DUO power.	1- Comprobar la tensión DUO power en el módulo ECV. 2- Comprobar los fusibles.
342	Error informático en módulo ECV.	1- Hacer una actualización manual del módulo ECV. 2- Sustituir el módulo ECV.
343	Fallo de alimentación DUO power.	1- Comprobar la tensión DUO power en el MM0X. 2- Revisar los fusibles.
344	Sobrecarga en el motor.	1- Comprobar que el motor del fertilizador gira libremente. 2- Sustituir el motor del fertilizador. 3- Sustituir el MM0X.
345	Error de control del motor.	1- Comprobar que el motor del fertilizador gira libremente. 2- Sustituir el MM0X.
346	Fallo de temperatura en el control del motor.	1- Comprobar que el motor del fertilizador gira libremente. 2- Sustituir el MM0X.
347	Error de tensión en MM0X.	1- Comprobar la tensión de alimentación del MM0X. 2- Revisar los fusibles.
348	Error informático en MM0X.	1- Hacer una actualización manual del MM0X. 2- Sustituir el MM0X.

## LISTA DE ALARMAS

Cód. alarma	Posible causa	Acciones correctivas
<b>349</b>	Conexión imposible con el módulo ECV.	1- Comprobar los cableados del módulo ECV. 2- Comprobar la terminación CAN en el último ECV. 3- Comprobar los switches en los módulos ECV. 4- Comprobar que el número de módulos ECV se corresponde con la configuración. 5- Hacer una actualización manual del módulo ECV. 6- Sustituir el módulo ECV. 7- Sustituir el ECU principal.
<b>350</b>	Conexión imposible con MMOX.	1- Comprobar los cableados del MMOX. 2- Comprobar que el MMOX conectado se corresponde con la configuración. 3- Hacer una actualización manual del MMOX. 4- Sustituir el MMOX. 5- Sustituir el ECU principal.
<b>351</b>	Calibración del fertilizador exigida.	1- Hacer una calibración del fertilizador.
<b>352</b>	Calibración de Microsem exigida.	1- Hacer una calibración de Microsem.
<b>353</b>	Cambio de margen del fertilizador debido a una nueva calibración.	1- Comprobar la dosis objetivo.
<b>354</b>	Cambio de margen Microsem debido a una nueva calibración.	1- Comprobar la dosis objetivo.
<b>355</b>	Tolva del fertilizador vacía.	1- Comprobar el nivel de la tolva. 2- Comprobar el captador de nivel y las conexiones. 3- Sustituir la célula. 4- Comprobar el código de configuración 5- Sustituir el ECU principal.
<b>356</b>	Código de configuración no válido.	1- Introducir un código de configuración válido.
<b>357</b>	Velocidad demasiado alta: el motor Microsem ha alcanzado el límite alto de giro.	1- Reducir la velocidad de trabajo. 2- Comprobar la constante de velocidad. 3- Comprobar en 100 m. 4- Controlar el radar.
<b>358</b>	Todas las filas están desactivadas.	1- Activar al menos 1 fila.
<b>359</b>	Bloqueo del motor Microsem.	1- Comprobar que el motor Microsem gira libremente. 2- Comprobar la conexión del codificador entre el motor y el ECU del motor Microsem. 3- Sustituir el ECU del motor Microsem.
<b>360</b>	Fallo de alimentación del codificador.	1- Revisar los cables del codificador. 2- Sustituir el ECU del motor Microsem. 3- Sustituir el motor Microsem.
<b>361</b>	No se ha encontrado Fileserver.	1- Comprobar que existe el Fileserver y que está conectado al ISOBUS.
<b>362</b>	Fallo de conexión de la caja de conexión radar/captador de rueda.	1- Comprobar la conexión de la caja de conexión radar/captador de rueda. 2- Hacer una actualización manual de la caja de conexión radar/captador de rueda. 3- Sustituir la caja de conexión radar/captador de rueda.
<b>363</b>	Alimentación de la caja de conexión radar/captador de rueda demasiado baja.	1- Comprobar la alimentación de la caja de conexión radar/captador de rueda. 2- Comprobar los fusibles. 3- Sustituir la caja de conexión radar/captador de rueda.
<b>364</b>	Sin señal de radar.	1- Comprobar la conexión del radar. 2- Comprobar la constante de velocidad. 3- Comprobar en 100 m. 4- Revisar el radar. 5- Sustituir el radar. 6- Sustituir la caja de conexión radar/captador de rueda.
<b>365</b>	Sin señal del captador de rueda.	1- Comprobar la conexión del captador de rueda. 2- Comprobar la constante de velocidad 3- Comprobar en 100 m. 4- Comprobar el captador de rueda. 5- Sustituir el captador de rueda. 6- Sustituir la caja de conexión radar/captador de rueda.
<b>366</b>	TC-GEO está en modo automático, pero la sembradora está en modo distancia entre granos.	1- Colocar la sembradora en modo UNIFORME para ajustar la distancia entre granos.
<b>367</b>	El régimen del motor se desvía más del 10 % del valor deseado.	1- Comprobar el buen funcionamiento del motor de fertilizante. 2- Sustituir el motor de fertilizante.





## ELENCO DEGLI ALLARMI

- ①- Descrizione dell'allarme  
 ②- Numero di allarme  
 ③- Risoluzione dei problemi

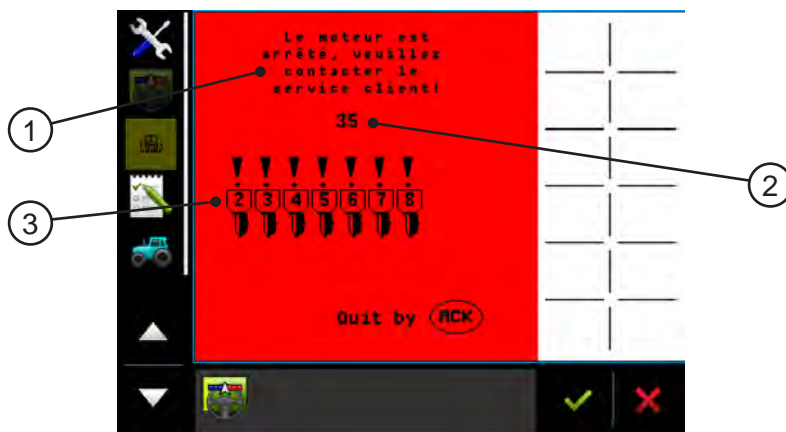

Codice allarme	Causa possibile	Azioni correttive
31	Alimentazione ECU < 10 V.	1- Controllare i fili di alimentazione ISOBUS e i fusibili. Vedere il libretto di istruzioni del trattore.
32	Tensione di alimentazione regolata dei sensori < 5 V.	1- Controllare la continuità dei fili di sensore. 2- Controllare i sensori.
33	Tensione di alimentazione non regolata dei sensori < 12 V.	1- Controllare la continuità dei fili di sensore. 2- Controllare i sensori.
34	Segnale di velocità errato.	1- Controllare il collegamento del segnale di velocità nell'ECU motore.
35	Nessuna comunicazione con le ECU motori.	1- Controllare il collegamento LIN dell'ECU motore. 2- Fare un aggiornamento manuale dell'ECU motore se il LED dell'ECU motore non lampeggia regolarmente.
36	Nessuna comunicazione con il distributore LIN.	1- Controllare il collegamento tra le 2 schede PCB dell'ECU principale. 2- Fare un aggiornamento manuale del distributore LIN. 3- Sostituire l'ECU principale.
37	Interruzione dell'alimentazione sulla linea del motore.	1- Controllare il collegamento tra il motore e l'ECU motore. 2- Controllare l'alimentazione del motore nell'ECU motore. 3- Controllare i fusibili sul distributore.
38	Alimentazione ISOBUS < 12 V.	1- Controllare i fili di alimentazione ISOBUS e i fusibili. Vedere il libretto di istruzioni del trattore.
39	Disco o motore bloccato.	1- Controllare che il disco/motore giri liberamente. 2- Controllare il collegamento dell'encoder tra il motore e l'ECU motore. 3- Sostituire il motore.
310	Velocità troppo elevata: il motore ha raggiunto il limite alto di rotazione.	1- Ridurre la velocità di lavoro. 2- Controllare la costante di velocità. 3- Controllare su 100m. 4- Controllare il radar.
311	Sovraccarico motore.	1- Controllare che il disco/motore giri liberamente. 2- Sostituire il motore. 3- Sostituire l'ECU motore.
312	Errore di controllo motore o difetto temperatura.	1- Controllare che il disco/motore giri liberamente. 2- Sostituire l'ECU motore.
313	Errore software sull'ECU motore.	1- Fare un aggiornamento manuale dell'ECU motore. 2- Sostituire l'ECU motore.
314	Errore di alimentazione encoder.	1- Controllare la continuità dei fili dell'encoder. 2- Sostituire l'ECU motore. 3- Sostituire il motore.
315	Errore bus LIN.	1- Controllare la continuità del filo LIN dell'ECU motore. 2- Sostituire l'ECU principale.
316	Errore di alimentazione DUO power.	1- Controllare la tensione dell'ECU principale. 2 - Controllare i fusibili.
317	Errore software su distributore LIN.	1- Fare un aggiornamento manuale del distributore LIN. 2- Sostituire l'ECU principale.
318	Fila disattivata.	1- Informa che alcune file sono disattivate.
319	Tramoggia vuota.	1- Controllare il livello della tramoggia. 2- Controllare la cellula e i collegamenti. 3- Sostituire la cellula. 4- Sostituire l'ECU motore.

## ELENCO DEGLI ALLARMI

Codice allarme	Causa possibile	Azioni correttive
320	Troppi pochi semi – mancanza.	1- Controllare la tramoggia e il disco. 2- Controllare le soglie di allarme. 3- Controllare la cellula e i collegamenti. 4- Sostituire la cellula. 5- Sostituire l'ECU motore.
321	Troppi semi – doppio.	1- Controllare la tramoggia e il disco. 2- Controllare le soglie di allarme. 3- Controllare la cellula e i collegamenti. 4- Sostituire la cellula. 5- Sostituire l'ECU motore.
322	Velocità di turbina troppo bassa.	1- Controllare la velocità di turbina. 2- Controllare le soglie di allarme. 3- Controllare il sensore di turbina. 4- Sostituire il sensore di turbina.
323	Il TECU invia un errore di posizione di aggancio.	1- Controllare il sensore di sollevamento del trattore. Vedere il libretto di istruzioni del trattore. 2- Controllare le regolazioni per il sensore di sollevamento del trattore. Vedere il libretto di istruzioni del trattore. 3- Controllare la compatibilità ISOBUS
324	Informazione posizione aggancio TECU o TECU non disponibile.	1- Controllare le regolazioni per il sensore di sollevamento del trattore. Vedere il libretto di istruzioni del trattore. 2- Nessun TECU disponibile. Vedere il libretto di istruzioni del trattore.
325		
326	Seminatrice in posizione di trasporto.	1- Abbassare la seminatrice. 2- Controllare i sensori di elemento.
327	Seminatrice in posizione di lavoro.	1- Sollevare la seminatrice. 2- Controllare i sensori di elemento.
328	Seminatrice in modo PAUSA.	1- Uscire dal modo PAUSA.
329	Errore di caricamento di disco.	1- Controllare le connessioni del LIN nell'ECU motore. 2- Controllare che il disco/motore giri liberamente.
331	La seminatrice non è ferma (velocità>0).	1- Fermare l'avanzamento.
332	Autotest ECU motore terminato.	1- Convalidare il messaggio.
333	Distanza tra semi non valida.	1- Cambiare la distanza tra semi.
334	Troppo poca entrata nella CR8000.	1- La CR8000 non corrisponde al numero di file della seminatrice.
335	Nessuna comunicazione con le ECU motore.	1- Controllare il collegamento LIN dell'ECU motore Microsem. 2- Fare un aggiornamento manuale dell'ECU motore se il LED dell'ECU motore non lampeggia regolarmente. 3- Sostituire l'ECU motore Microsem.
336	Interruzione dell'alimentazione sulla linea del motore.	1- Controllare i fili di alimentazione tra l'ECU motore e il motore Microsem. 2- Controllare il collegamento dell'alimentazione dell'ECU motore Microsem.
337	Sovraccarico motore.	1- Controllare che il motore Microsem giri liberamente. 2- Sostituire il motore. 3- Sostituire l'ECU motore Microsem.
338	Errore di controllo motore o difetto temperatura.	1- Controllare che il motore Microsem giri liberamente. 2- Sostituire l'ECU motore Microsem.
339	Errore software sull'ECU motore.	1- Fare un aggiornamento manuale dell'ECU motore Microsem. 2- Sostituire l'ECU motore Microsem.
340	Errore LIN bus.	1- Controllare il collegamento LIN dell'ECU motore Microsem. 2- Sostituire il modulo ECV.
341	Errore di alimentazione DUO power.	1- Controllare la tensione DUO power nel modulo ECV. 2- Controllare i fusibili.
342	Errore software sul modulo ECV.	1- Fare un aggiornamento manuale del modulo ECV. 2- Sostituire il modulo ECV.
343	Errore di alimentazione DUO power.	1- Controllare la tensione DUO power nell'MMOX. 2- Controllare i fusibili.
344	Sovraccarico motore.	1- Controllare che il motore del fertilizzatore giri liberamente. 2- Sostituire il motore del fertilizzatore. 3- Sostituire l'MMOX.
345	Errore controllo motore.	1- Controllare che il motore del fertilizzatore giri liberamente. 2- Sostituire l'MMOX.
346	Errore di temperatura sul controllo motore.	1- Controllare che il motore del fertilizzatore giri liberamente. 2- Sostituire l'MMOX.
347	Errore di tensione su MMOX.	1- Controllare la tensione di alimentazione dell'MMOX. 2- Controllare i fusibili.
348	Errore software su MMOX.	1- Fare un aggiornamento manuale dell'MMOX. 2- Sostituire l'MMOX.

## ELENCO DEGLI ALLARMI

Codice allarme	Causa possibile	Azioni correttive
<b>349</b>	Collegamento impossibile con il modulo ECV.	1- Controllare i fasci del modulo ECV. 2- Controllare la terminazione CAN sull'ultimo ECV. 3- Controllare gli switches sui moduli ECV. 4- Controllare che il numero di moduli ECV corrisponda alla configurazione. 5- Fare un aggiornamento manuale del modulo ECV. 6- Sostituire il modulo ECV. 7- Sostituire l'ECU principale.
<b>350</b>	Collegamento impossibile con MM0X.	1- Controllare i fasci dell'MM0X. 2- Controllare che l'MM0X collegato corrisponda alla configurazione. 3- Fare un aggiornamento manuale dell'MM0X. 4- Sostituire l'MM0X. 5- Sostituire l'ECU principale.
<b>351</b>	Calibrazione fertilizzatore richiesta.	1- Fare una calibrazione del fertilizzatore.
<b>352</b>	Calibrazione Microsem richiesta.	1- Fare una calibrazione Microsem.
<b>353</b>	Cambiamento di fascia del fertilizzatore dovuto a una nuova calibrazione.	1- Controllare la dose obiettivo.
<b>354</b>	Cambiamento di fascia Microsem dovuto a una nuova calibrazione.	1- Controllare la dose obiettivo.
<b>355</b>	Tramoggia fertilizzatore vuota.	1- Controllare il livello della tramoggia. 2- Controllare il sensore di livello e i collegamenti. 3- Sostituire la cellula. 4- Verificare il codice di configurazione 5- Sostituire l'ECU principale.
<b>356</b>	Codice di configurazione non valido.	1-Inserire un codice configurazione valido.
<b>357</b>	Velocità troppo elevata: il motore Microsem ha raggiunto il limite alto di rotazione.	1- Ridurre la velocità di lavoro. 2- Controllare la costante di velocità. 3- Controllare su 100 m. 4- Controllare il radar.
<b>358</b>	Tutte le file sono disattivate.	1- Attivare almeno 1 fila.
<b>359</b>	Bloccaggio motore Microsem.	1- Controllare che il motore Microsem giri liberamente. 2- Controllare il collegamento dell'encoder tra il motore e l'ECU motore Microsem. 3- Sostituire l'ECU motore Microsem.
<b>360</b>	Difetto di alimentazione encoder.	1- Controllare i fili dell'encoder. 2- Sostituire l'ECU motore Microsem. 3- Sostituire il motore Microsem.
<b>361</b>	Nessun Fileserver trovato.	1- Controllare che il Fileserver sia presente e collegato all'ISOBUS.
<b>362</b>	Errore di collegamento della scatola di raccordo radar/sensore di ruota.	1- Controllare il collegamento della scatola di raccordo radar/sensore di ruota. 2- Fare un aggiornamento manuale della scatola di raccordo radar/sensore di ruota. 3- Sostituire la scatola di raccordo radar/sensore di ruota.
<b>363</b>	Alimentazione della scatola di raccordo radar/sensore di ruota troppo debole.	1- Controllare l'alimentazione della scatola di raccordo radar/sensore di ruota. 2- Controllare i fusibili. 3- Sostituire la scatola di raccordo radar/sensore di ruota.
<b>364</b>	Nessun segnale radar.	1- Controllare il collegamento del radar. 2- Controllare la costante di velocità. 3- Controllare su 100 m. 4- Controllare il radar. 5- Sostituire il radar. 6- Sostituire la scatola di raccordo radar/sensore di ruota.
<b>365</b>	Nessun segnale del sensore di ruota.	1- Controllare il collegamento del sensore di ruota. 2- Controllare la costante di velocità 3- Controllare su 100 m. 4- Controllare il sensore di ruota. 5- Sostituire il sensore di ruota. 6- Sostituire la scatola di raccordo radar/sensore di ruota.
<b>366</b>	TC-GEO è in modo automatico, ma la seminatrice è in modo distanziamento dei semi.	1- Mettere la seminatrice in modo UNIFORME per la regolazione della distanza tra semi.
<b>367</b>	Il regime motore devia di più del 10% del valore desiderato.	1- Controllare il corretto funzionamento del motore del concime. 2- Sostituire il motore del concime.



## 9 - STOCKAGE DU MATÉRIEL

Avant l'hivernage du semoir, il est nécessaire de procéder à des travaux d'entretien et de nettoyage. Cette action est impérative pour que la machine reste toujours opérationnelle et performante mais aussi pour garantir à la machine une meilleure longévité.

### Travaux d'entretien avant hivernage :

Avant tout nettoyage, respectez impérativement les consignes de sécurité.

- Videz les trémies fertiliseur / Microsem / éléments
  - Ne laissez pas d'engrais dans la trémie fertiliseur et nettoyez obligatoirement les boîtiers de distribution.  
(Nettoyage à l'eau sans pression, vérifiez bien qu'il ne reste plus d'engrais, laissez sécher, cet appareil craint l'humidité)
  - Ne laissez pas de produits dans la trémie insecticide et nettoyez obligatoirement les boîtiers de distribution.  
(Nettoyage à l'eau sans pression, vérifiez bien qu'il ne reste pas de produit, laissez sécher, cet appareil craint l'humidité)
  - Ne laissez pas de graines dans la trémie d'élément, nettoyez les boîtiers à l'air comprimé.
  - Videz entièrement la vis de chargement.
- Passez une couche de graisse sur tous les outils ayant un contact avec le sol.
- Graissez les points d'articulation puis faites-les manœuvrer, ainsi que les tronçons télescopiques, la transmission, la prise de force et les pièces en mouvement.
- Un nettoyage des chaînes est indispensable. Si celles-ci sont encrassées, démontez-les puis trempez-les dans l'huile.
- Nettoyez l'intérieur des blocs roues en enlevant les carters de protection.
- Contrôlez le serrage des vis et écrous. Resserrez si nécessaire.
- Vérifiez l'état des pièces d'usure.
- En cas de casse de pièces, utilisez uniquement des pièces d'origine (Ribouleau MONOSEM).
- Pensez à commander vos pièces dès la fin de campagne, elles seront immédiatement disponibles en nos magasins.

**Le non-respect de ces consignes peut entraîner des usures prématurées ainsi qu'une gêne lors de la prochaine mise en route.**

## 9 - ALMACENAMIENTO DEL MATERIAL

Antes del invierno, es necesario realizar trabajos de mantenimiento y limpieza en la sembradora. Esta acción es imprescindible para que la máquina esté siempre operativa y eficiente pero también para garantizar a la máquina una mayor longevidad.

### Trabajos de mantenimiento antes del invierno:

Antes de limpiar la máquina, respetar siempre las medidas de seguridad.

- Vaciar las tolvas del fertilizador / Microsem / elementos
  - No dejar abono en la tolva del fertilizador y limpiar obligatoriamente las cajas de distribución.  
(Limpiar con agua sin presión, comprobar que no queda nada de abono, dejar secar, ya que este aparato no soporta la humedad)
  - No dejar productos en la tolva de insecticida y limpiar obligatoriamente las cajas de distribución.  
(Limpiar con agua sin presión, comprobar que no queda nada de abono, dejar secar, ya que este aparato no soporta la humedad)
  - No dejar granos en la tolva, limpiar las cajas con aire comprimido.
  - Vaciar totalmente el tornillo de carga.
- Aplicar una capa de grasa sobre todas las herramientas que tengan contacto con el suelo.
- Engrasar los puntos de articulación y hacerlos maniobrar, así como los elementos telescópicos, la transmisión, la toma de fuerza y las piezas en movimiento.
- Es indispensable limpiar las cadenas. Si están sucias, desmontarlas y sumergirlas en aceite.
- Limpiar el interior de los bloques de ruedas quitando los cárteres de protección.
- Controlar el apriete de tornillos y tuercas. Apretar si es necesario.
- Comprobar el estado de las piezas de desgaste.
- En caso de rotura de piezas, utilizar solamente piezas originales (Ribouleau MONOSEM).
- Tratar de pedir las piezas al final de la campaña, así estarán disponibles inmediatamente en nuestros almacenes.

**El incumplimiento de estas instrucciones puede provocar un desgaste prematuro y problemas en la próxima puesta en marcha.**

## 9 - STORING EQUIPMENT

Before storing the planter for the winter, it is necessary to carry out cleaning and maintenance. This is essential in order for the machine to remain operational at all times and perform correctly and also to ensure that the machine remains in service for many years to come.

### Maintenance work before winter storage:

Before cleaning, it is essential to read the safety instructions.

- Empty the units / microsem / fertilizer hoppers
  - Do not leave fertilizer in the hopper. It is essential that you clean the distribution units.  
(Clean with water – but not high-pressure jet – check that no fertilizer remains, leave to dry. This appliance must be kept dry)
  - Leave no products in the insecticide hopper. It is essential that you clean the distribution units.  
(Clean with water – but not high pressure jet – check that no product remains, leave to dry. This appliance must be kept dry)
  - Leave no seeds in the unit hopper; clean the distribution units with compressed air.
  - Completely empty the loading auger.
- Apply a layer of lubricant to all tools that come into contact with the ground.
- Lubricate the hinge points then move them, as well as the telescopic sections, transmission, power take-off and any moving parts.
- Cleaning the chains is essential. If they are clogged up, dismantle them then soak them in oil.
- Clean the inside of the wheel units (first remove the protective covers).
- Check tightness of screws and nuts. Tighten if necessary.
- Check the condition of wearing parts.
- If parts break, only replace with original manufacturer's parts (Ribouleau MONOSEM).
- Remember to order your parts as soon as the season ends; they will be immediately available in our stores.

**Failure to observe these instructions may result in premature wear as well as problems when the appliance is next switched on.**

## 9 - MAGAZZINAGGIO DEL MATERIALE

Prima di immagazzinare la seminatrice per l'inverno, occorre procedere a lavori di manutenzione e di pulizia. Queste operazioni sono necessarie per avere sempre la macchina perfettamente operativa e per consentire una maggiore durata della macchina stessa.

Lavori di manutenzione prima dell'inverno:

Prima di pulire, rispettare tassativamente le istruzioni di sicurezza.

- Svotare le tramogge fertilizzatore / Microsem / elementi
  - Non lasciare il concime nella tramoggia del fertilizzatore e pulire tassativamente le cassette di distribuzione.  
(Pulizia con acqua senza pressione, verificare che non resti più concime, lasciare asciugare, questo apparecchio risente dell'umidità)
  - Non lasciare prodotti nella tramoggia insetticida e pulire tassativamente le cassette di distribuzione.  
(Pulizia con acqua senza pressione, verificare che non resti più prodotto, lasciare asciugare, questo apparecchio risente dell'umidità)
  - Non lasciare i semi nella tramoggia di elemento, pulire le scatole con aria compressa.
- Svotare tutta la vite di caricamento.
- Passare uno strato di grasso su tutti gli strumenti in contatto con il suolo.
- Lubrificare i punti di articolazione, quindi farli manovrare, nonché i tronchi telescopici, la trasmissione, la presa di potenza e i pezzi in movimento.
- E' indispensabile pulire le catene. Se sono incrostate, smontarle quindi immergerle nell'olio.
- Pulire l'interno dei gruppi ruote rimuovendo i carter di protezione.
- Controllare il serraggio delle viti e dei dadi. Stringere ulteriormente se necessario.
- Verificare lo stato dei componenti usurabili.
- In caso di rottura dei pezzi, utilizzare soltanto ricambi originali (Ribouleau MONOSEM).
- Ricordarsi di ordinare i pezzi sin dalla fine della stagione, saranno immediatamente disponibili nei nostri magazzini.

Il mancato rispetto di queste istruzioni può comportare usura prematura nonché problemi durante la prossima messa in moto.

### Stockage de la machine :

Le respect des consignes suivantes est impératif :

- Toutes machines doivent être entreposées à l'abri de l'humidité sous un hangar.
- Déposez la machine sur une surface plane, solide et sûre.
- Remettez les béquilles de stationnement en position avant le dételage.
- L'opération de dételage doit s'effectuer lentement et avec prudence.
- Immobilisez le tracteur pour l'empêcher de bouger.
- Il est interdit de se trouver entre le tracteur et la machine lors des manœuvres.
- Les châssis repliables doivent être entreposés dépliés, les châssis télescopiques tronçons rentrés.
- Il est préférable de stocker les machines avec les vérins ayant la tige complètement rentrée. Si ce n'est pas possible, graissez les tiges de vérin.
- Retirez les connexions hydrauliques lorsque le circuit hydraulique n'est plus sous pression.
- Placez des cales sur la machine pour éviter qu'elle ne se déplace.
- Retirez et débranchez tout les appareils électroniques et stockez-les dans un endroit sec.

Le non-respect de ces consignes peut entraîner des blessures graves ou mortelles.

### Almacenamiento de la máquina:

Respetar siempre las siguientes instrucciones:

- Todas las máquinas deben almacenarse protegidas de la humedad en una nave.
- Dejar la máquina sobre una superficie plana, sólida y segura.
- Poner los cabalotes de estacionamiento en posición antes del desenganche.
- La operación de desenganche debe efectuarse lentamente y con prudencia.
- Inmovilizar el tractor para impedir que se mueva.
- Está prohibido situarse entre el tractor y la máquina durante las maniobras.
- Los chasis plegables deben almacenarse desplegados, y los chasis telescópicos con las secciones recogidas.
- Es preferible almacenar las máquinas con los cilindros con el vástago completamente recogido. Si no es posible, engrasar los vástagos.
- Retirar las conexiones hidráulicas cuando el circuito hidráulico deja de estar bajo presión.
- Colocar calces en la máquina para evitar que se desplace.
- Retirar y desconectar todos los aparatos electrónicos y almacenarlos en un lugar seco.

El incumplimiento de estas instrucciones puede provocar lesiones graves o mortales.

### Storing the machine:

It is essential that you observe the following instructions:

- All machines must be stored in a shed, to protect them from humidity.
- Place the machine on a flat, solid, secure surface.
- Put the parking stands in position before unhitching.
- Unhitching must be carried out carefully and slowly.
- Immobilise the tractor to prevent it from moving.
- It is forbidden to come between the tractor and the machine during manoeuvres.
- The folding frames must be stored unfolded, the telescopic sections of the frames retracted.
- It is preferable to store the machines with the cylinder rods completely retracted. If this is not possible, lubricate the cylinder rods.
- Remove the hydraulic connections when the hydraulic circuit is no longer under pressure.
- Place wedges on the machine to prevent it from moving.
- Remove and disconnect all the electronic instruments and store them in a dry place.

Failure to observe these instructions may result in serious or fatal injuries.

### Magazzinaggio della macchina:

E' tassativo rispettare le seguenti istruzioni:

- Tutte le macchine devono essere depositate al riparo dell'umidità, in un capannone.
- Collocare la macchina su di una superficie piana, solida e sicura.
- Rimettere i sostegni di stazionamento in posizione prima dello sganciamento.
- L'operazione dello sganciamento si deve effettuare lentamente e con prudenza.
- Immobilizzare il trattore per impedirgli di muoversi.
- E' vietato trovarsi tra il trattore e la macchina durante le manovre.
- I telai pieghevoli devono essere immagazzinati aperti, i telai telescopic con i tronchi rientrati.
- E' preferibile immagazzinare le macchine con i martinetti aventi l'asta completamente rientrata. Se non fosse possibile, lubrificare le aste dei martinetti.
- Rimuovere i collegamenti idraulici quando il circuito idraulico non è più sotto pressione.
- Mettere delle zeppe sulla macchina per evitare che si sposti.
- Rimuovere e scollegare tutti gli apparecchi elettronici e conservarli in un luogo asciutto.

Il mancato rispetto di queste istruzioni può comportare infortuni gravi se non mortali.

# NOTES

.....

.....

.....

.....

.....

.....

.....

.....

.....

.....

.....

.....

.....

.....

.....

.....

.....

.....

.....

.....

.....



Par soucis d'amélioration continue de notre production, nous nous réservons le droit de modifier sans préavis nos matériels qui, de ce fait, pourront par certains détails être différents de ceux décrits sur cette notice.



Photographies non contractuelles.



**MONOSEM**

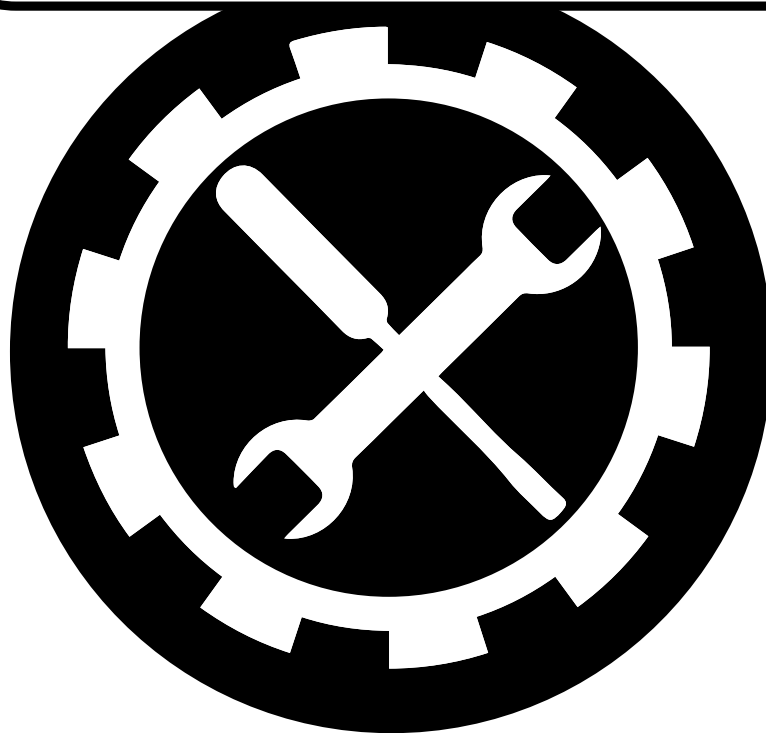

PIÈCES DE RECHANGE  
SPARE PARTS  
PIEZAS DE REPUESTO  
PEZZI DI RICAMBIO

## DISTRIBUTION & ENTRAINEMENT NG Plus Me (1) sup2018

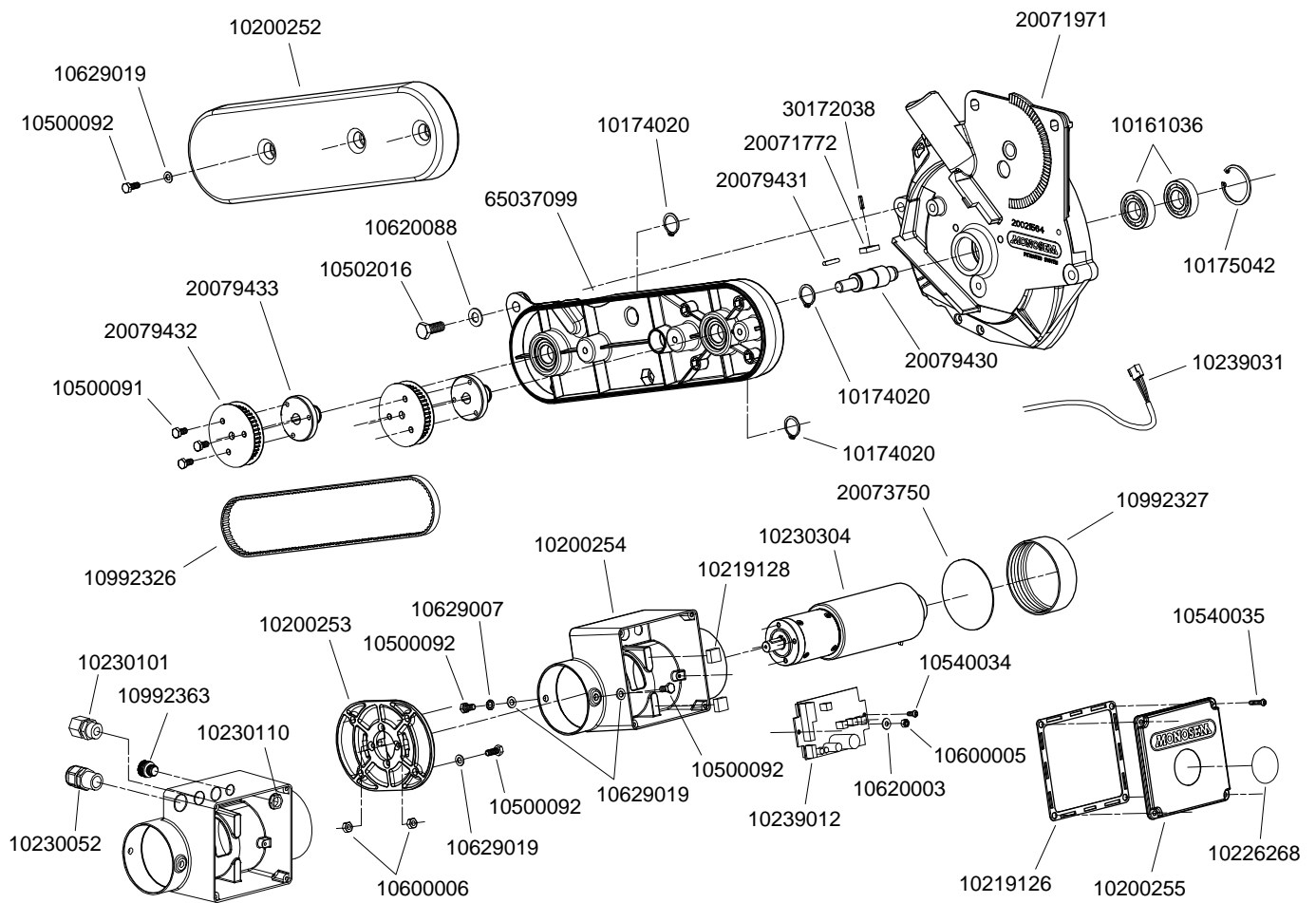

P06160180

Réf. OLD	Réf. NEW	Désignation	Réf. OLD	Réf. NEW	Désignation
	10161036	Roulement 6004.2RK		20073750	Disque de protection moteur
6213	10174020	Anneau élastique ext. Ø30		20079430	Axe de boîtier NG Plus Me
	10175042	Anneau élastique int. Ø42		20079431	Clavette bout d'axe de boîtier NG Plus Me
	10200252	Couvercle de transmission NG Plus Me		20079432	Poulie Z40
	10200253	Support moteur NG Plus Me		20079433	Moyeu de poulie
	10200254	Tube fourreau support carte électronique		30172038	Goupille élastique Ø4 x 14 inox
	10200255	Couvercle plastique pour tube fourreau		65037099	Support transmission NG Plus Me
	10219126	Joint de couvercle			
	10219128	Tampon pour carte électronique			
	10226268	Autocollant «nettoyage haute pression interdit)»			
	10230052	Presse étoupe PG11 court			
	10230101	Presse étoupe PG9			
	10230110	Écrou autobloquant M12			
	10230304	Moteur pour entraînement NG Plus Me			
	10239012	Carte électronique ECU moteur			
	10239031	Faisceau codeur pour moteur			
	10500091	Vis H M6 x 12			
	10500092	Vis H M6 x 16			
	10502016	Vis H M10 x 25			
	10540034	Vis TC M4 x 20 inox			
	10540035	Vis tête bombée 4 x 20			
	10600005	Écrou H M5			
	10600006	Écrou H M6			
	10620003	Rondelle Ø5 x 12 x 0,8			
	10620088	Rondelle Ø10,5 x 20 x 1,5			
	10629007	Rondelle AZ Ø6 inox			
	10629019	Rondelle Ø6,4 x 12 x 1,2 inox			
	10992326	Courroie pour transmission NG Plus Me			
	10992327	Bouchon à anneaux			
	10992363	Pressure compensation			
	20071772	Clavette inox de boîtier			
	20071971	Corps de boîtier NG Plus Me			

## DISTRIBUTION & ENTRAINEMENT NG Plus M<sub>E</sub> (2)

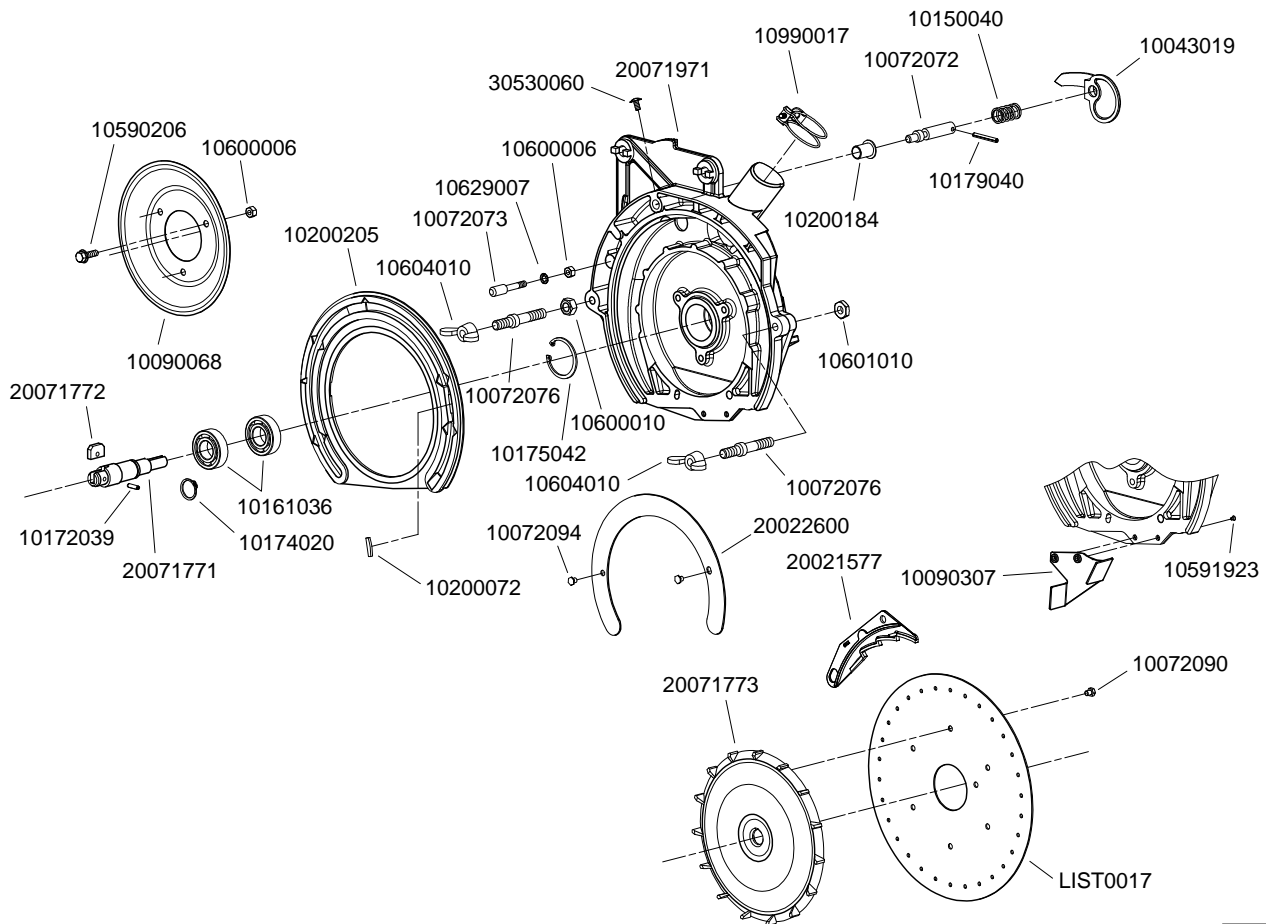

P06160020

Réf. OLD	Réf. NEW	Désignation	Réf. OLD	Réf. NEW	Désignation
6217	10072072	Axe mobile de sélecteur			
6216	10072073	Axe fixe de sélecteur			
6208	10072076	Axe latéral de blocage couvercle			
6222	10072090	Vis de blocage M5 x 6			
6223	10072094	Vis de fixation couronne d'appui			
6206	10090068	Calotte de serrage			
1241	10090307	Tôle cache goulotte			
6227	10150040	Ressort d'index			
	10161036	Roulement 6004.2RS			
	10172038	Goupille élastique Ø4 x 14			
6213	10174020	Anneau élastique ext. Ø20			
	10175042	Anneau élastique int. Ø42			
	10179040	Goupille spirale Ø4 x 35			
6230.a	10200072	Bouchon amovible pour roue à ailettes 6073.1a			
	10200184	Bague plastique			
	10200209	Insert plastique de frottement			
	10507012	Vis H M10 x 16			
	10590206	Vis H M6 x 20 à embase			
	10600006	Écrou H M6			
	10601010	Écrou Hm M10			
5692	10604010	Écrou papillon M10			
	10629007	Rondelle AZ Ø8			
4453	10990017	Collier de serrage Ø40			
6211	20021577	Plaque de sélection standard			
6209.a	20022600	Couronne d'appui pour insert plastique			
	20071771	Axe central de boîtier NG Plus Me			
	20071772	Clavette inox pour axe de boîtier NG Plus Me			
	20071773	Agitateur boîtier NG Plus Me			
	20071971	Boîtier NG Plus 4 & M – entraînement électrique			
	30530060	Vis Poëlier M5 x 10			
	LIST0017	Divers disques NG Plus			

# DISTRIBUTION & ENTRAÎNEMENT MECA V4E (1) sup2018

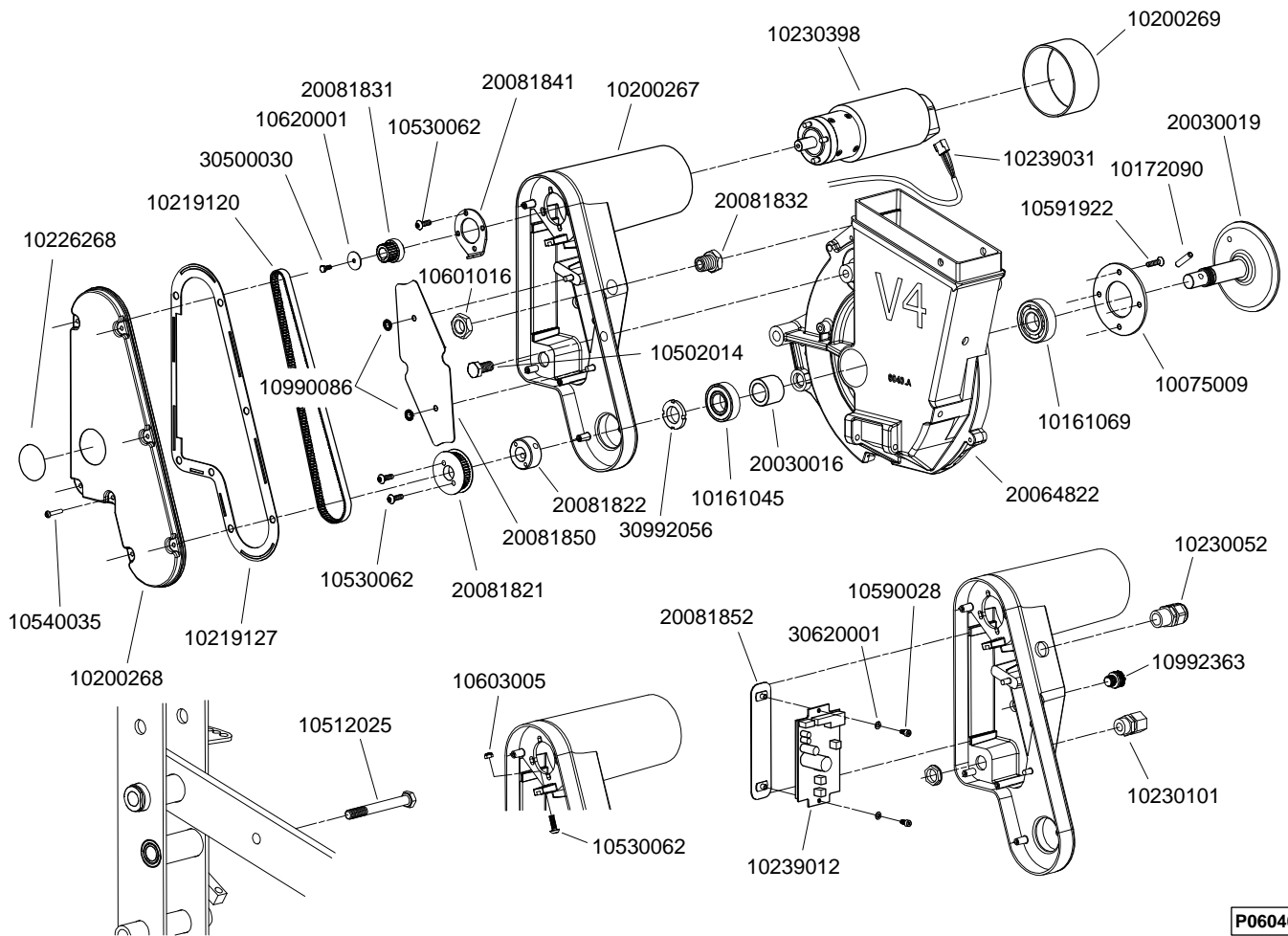

P06040180

Réf. OLD	Réf. NEW	Désignation	Réf. OLD	Réf. NEW	Désignation
	10075009	Rondelle de serrage		20081832	Écrou de fixation
6221	10161045	Roulement 6004.2HRS		20081841	Platine tendeur de courroie
11513	10161069	Roulement 6204.2RK		20081850	Tôle protection courroie
	10172090	Goupille élastique Ø6 x 26		20081852	Tôle support carte électronique
	10200267	Support transmission MECA V4e		30500030	Vis H M4 x 10 inox
	10200268	Couvercle de transmission MECA V4e		30620001	Rondelle Ø4,3 x 8 x 0,8 inox
	10200269	Embout plastique de boîtier		30992056	Écrou de serrage KM4
	10219120	Courroie pour transmission MECA V4e			
	10219127	Joint de couvercle			
	10226268	Autocollant «nettoyage haute pression interdit»			
	10230052	Presse étoupe PG11 court			
	10230101	Presse étoupe PG9			
	10230398	Moteur pour entraînement MECA V4e			
	10239012	Carte électronique ECU moteur			
	10239031	Faisceau codeur pour moteur			
	10502014	Vis H M10 x 20			
	10512025	Vis H M10 x 80			
	10530062	Vis TBHC M5 x 16 inox			
	10540035	Vis tête bombée 4 x 20			
	10590028	Vis CHC M4 x 8 inox			
	10591922	Vis TFHC M5 x 20 inox			
	10601016	Écrou Hm M16			
	10603005	Écrou frein M5 inox			
	10620001	Rondelle Ø4,3 x 20 x 1,25			
6090	10990086	Anneau d'arrêt SLR Ø6			
	10992363	Pressure compensation			
	20030016	Entretoise de roulement (40090273)			
6044	20030019	Axe de boîtier MECA V4			
6040.a	20064822	Corps de boîtier MECA V4			
	20081821	Poulie Z44			
	20081822	Support poulie			
	20081831	Poulie Z22			

# BOITIER MECA V4

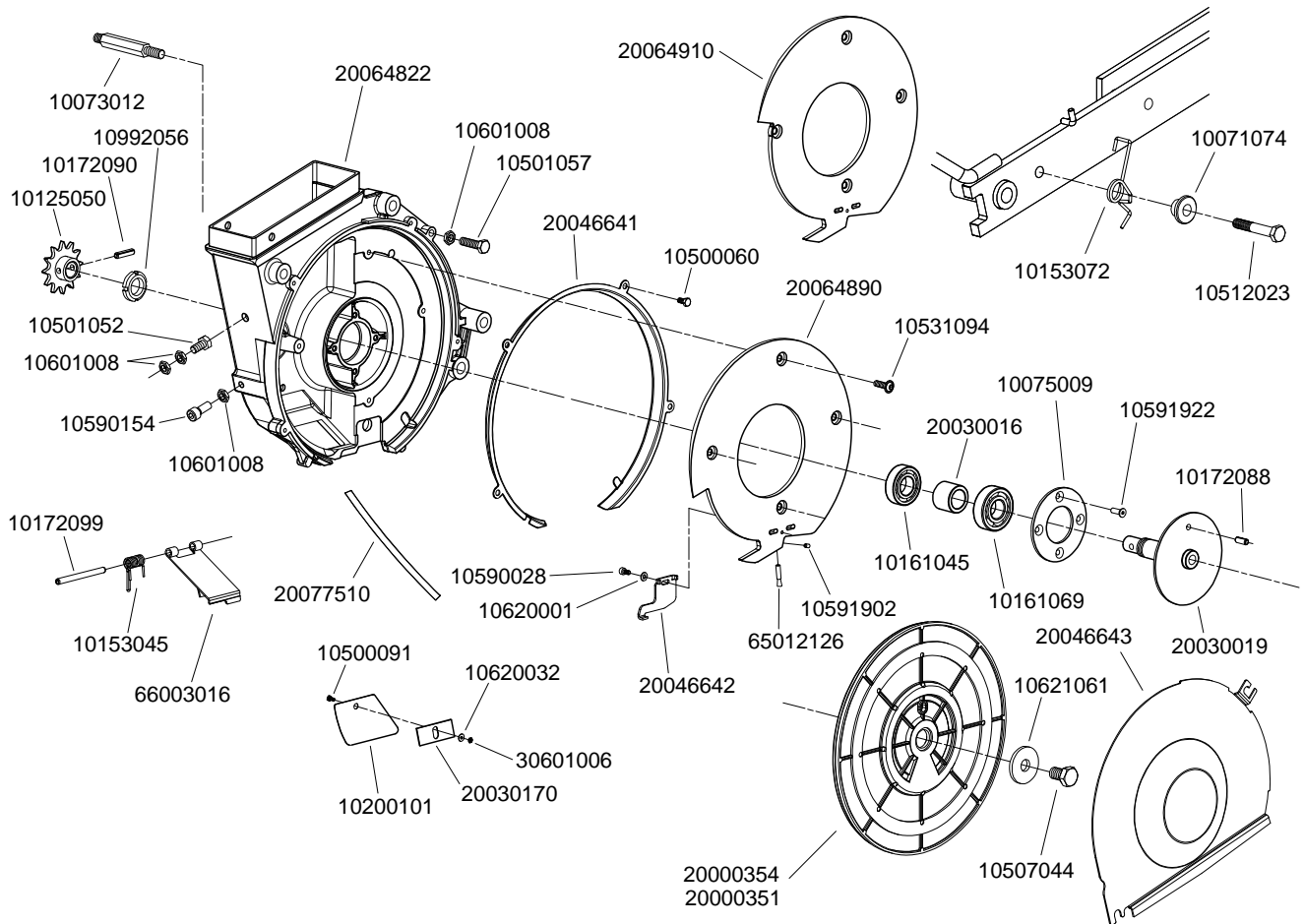

P06040011

Réf. OLD	Réf. NEW	Désignation	Réf. OLD	Réf. NEW	Désignation
1339	10071074	Bague d'articulation	6256	20030170	Plaque serrage film
6265	10073012	Entretoise de carter	6047	20046641	Insert inox boîtier MECA
6045	10075009	Rondelle de serrage	6048	20046642	Ejecteur boîtier MECA (40090271)
6259	10125050	Pignon 12 dents	6041	20046643	Tôle protège disque
6081.a	10153045	Ressort (R 133)	6040.a	20064822	Boîtier MECA V4 >2011 (6040.a)
6311	10153072	Ressort de maintien		20064890	Plaque sélection Betterave (Boîtier MECA V4 >2011)
6221	10161045	Roulement 6004,2RS (SKF)		20064910	Plaque sélection Endive / Chicorée (Boîtier >2011)
11513	10161069	Roulement 6204,2RS		20077510	Clinquant de calage
	10172088	Goupille élastique Ø6 x 15		30601006	Écrou Hm M6
	10172090	Goupille élastique Ø6 x 25	5064.b	65012126	Brosse de boîtier (65012126)
	10172099	Goupille élastique Ø6 x 70	6264	66003016	Trappe de vidange
6257	10200101	Film plastique			
	10500060	Vis H M5 x 10			
	10500091	Vis H M6 x 12			
	10501052	Vis H M8 x 16			
	10501057	Vis H M8 x 30			
	10507044	Vis H M12 x 20			
	10512023	Vis H M10 x 60			
	10531094	Vis six pans M6 x 20 « tête bombée »			
	10590028	Vis CHC M4 x 8			
	10590154	Vis CHC M8 x 20			
	10591902	Vis sans tête HC M4 x 6			
	10591922	Vis TFHC M5 x 20			
	10601008	Écrou Hm M8			
	10620001	Rondelle Ø4,3 x 8 x 0,8			
	10620032	Rondelle Ø6,5 x 15 x 1			
	10621061	Rondelle Ø13 x 40 x 4			
	10992056	Écrou serrage KM4			
6043	20000351	Disque 5,5 E5			
6042	20000354	Disque 5,7 E5			
4472	20030016	Entretoise de roulements (40090273)			
6044	20030019	Axe du boîtier			

# ENTRAINEMENT MICROSEM ÉLECTRIQUE

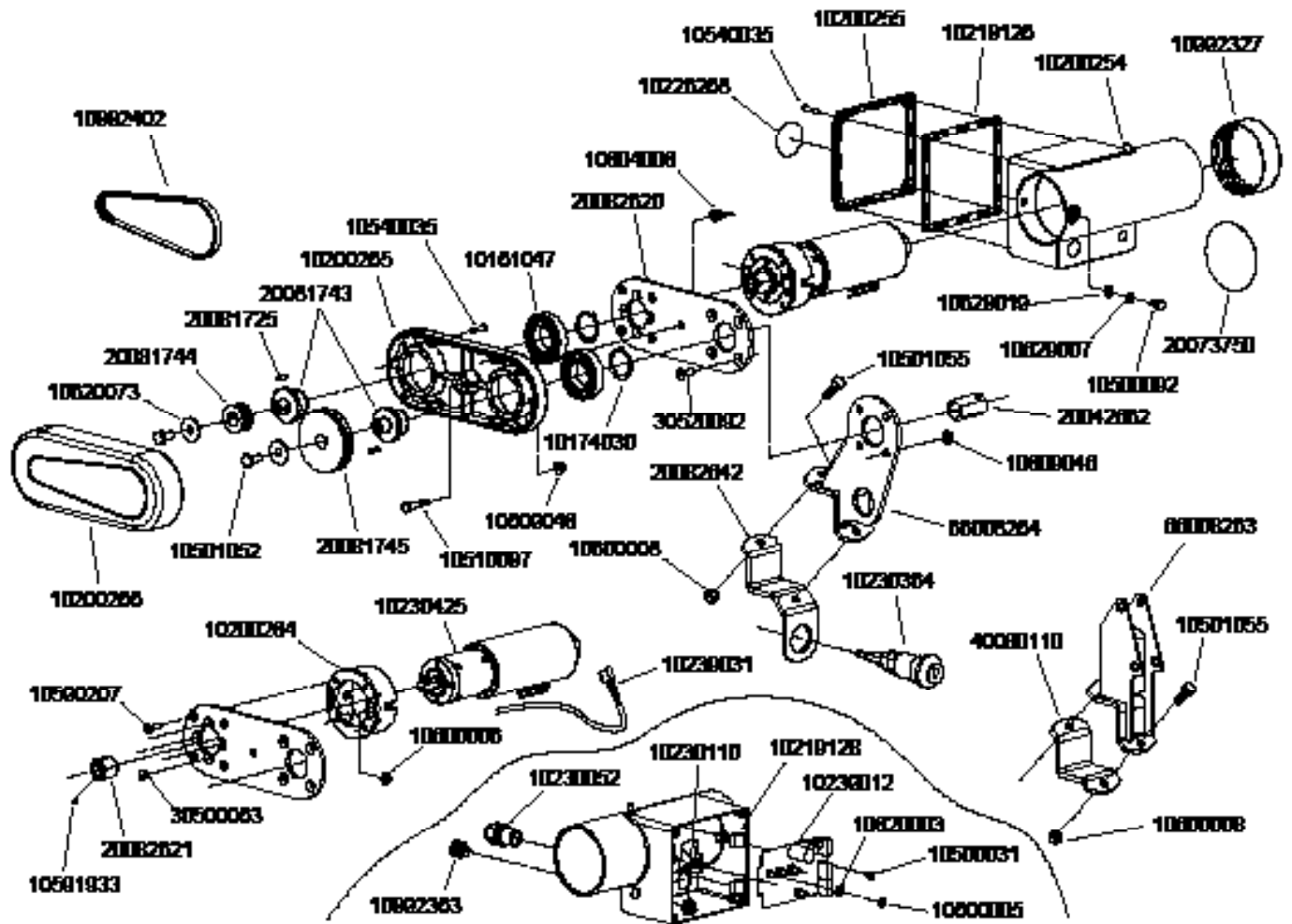

PR15M284

Réf. OLD	Réf. NEW	Désignation	Réf. OLD	Réf. NEW	Désignation
11579	10161047	Roulement 6006.DDI		10629019	Rondelle Ø6,4 x 12 x 1,2 inox
6915	10174030	Anneau élastique ext. Ø30		10992327	Bouchon à anneaux
	10200254	Tube fourreau support carte électrique		10992363	Pressure compensation
	10200255	Couvercle plastique pour tube fourreau		10992402	Courroie pour transmission Microsem électrique
	10200264	Embase tube moteur		20042662	Axe hexagonal femelle
	10200265	Boîtier de transmission Microsem électrique		20073750	Disque de protection moteur
	10200266	Couvercle de transmission Microsem électrique		20081725	Clavette d'accouplement 4 x 4 x 14
	10219126	Joint de couvercle		20081743	Moyeu de poulie
	10219128	Tampon pour carte électronique		20081744	Poulie Z18
	10226268	Autocollant «nettoyage haute pression interdit»		20081745	Poulie Z40
	10230052	Presse étoupe PG11 court		20082620	Tôle support transmission électrique
	10230110	Écrou autobloquant M12		20082621	Adaptateur en bout d'axe moteur
	10230364	Bouton étalonnage		20082642	Contre bride support bouton
	10230425	Moteur pour entraînement Microsem		30500063	Vis TF M5 x 10 inox
	10239012	Carte électronique ECU moteur		30520092	Vis TF M6 x 16
	10239031	Faisceau codeur pour moteur	9472	40080110	Contre bride barre carré de 40
	10500031	Vis tête cylindrique bombé 4 x 10 pour plastique		66008263	Chape de fixation Microsem électrique
	10500092	Vis H M6 x 16		66008264	Support transmission Microsem électrique
	10501052	Vis H M8 x 16			
	10501055	Vis H M8 x 25			
	10510097	Vis H M6 x 30			
	10540035	Vis tête bombée 4 x 20			
	10590207	Vis TF M5 x 20			
	10591933	Vis STHC M4 x 5			
	10600005	Écrou H M5			
	10600006	Écrou H M6			
	10600008	Écrou H M8			
6461	10604006	Écrou à oreilles M6			
	10609046	Écrou à embase cranté M6 inox			
	10620003	Rondelle Ø5 x 12 x 0,8			
	10620073	Rondelle Ø8,5 x 27 x 2			
	10629007	Rondelle AZ Ø6 inox			



# MONTAGE ALTERNATEUR TURBINE ÉLECTRIQUE MD & GD sup2017

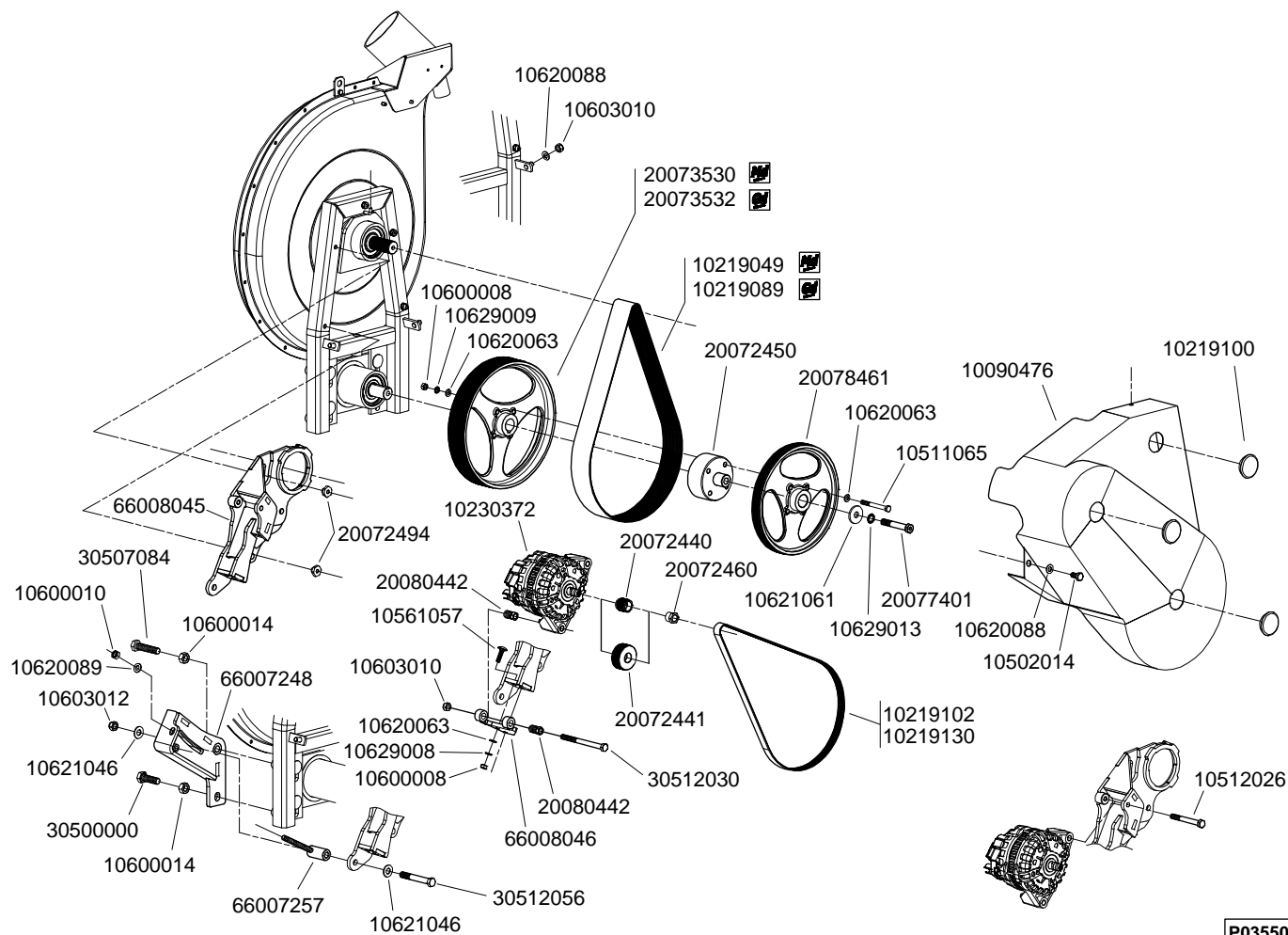

P03550060

Réf. OLD	Réf. NEW	Désignation	Réf. OLD	Réf. NEW	Désignation
	10090476	Cartier de courroie (turbine MD et GD)		20078461	Poulie réceptrice 8 gorges
4413.a	10219049	Courroie 20 gorges large		20080442	Vis de réglage position alternateur
4413.b	10219089	Courroie 25 gorges(trubine GD)		30500000	Vis H M14 x 45
	10219100	Bouchon pour carter		30507084	Vis H M14 x 65
	10219102	Courroie pour poulie Ø28	5687	30512030	Vis H M10 x 130
	10219130	Courroie pour poulie Ø56		30512056	Vis H M12 x 90
	10230372	Alternateur avec excitation (BOSCH)		66007248	Support fixation alternateur (turbine MD et GD)
	10502014	Vis H M10 x 20		66007257	Tendeur entrainement alternateur (turbine MD et GD)
	10511065	Vis H M8 x 80		66008045	Support mobile d'alternateur (turbine MD et GD)
	10512026	Vis H M10 x 90		66008046	Support douille de réglage
	10561057	Vis TRCC M8 x 30			
	10600008	Écrou H M8			
	10600010	Écrou H M10			
	10600014	Écrou H M14			
	10603010	Écrou frein H M10			
	10603012	Écrou frein H M12			
	10620063	Rondelle Ø8,5 x 16 x 1,5			
	10620088	Rondelle Ø10,5 x 20 x 1,5			
	10620089	Rondelle Ø10,5 x 20 x 2			
	10621046	Rondelle Ø13 x 27 x 2			
	10621061	Rondelle Ø13 x 40 x 4			
	10629008	Rondelle AZ Ø8 inox			
	10629009	Rondelle AZ Ø8			
	10629013	Rondelle AZ Ø13			
	20072440	Poulie motrice 8 gorges Ø28			
	20072441	Poulie motrice 8 gorges Ø56			
	20072450	Entretoise de poulie réceptrice			
	20072460	Écrou de serrage poulie motrice (alternateur)			
	20072494	Écrou de serrage support mobile d'alternateur			
	20073530	Poulie 20 groges (540 tr/min)			
	20073532	Poulie 25 groges (540 tr/min)			
	20077401	Vis H M12 x 80 avec point de centre			



# MONTAGE ALTERNATEUR TURBINE ÉLECTRIQUE DF sup2017

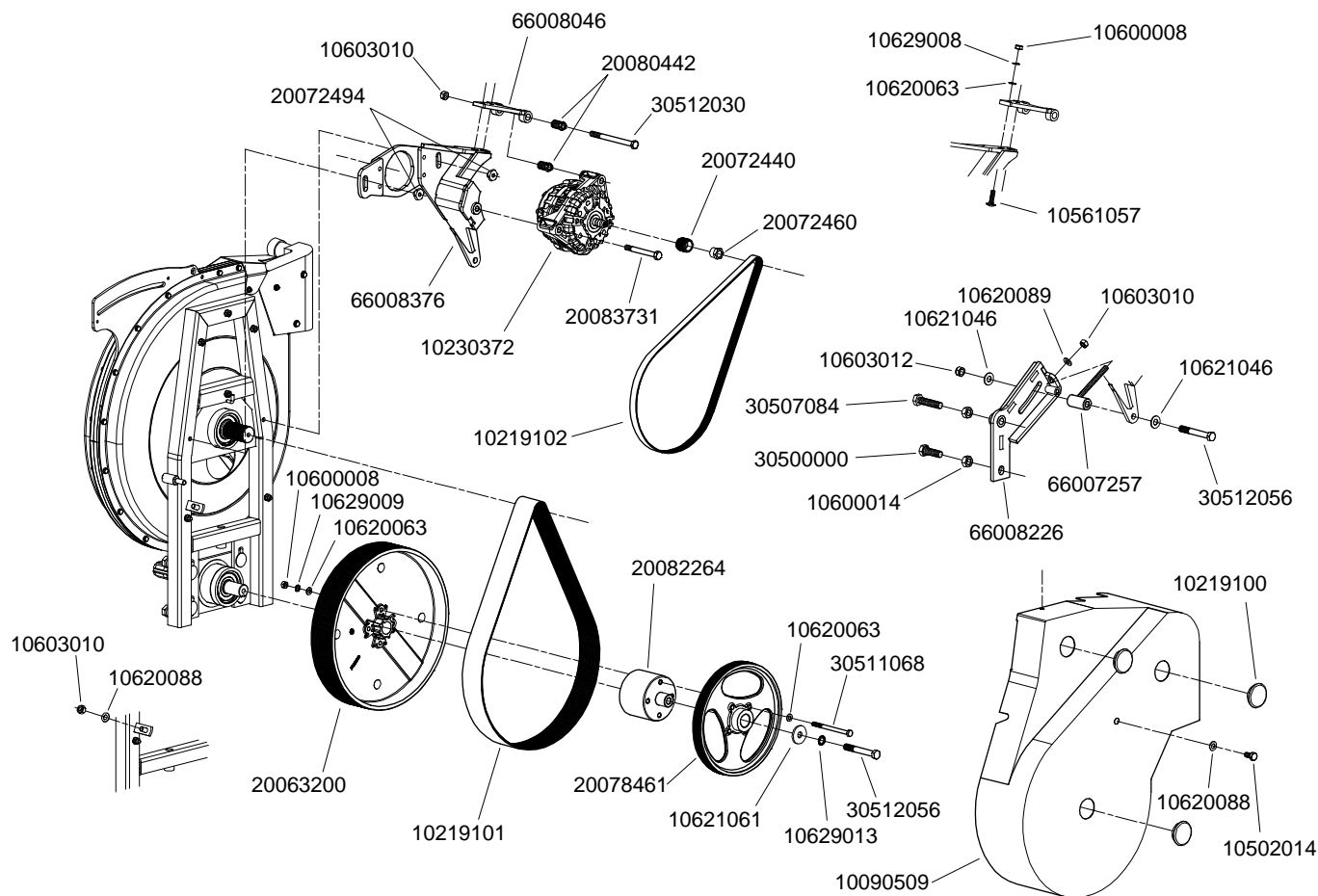

P03550080

Réf. OLD	Réf. NEW	Désignation	Réf. OLD	Réf. NEW	Désignation
	10090509	Carter de courroie (turbine DF)		66007257	Tendeur entrainement alternateur (turbine MD et GD)
	10219100	Bouchon pour carter		66008046	Support douille de réglage
	10219101	Courroie pour poulie Ø360		66008226	Support fixation alternateur (turbine DF)
	10219102	Courroie pour poulie Ø28		66008376	Support mobile d'alternateur (turbine DF)
	10230372	Alternateur avec excitation (BOSCH)			
	10502014	Vis H M10 x 20			
	10561057	Vis TRCC M8 x 30			
	10600008	Écrou H M8			
	10600014	Écrou H M14			
	10603010	Écrou frein H M10			
	10603012	Écrou frein H M12			
	10620063	Rondelle Ø8,5 x 16 x 1,5			
	10620088	Rondelle Ø10,5 x 20 x 1,5			
	10620089	Rondelle Ø10,5 x 20 x 2			
	10621046	Rondelle Ø13 x 27 x 2			
	10621061	Rondelle Ø13 x 40 x 4			
	10629008	Rondelle AZ Ø8 inox			
	10629009	Rondelle AZ Ø8			
	10629013	Rondelle AZ Ø13			
	20063200	Poulie 25 groges (turbine DF)			
	20072440	Poulie motrice 8 gorges Ø28			
	20072460	Écrou de serrage poulie motrice (alternateur)			
	20072494	Écrou de serrage support mobile d'alternateur			
	20078461	Poulie réceptrice 8 gorges			
	20080442	Vis de réglage position alternateur			
	20082264	Entretoise de poulie réceptrice (turbine DF)			
	20083731	Axe de support mobile			
	30500000	Vis H M14 x 45			
	30507084	Vis H M14 x 65			
	30511068	Vis H M8 x 110			
5687	30512030	Vis H M10 x 130			
	30512056	Vis H M12 x 90			

# MONTAGE ALTERNATEUR TURBINE ÉLECTRIQUE TGD sup2018

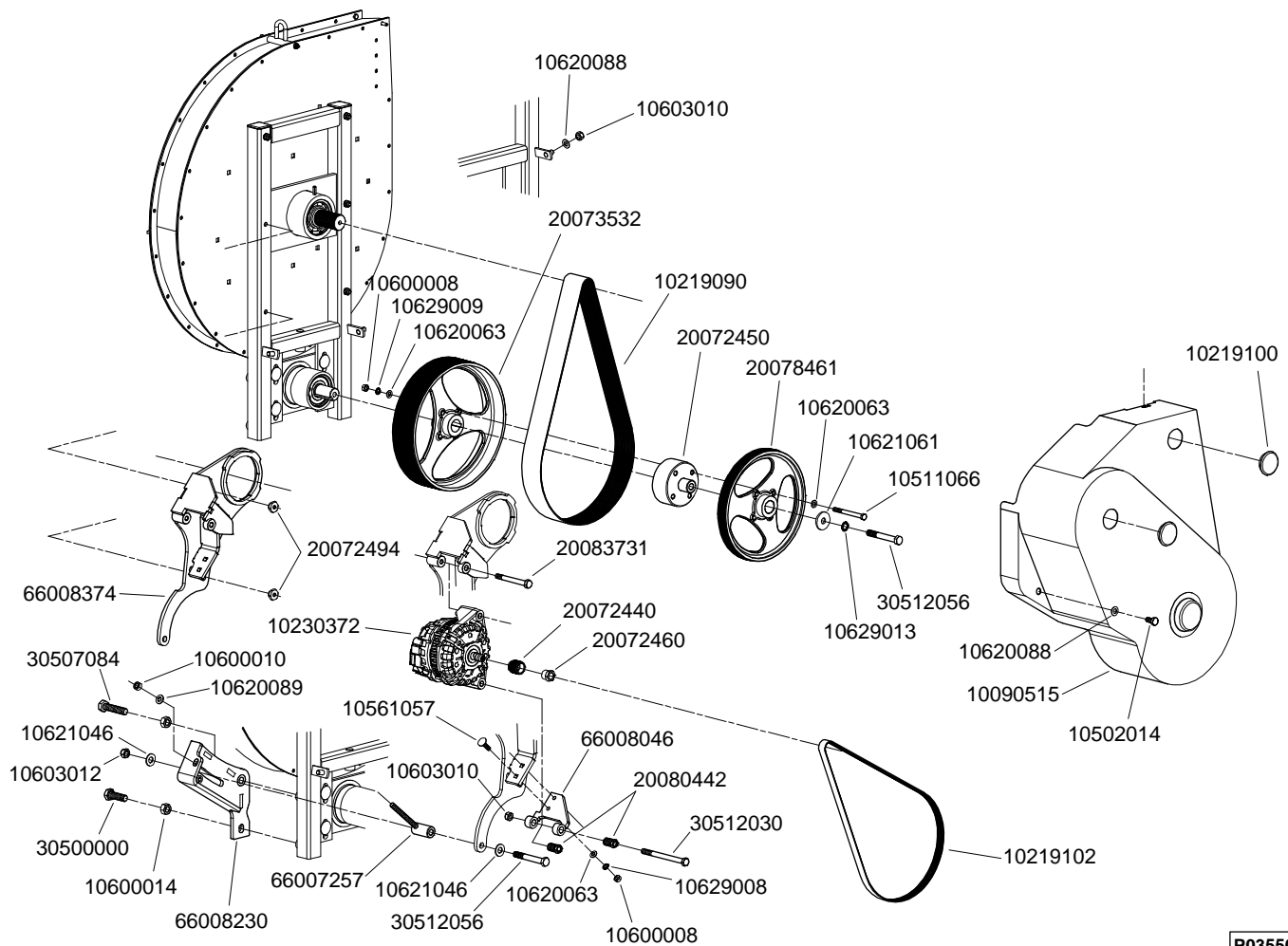

P03550100

Réf. OLD	Réf. NEW	Désignation	Réf. OLD	Réf. NEW	Désignation
	10090515	Cartier de courroie (turbine TGD)		30512056	Vis H M12 x 90
	10219100	Bouchon pour carter		66007257	Tendeur entrainement alternateur (turbine MD et GD)
	10219102	Courroie pour poulie Ø28		66008046	Support douille de réglage
	10219090	Courroie pour poulie Ø290		66008230	Support fixation alternateur (turbine TGD)
	10230372	Alternateur avec excitation (BOSCH)		66008374	Support mobile d'alternateur (turbine TGD)
	10502014	Vis H M10 x 20			
	10511066	Vis H M8 x 90			
	10561057	Vis TRCC M8 x 30			
	10600008	Écrou H M8			
	10600010	Écrou H M10			
	10600014	Écrou H M14			
	10603010	Écrou frein H M10			
	10603012	Écrou frein H M12			
	10620063	Rondelle Ø8,5 x 16 x 1,5			
	10620088	Rondelle Ø10,5 x 20 x 1,5			
	10620089	Rondelle Ø10,5 x 20 x 2			
	10621046	Rondelle Ø13 x 27 x 2			
	10621061	Rondelle Ø13 x 40 x 4			
	10629008	Rondelle AZ Ø8 inox			
	10629009	Rondelle AZ Ø8			
	10629013	Rondelle AZ Ø13			
	20072440	Poulie motrice 8 gorges Ø28			
	20072450	Entretoise de poulie réceptrice			
	20072460	Écrou de serrage poulie motrice (alternateur)			
	20072494	Écrou de serrage support mobile d'alternateur			
	20073532	Poulie 25 groges (turbine TGD)			
	20078461	Poulie réceptrice 8 gorges			
	20080442	Vis de réglage position alternateur			
	20083731	Axe de support mobile			
	30500000	Vis H M14 x 45			
	30507084	Vis H M14 x 65			
5687	30512030	Vis H M10 x 130			

## ACCESSOIRES ÉLECTRIQUE NG Plus M<sub>E</sub> (2)

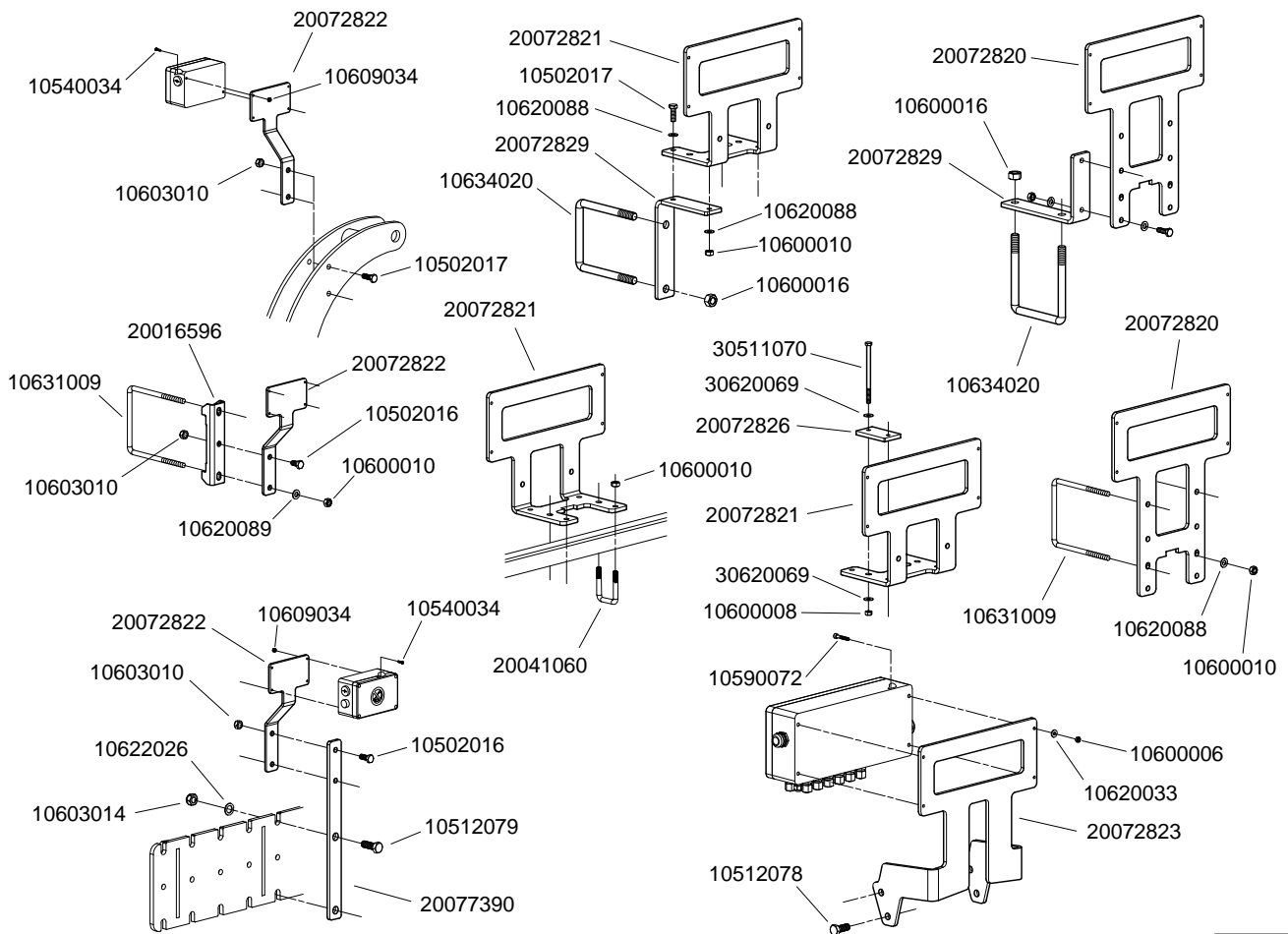

P04090020

Réf. OLD	Réf. NEW	Désignation	Réf. OLD	Réf. NEW	Désignation
	10502016	Vis H M10 x 25			
	10502017	Vis H M10 x 30			
	10512078	Vis H M14 x 35			
	10512079	Vis H M14 x 40			
	10540034	Vis TC M4 x 20			
	10590072	Vis CHC M6 x 35			
	10600006	Écrou H M6			
	10600008	Écrou H M8			
	10600010	Écrou H M10			
	10600016	Écrou H M16			
	10603010	Écrou frein M10			
	10603014	Écrou frein M14			
	10609034	Écrou frein M4 inox			
	10620088	Rondelle Ø10,5 x 20 x 1,5			
	10622026	Rondelle Ø16,5 x 26 x 2			
4647	10631009	Bride de serrage en U M10 (carré de 127)			
4502	10634020	Bride de serrage en U M16			
	20016596	Bride de fixation support Boitier de jonction			
9471	20041060	Bride de serrage en U M10 (40090207)			
	20072820	Support ECU principal V1			
	20072821	Support ECU principal V2			
	20072822	Support boitier de raccordement latéral			
	20072823	Support ECU principal sur châssis repliable DB			
	20072829	Équerre de fixation support ECU principale			
	20077390	Plat de fixation pour support boitier latéral			
	30620069	Rondelle Ø8,5 x 20 x 1,5			

## ACCESSOIRES ÉLECTRIQUE NG Plus ME (1)

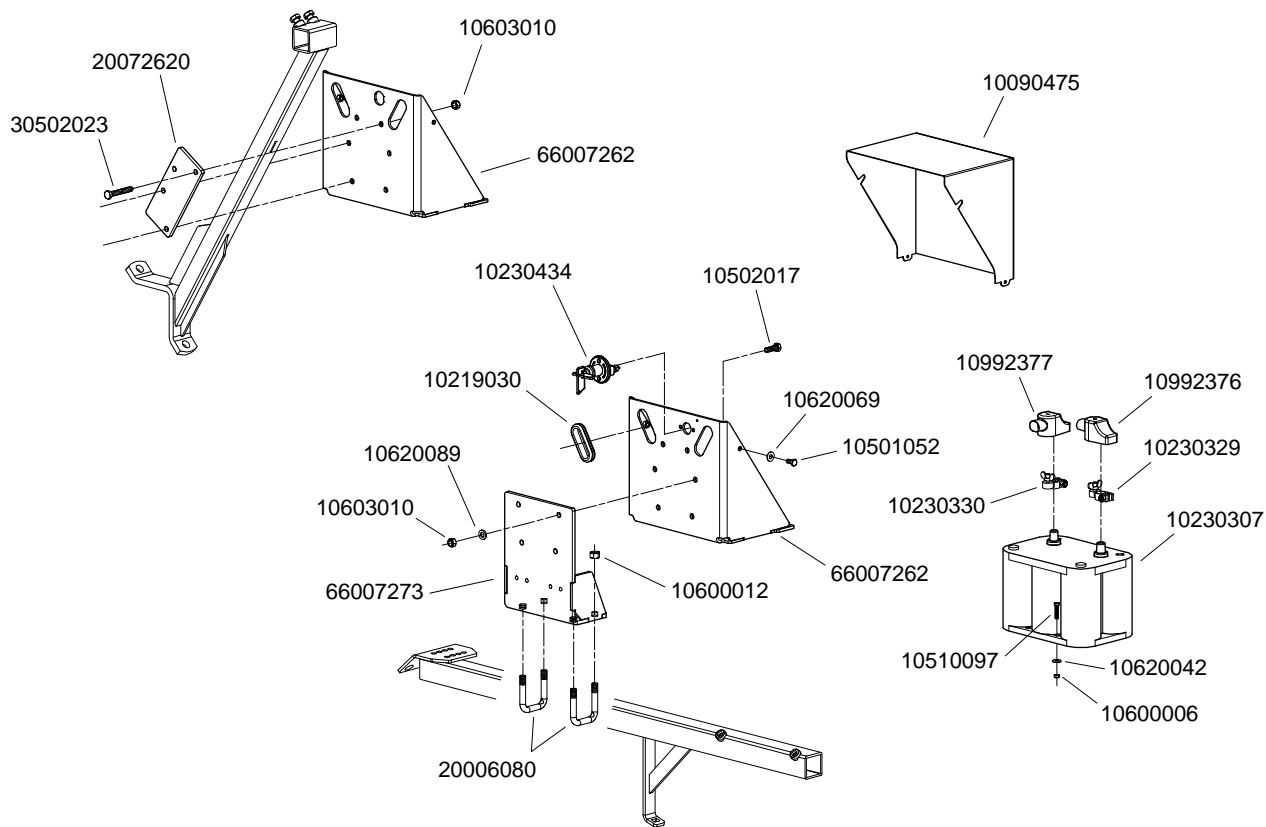

P04090012

Réf. OLD	Réf. NEW	Désignation	Réf. OLD	Réf. NEW	Désignation
	10090475	Carter de protection batterie			
4682	10219030	Passer cloison			
	10230307	Batterie 50AH/815A			
	10230330	Cosse de batterie (-)			
	10230329	Cosse de batterie (+)			
	10230434	Coupe batterie			
	10501052	Vis H M8 x 16			
	10502017	Vis H M10 x 30			
	10510097	Vis H M6 x 30			
	10600006	Écrou H M6			
	10600012	Écrou H M12			
	10603010	Écrou frein M10			
	10620042	Rondelle Ø6,5 x 18 x 2			
	10620069	Rondelle Ø8,5 x 20 x 1,5			
	10620089	Rondelle Ø10,5 x 20 x 1,5			
	10992376	Cache de protection rouge pour cosse (+)			
	10992377	Cache de protection noir pour cosse (-)			
4295	20006080	Bride de serrage en U M12 (40130102)			
	20072620	Contre plaque de fixation support batterie			
	30502023	Vis H M10 x 65			
	66007262	Support batterie			
	66007273	Fixation support batterie			

## SUPPORT RADAR TIP & TOP

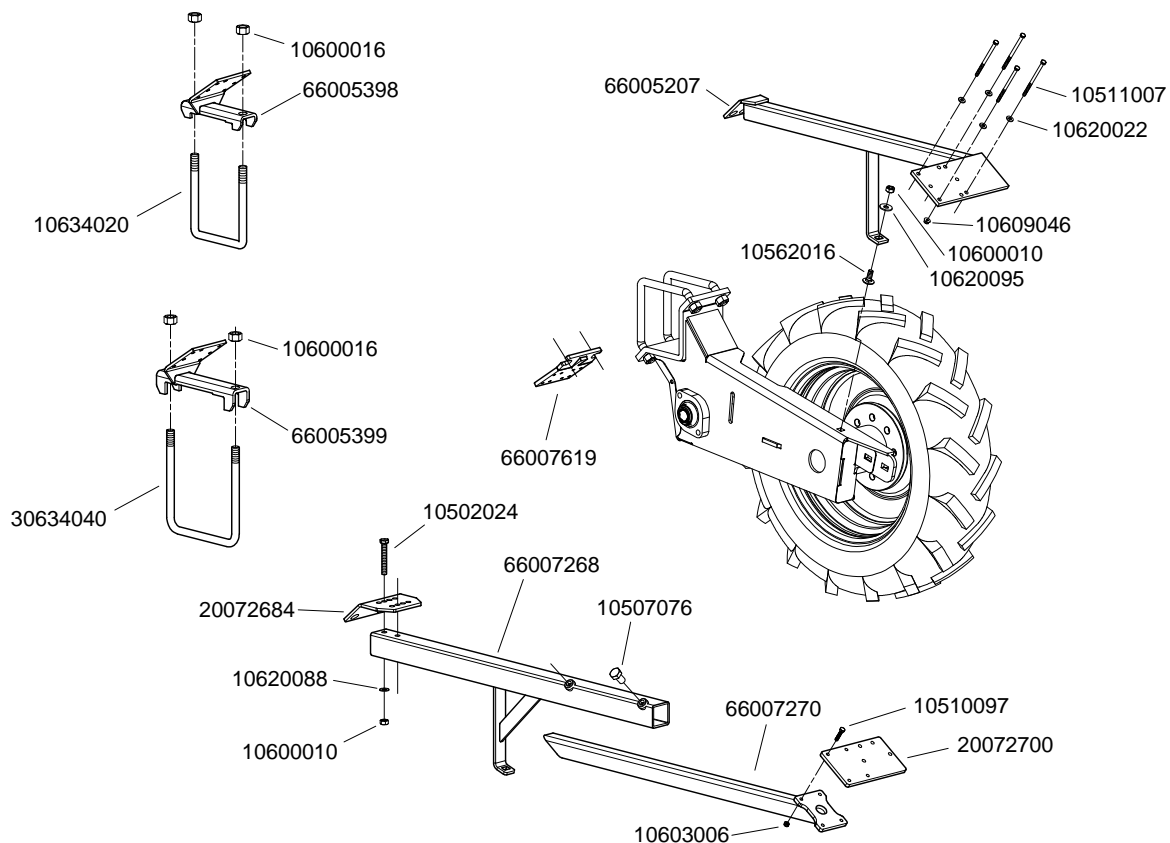

P04010162

Réf. OLD	Réf. NEW	Désignation	Réf. OLD	Réf. NEW	Désignation
	10502024	Vis H M10 x 70			
	10507076	Vis H M14 x 25			
	10510097	Vis H M6 x 30			
	10511007	Vis H M6 x 100			
	10562016	Vis TRCC M10 x 25			
	10600010	Écrou H M10			
	10600016	Écrou H M16			
	10603006	Écrou frein M6			
	10609046	Écrou à embase H M6			
	10620022	Rondelle Ø6.5 x 15 x 1.5			
	10620088	Rondelle Ø10.5 x 20 x 1,5			
	10620095	Rondelle Ø10.5 x 27 x 2			
4502	10634020	Bride de serrage en U Ø16 carré de 127			
	20072684	Plat embase fixation support radar renforcé			
	20072700	Plaque fixation radar			
4885.1	30634040	Bride de serrage en U Ø16 carré 7"			
	66005207	Support radar sur bloc roue standard			
	66005398	Support radar sur barre TIP			
	66005399	Support radar sur barre TOP			
	66007268	Support radar télescopique renforcé			
	66007270	Embout télescopique fixation radar			
	66007619	Support radar bride de bloc roue			

# CAPTEUR ÉLÉMENT NG Plus M S7000 - S8000E

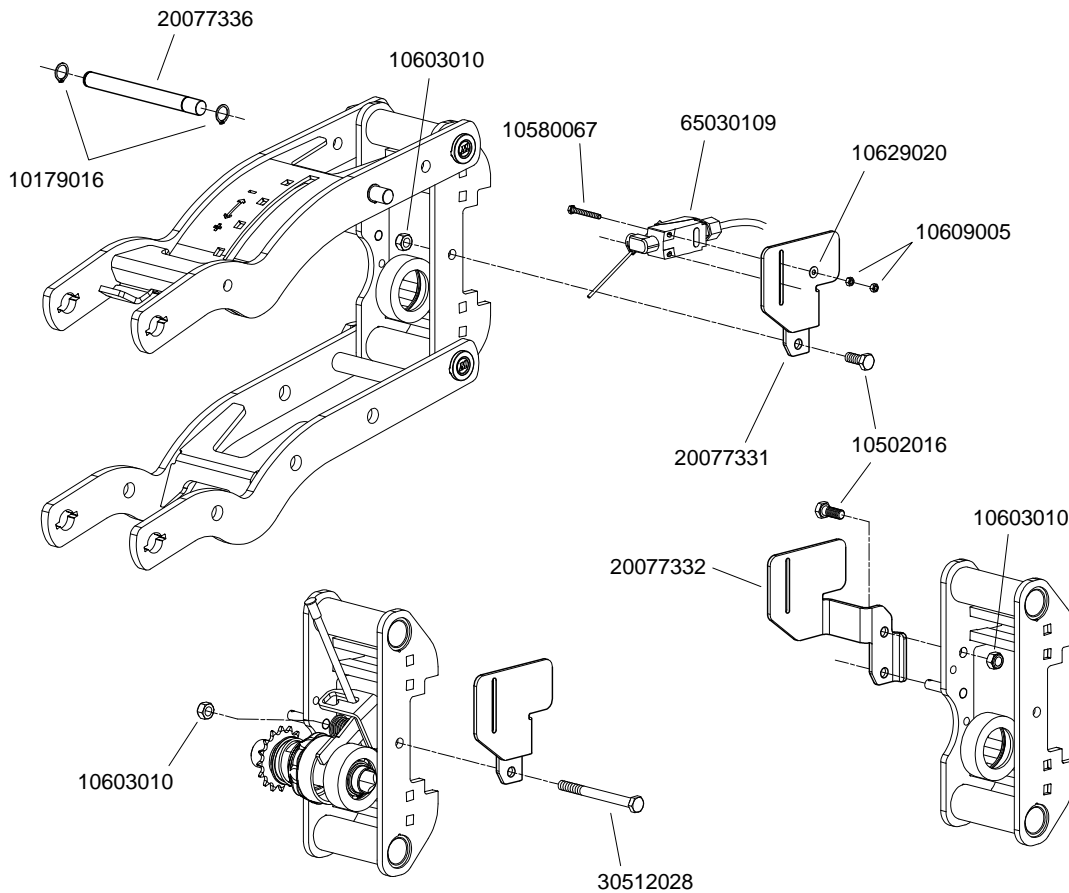

P06160110

Réf. OLD	Réf. NEW	Désignation	Réf. OLD	Réf. NEW	Désignation
	10179016	Anneau élastique extérieur Ø16			
	10502016	Vis H M10 x 25			
	10580067	Vis H M5 x 40 inox			
	10603010	Écrou frein M10			
	10609005	Écrou H M5 inox			
	10629020	Rondelle Ø5 x 12 x 1			
	20077331	Support capteur droit sur élément NG Plus M			
	20077332	Support capteur gauche sur élément NG Plus M			
	20077336	Axe de ressort rallongé pour capteur			
	30512028	Vis H M10 x 110			
	65030109	Capteur de position (ZCP27)			

# CAPTEUR ÉLÉMENT NG Plus 4 S7000 - S8000E

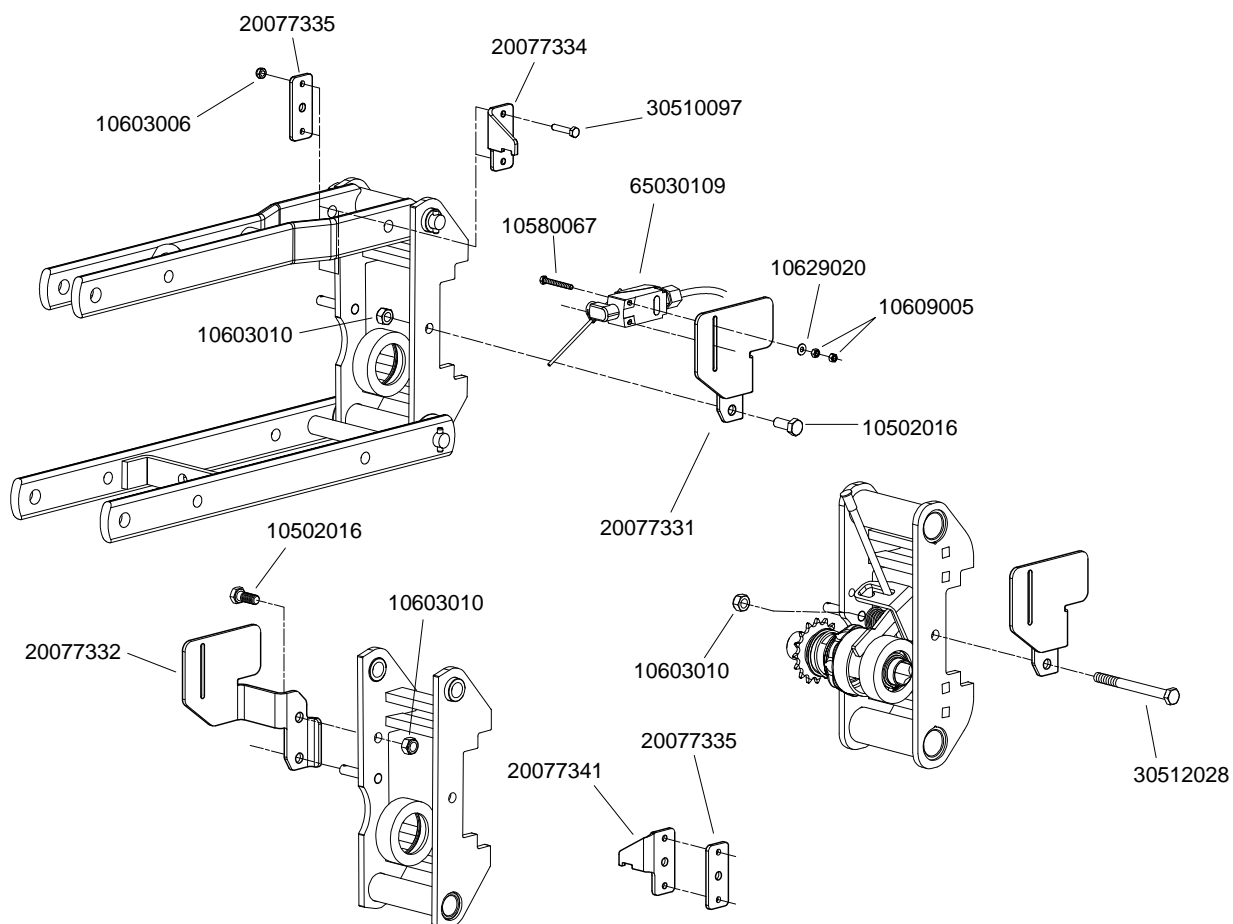

P06150340

Réf. OLD	Réf. NEW	Désignation	Réf. OLD	Réf. NEW	Désignation
	10502016	Vis H M10 x 25			
	10580067	Vis H M5 x 40 inox			
	10603006	Écrou frein M6			
	10603010	Écrou frein M10			
	10609005	Écrou H M5 inox			
	10629020	Rondelle Ø5 x 12 x 1			
	20077331	Support capteur droit sur élément NG Plus M			
	20077332	Support capteur gauche sur élément NG Plus M			
	20077334	Actionneur droit - élément NG Plus 4			
	20077335	Contre bride pour actionneur			
	20077341	Actionneur gauche - élément NG Plus 4			
	30512028	Vis H M10 x 110			
	65030109	Capteur de position (ZCP27)			



# CAPTEUR ÉLÉMENT MECA V4 S7000 - S8000E

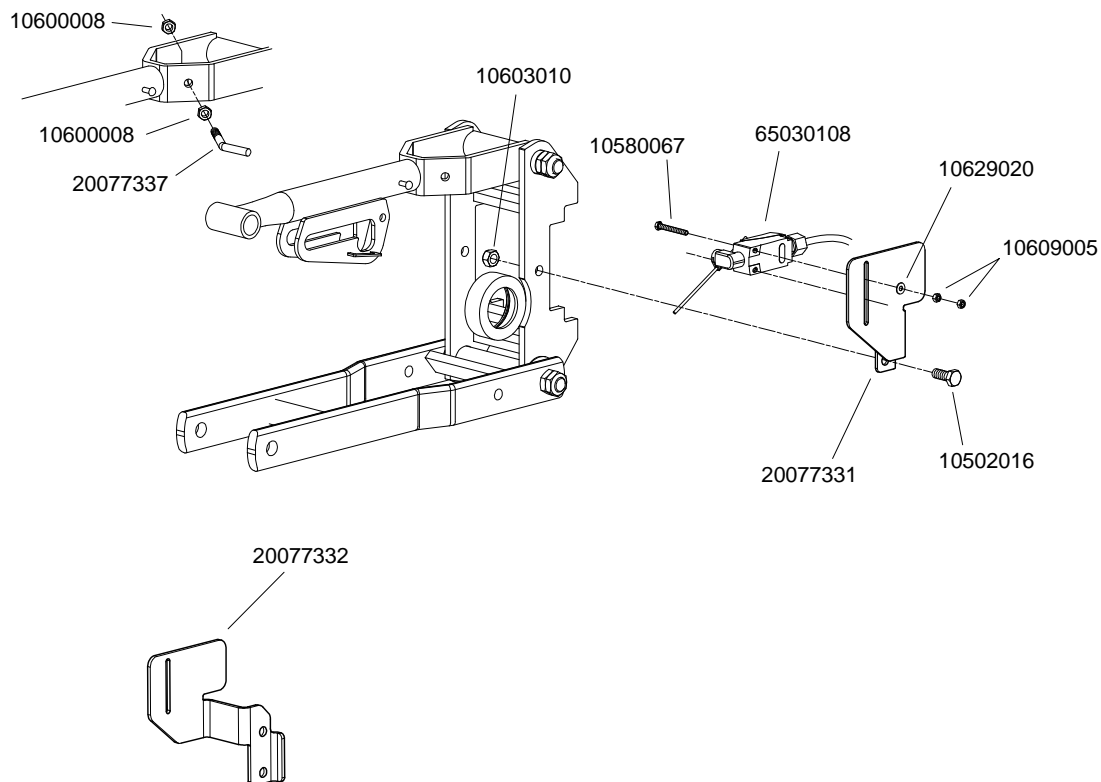

P06040160

Réf. OLD	Réf. NEW	Désignation	Réf. OLD	Réf. NEW	Désignation
	10502016	Vis H M10 x 25			
	10580067	Vis H M5 x 40 inox			
	10600008	Écrou H M8			
	10603010	Écrou frein M10			
	10609005	Écrou H M5 inox			
	10629020	Rondelle Ø5 x 12 x 1			
	20077331	Support capteur droit sur élément NG Plus M			
	20077332	Support capteur gauche sur élément NG Plus M			
	20077337	Actionneur pour capteur			
	65030108	Capteur de position (ZCP28)			

## CAPTEUR ÉLÉMENT NX M S7000 - S8000E

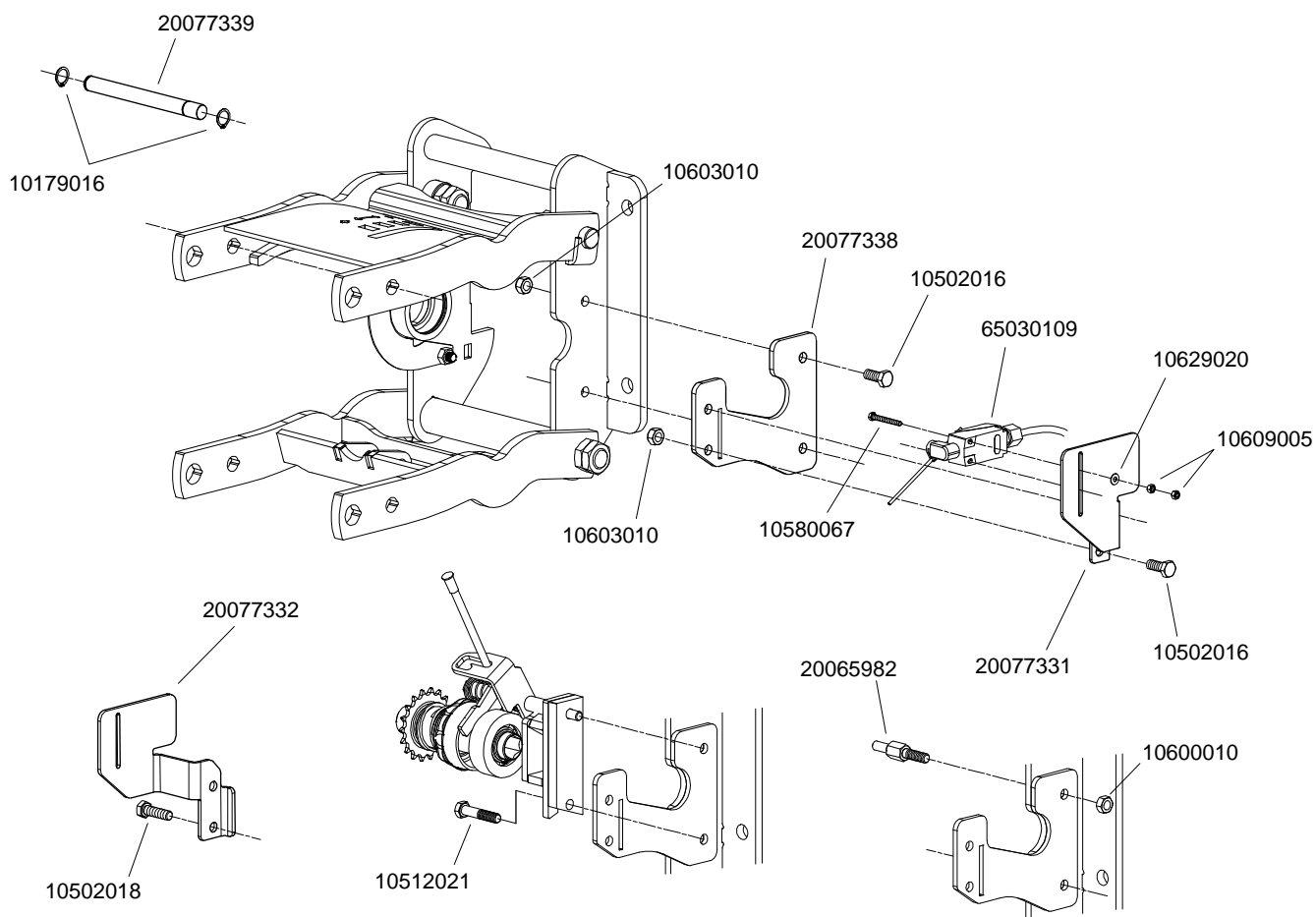

P06180060

Réf. OLD	Réf. NEW	Désignation	Réf. OLD	Réf. NEW	Désignation
	10179016	Anneau élastique extérieur Ø16			
	10502016	Vis H M10 x 25			
	10502018	Vis H M10 x 35			
	10512021	Vis H M10 x 50			
	10580067	Vis H M5 x 40 inox			
	10600010	Écrou H M10			
	10603010	Écrou frein M10			
	10609005	Écrou H M5 inox			
	10629020	Rondelle Ø5 x 12 x 1			
	20065982	Vis de bras de couple - coupure de rangs NX			
	20077331	Support capteur droit sur élément NG Plus M			
	20077332	Support capteur gauche sur élément NG Plus M			
	20077338	Déport de support capteur			
	20077339	Axe d'amortisseur rallongé pour capteur			
	65030109	Capteur de position (ZCP27)			

# ENSEMBLE CELLULES DE CONTRÔLEUR - DICKEY JOHN

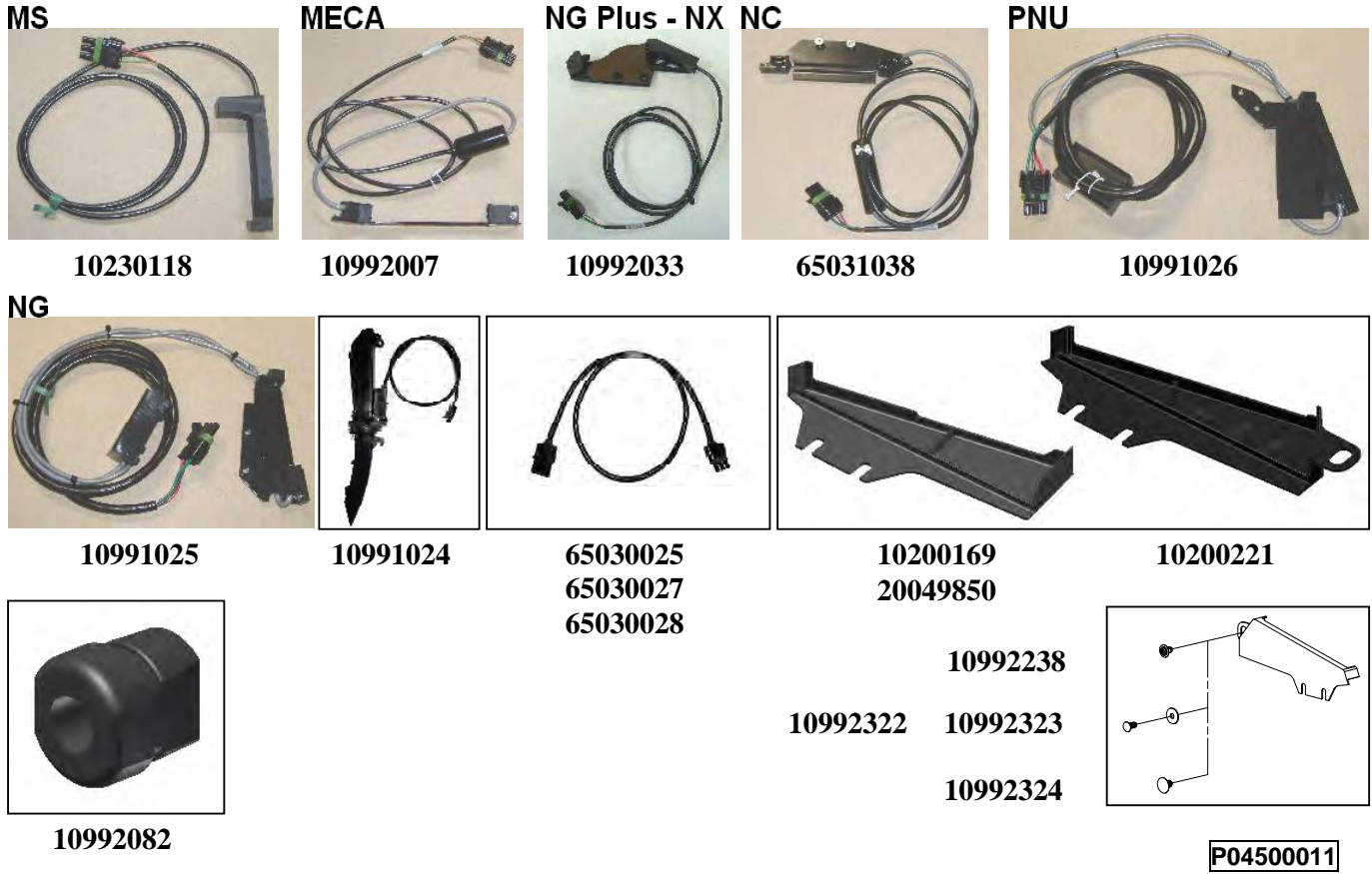

Réf. OLD	Réf. NEW	Désignation	Réf. OLD	Réf. NEW	Désignation
7263	10200169	Carter de protection cellule NG Plus			
	10200221	Carter de protection cellule NG Plus et NX			
	10230118	Cellule MS			
	10991024	Cellule goulotte NG Plus et NX			
	10991025	Cellule NG			
	10991026	Cellule PNU			
	10992007	Cellule MECA			
	10992033	Cellule NG Plus et NX sur boîtier			
	10992082	Douille passe fil			
	10992238	Clou plastique Ø8			
	10992322	Clip sapin pour trou Ø8			
	10992323	Rondelle plate pour clip sapin			
	10992324	Clip sapin pour trou Ø10			
	20049850	Carter plastique de protection cellule NX			
	65030025	Rallonge 3 voies - 1m			
	65030027	Rallonge 3 voies - 5m			
	65030028	Rallonge 3 voies - 2m			
	65031038	Cellule NC			

# NOTES

.....

.....

.....

.....

.....

.....

.....

.....

.....

.....

.....

.....

.....

.....

.....

.....

.....

.....

.....

.....

.....

.....

.....



Par soucis d'amélioration continue de notre production, nous nous réservons le droit de modifier sans préavis nos matériels qui, de ce fait, pourront par certains détails être différents de ceux décrits sur cette notice.



Photographies non contractuelles.

# NOTES

.....

.....

.....

.....

.....

.....

.....

.....

.....

.....

.....

.....

.....

.....

.....

.....

.....



Par soucis d'amélioration continue de notre production, nous nous réservons le droit de modifier sans préavis nos matériels qui, de ce fait, pourront par certains détails être différents de ceux décrits sur cette notice.



Photographies non contractuelles.

# NOTES

.....

.....

.....

.....

.....

.....

.....

.....

.....

.....

.....

.....

.....

.....

.....

.....

.....

.....

.....

.....

.....

.....



Par soucis d'amélioration continue de notre production, nous nous réservons le droit de modifier sans préavis nos matériels qui, de ce fait, pourront par certains détails être différents de ceux décrits sur cette notice.



Photographies non contractuelles.

**IMPORTANT** : A cause de leur utilisation nos semoirs ne sont d'origine pourvus d'aucun équipement de signalisation. Nous rappelons cependant aux utilisateurs que dans le cas où ils auraient un déplacement routier à effectuer ils devraient auparavant mettre leur appareil en conformité avec le code de la route par un équipement signalétique en rapport avec l'encombrement.

**IMPORTANT** : Because of their purpose, our seeders are not fitted with any signals. However, we would like to remind users that if they are planning to transport their seeder on the public road they must first ensure that the equipment complies with the Highway Code by fitting it with signals suitable for its size.

**IMPORTANTE**: A causa de su uso, nuestras sembradoras de origen no cuentan con ningún equipo de señalización. No obstante, recordamos a los usuarios que en caso de tener que realizar desplazamientos por carretera, deberán cumplir con lo dispuesto por el código de circulación usando un equipo de señalización acorde con el espacio ocupado.

**IMPORTANTE**: Dato il loro utilizzo, le nostre seminatrici sono sprovviste di qualsiasi apparecchiatura di segnalazione. Si ricorda tuttavia agli utenti che nel caso in cui si debba effettuare uno spostamento stradale, occorre prima mettere l'apparecchio in conformità con il codice stradale dotandolo di un'attrezzatura di segnalazione adeguata all'ingombro.

#### **EXTRAIT DES CONDITIONS GENERALES DE VENTE COMPAGNIE RIBOULEAU**

Les conditions générales ne sont applicables qu'aux concessionnaires ou revendeurs assurant normalement les services indispensables : montage, livraison, mise en route du matériel neuf, stockage des pièces de rechange, service après-vente, dépannage et reprise éventuelle du vieux matériel.

Notre garantie comprend le remplacement des pièces reconnues défectueuses (hors pièces d'usure) et la ristourne service. Nous ne pourrions en aucun cas être reconnus responsables d'une mauvaise utilisation ou de la non-vérification du bon fonctionnement de l'ensemble du matériel au moment de la mise en service et en cours de campagne. Les revendeurs ou utilisateurs ne pourront prétendre à aucune autre indemnisation de notre part pour les préjudices éventuels qu'ils pourraient subir (frais de main d'œuvre ou d'approche, travail défectueux, accidents matériels ou corporels, manque à gagner sur la récolte, etc.). La garantie est subordonnée au retour du certificat de garantie et de mise en route dûment rempli par le distributeur et l'utilisateur.

Toute pièce faisant l'objet d'une demande de garantie devra nous être adressée en port payé et accompagnée du formulaire de demande de garantie à LARGEASSE (RIBOULEAU MONOSEM) pour analyse. Un échange à neuf, une réparation ou un avoir sera établi si acceptation de la garantie. Le démontage et le remontage seront pris en charge par le revendeur dans le cadre du service normal.

#### **EXTRACT FROM COMPAGNIE RIBOULEAU'S GENERAL SALES TERMS AND CONDITIONS**

The general conditions are only applicable to dealers or distributors usually providing essential services: assembly, delivery, starting up of new equipment, stocking of spare parts, after-sales services, corrective maintenance and possible trading in of old equipment.

Our warranty includes replacement of parts acknowledged to be faulty (excluding wearing parts) and the service discount. Under no circumstances may we be held liable for improper use or a failure to check that all the equipment is working correctly on commissioning and during sowing. Distributors or users are not entitled to compensation from us for any damages that they may incur (labour costs or travel allowances, faulty work, material damage or personal injury, harvest failure, etc). The warranty is subject to the return of the certificate of warranty and commissioning completed by the distributor and the user.

Any part subject to a warranty claim must be sent to us prepaid and accompanied by a complete warranty claim to LARGEASSE (RIBOULEAU MONOSEM) for inspection. An exchange for new part, repair or credit note will be made out if the warranty is accepted. Disassembly and reassembly will be covered by the dealer as part of normal service.

#### **EXTRACTO DE LAS CONDICIONES GENERALES DE VENTA DE LA EMPRESA RIBOULEAU**

Las condiciones generales solo se aplican a los concesionarios o revendedores que normalmente prestan los servicios indispensables: montaje, entrega, puesta en marcha de material nuevo, almacenamiento de piezas de recambio, servicio post-venta, servicio de reparación y posible recogida de material viejo.

Nuestra garantía comprende la sustitución de las piezas reconocidas como defectuosas (excepto piezas de desgaste) y la bonificación de servicio. En ningún caso podremos ser considerados como responsables de un mal uso o de la falta de verificación del buen funcionamiento de todo el material en el momento de la puesta en servicio y durante la campaña. Los revendedores o usuarios no podrán pretender ninguna otra indemnización por parte nuestra por los perjuicios que se les haya podido causar (gastos de mano de obra o de desplazamiento, trabajo defectuoso, accidentes con daños materiales o personales, pérdida de beneficios en la cosecha, etc.). La garantía está subordinada a la devolución del certificado de garantía y de puesta en marcha debidamente cumplimentado por el distribuidor y el usuario.

Nos deberán enviar a Largeasse (RIBOULEAU MONOSEM) las piezas que sean objeto de reclamación de garantía para su análisis, con portes pagados y acompañadas del formulario de reclamación de garantía. Si se acepta la garantía se concederá un cambio por una pieza nueva o bien se realizará una reparación o se emitirá una nota de abono. El desmontaje y posterior montaje correrá por cuenta del revendedor en el marco del servicio normal.

#### **ESTRATTO DELLE CONDIZIONI GENERALI DI VENDITA COMPAGNIA RIBOULEAU**

Le condizioni generali sono applicabili soltanto ai concessionari o ai rivenditori che svolgono normalmente i servizi indispensabili: montaggio, consegna, messa in servizio del materiale nuovo, immagazzinaggio dei pezzi di ricambio, servizi di assistenza in garanzia ed eventuale permuta del vecchio materiale.

La nostra garanzia comprende la sostituzione di pezzi riconosciuti difettosi (tranne pezzi di usura) e il nostro sconto per il servizio. Non potremo mai essere riconosciuti come responsabili di un cattivo utilizzo o della mancata verifica del corretto funzionamento dell'insieme del materiale al momento della messa in servizio e durante la campagna. I rivenditori o gli utenti non potranno pretendere nessun altro risarcimento da parte nostra per gli eventuali danni che potrebbero subire (spese di mano d'opera od oneri esterni, lavoro difettoso, incidenti materiali o corporali, perdita di profitto sul raccolto, ecc...) La garanzia è subordinata al rinvio del certificato di garanzia e di messa in servizio debitamente compilato dal distributore e dall'utente.

Qualunque pezzo che è oggetto di una domanda di garanzia ci dovrà essere inviato con porto pagato e corredato del modulo di domanda di garanzia, a Largeasse (RIBOULEAU MONOSEM) per analisi. In caso di accettazione della garanzia, si procederà ad uno scambio con un pezzo nuovo, ad una riparazione o a all'emissione di un saldo creditore. Lo smontaggio e il rimontaggio saranno presi a carico dal rivenditore nell'ambito del servizio normale.



Par souci d'amélioration continue de notre production, nous nous réservons le droit de modifier sans préavis nos matériels qui, de ce fait, pourront par certains détails être différents de ceux décrits sur cette notice. D'autre part, les instructions de cette notice sont destinées à nos semoirs complets, elles ne concernent pas les sous-ensembles utilisés seuls ou sur d'autres machines.



With the aim of continuously improving our products, we reserve the right to modify our equipment without notice. As a result, some elements may differ from those described in these instructions. In addition, these instructions apply to our complete seeders and do not concern sub-assemblies used alone or on other machines.



Al objeto de mejorar continuamente nuestra producción, nos reservamos el derecho de modificar sin previo aviso el material que en ciertos detalles pudiese ser diferente al descrito en estas instrucciones. Por otra parte, las instrucciones aquí recogidas están destinadas a nuestras sembradoras completas, sin que puedan aplicarse a los subconjuntos utilizados solos o en otras máquinas.



Al fine di migliorare continuamente la nostra produzione, ci riserviamo il diritto di modificare senza preavviso i nostri materiali; per questo motivo alcuni particolari potranno differire da quanto descritto in questa specifica. D'altronde, le istruzioni della specifica riguardano le nostre seminatrici complete e non i sottoinsiemi utilizzati singolarmente o in altre macchine.





*... et pour tous vos travaux de binage et sarclage*

*Consultez-nous !*

*... and for all your cultivating and hoeing.*

*Please consult us !*

Les bineuses

The cultivators

**SUPER-CROP**



**MONOSEM**

COMPAGNIE COMMERCIALE RIBOULEAU  
15, rue Beaujon – 75008 PARIS

Usines – Technique – Recherche – Informations  
12, rue Edmond Riboulet – 79240 LARGEASSE France  
TEL. 05 49 81 50 00 – FAX. 05 49 72 09 70

[www.monosem.com](http://www.monosem.com)

Revendeur :